



These computer programs (including software design, programming structure, graphics, manual, and on-line help) have been created by pcaStructurePoint, the Engineering Software Group of the Portland Cement Association.

While the Portland Cement Association has taken every precaution to utilize the existing state-of-the-art and to assure the correctness of the analytical solution techniques used in these programs, the responsibilities for modeling the structure, inputting data, applying engineering judgment to evaluate the output, and implementing engineering drawings remain with the structural engineer of record. Accordingly, Portland Cement Association does and must disclaim any and all responsibility for defects or failures of structures in connection with which these programs are used.

© 2000 – 2006 Portland Cement Association. All Rights Reserved.

pcaSlab and pcaBeam are trademarks of the Portland Cement Association

Microsoft and Windows are registered trademarks of the Microsoft Corporation.

SentinellM is a registered trademark of SafeNet Inc.

Wise Installation System is a registered trademark of Wise Solutions, Inc.

Other product and company names mentioned herein may be the trademarks of their respective owners.

Table of Contents

Chapter 1 Introduction	1-1
Program Features	pcaslabpcabeam 1-1
Program Capacity	pcaslabpcabeam 1-2
System Requirements	pcaslabpcabeam 1-2
Operating systems.....	pcaslabpcabeam 1-2
Minimum Requirements.....	pcaslabpcabeam 1-3
Recommended Options.....	pcaslabpcabeam 1-3
Terms	pcaslabpcabeam 1-3
Conventions.....	pcaslabpcabeam 1-4
Installing pcaSlab/pcaBeam	pcaslabpcabeam 1-5
Purchasing and Licensing Process	pcaslabpcabeam 1-12
Licensing Model.....	pcaslabpcabeam 1-12
Evaluation Mode	pcaslabpcabeam 1-12
How to Purchase	pcaslabpcabeam 1-13
License Activation	pcaslabpcabeam 1-13
Activation by Phone.....	pcaslabpcabeam 1-15
Activation by E-mail	pcaslabpcabeam 1-16
Running the Program	pcaslabpcabeam 1-17
Removing the Program	pcaslabpcabeam 1-17
Chapter 2 Method of Solution	2-1
Geometric checks.....	pcaslabpcabeam 2-1
Code Checks	pcaslabpcabeam 2-2
Drop Panel Dimensions	pcaslab 2-2
Minimum Slab Thickness.....	pcaslab 2-4
Minimum Thickness for Waffle Slab Systems	pcaslab 2-5
Waffle Rib Dimensions.....	pcaslab 2-6
Special Considerations for Waffle Slabs	pcaslab 2-6
Material Properties	pcaslabpcabeam 2-8
The Equivalent Frame Method.....	pcaslab 2-10
Stiffness Characteristics	pcaslab 2-12
Slab Beams	pcaslab 2-12
Columns	pcaslab 2-12
Loading	pcaslabpcabeam 2-18

Self-Weight	pcaSlab pcaBeam ...	2-18
Superimposed Loading	pcaSlab pcaBeam ...	2-18
Lateral Loading	pcaSlab pcaBeam ...	2-19
Loading Patterns	pcaSlab pcaBeam ...	2-19
Load Combinations	pcaSlab pcaBeam ...	2-21
Column and Middle Strip Widths	pcaSlab ...	2-22
Strip Design Moments	pcaSlab ...	2-25
Moment Redistribution	pcaSlab pcaBeam ...	2-28
Shear Analysis of Slabs	pcaSlab ...	2-29
Critical Section for Interior Supports of Interior Frames	pcaSlab ...	2-31
Critical Section for Exterior Supports of Interior Frames	pcaSlab ...	2-32
Critical Section for Interior Supports of Exterior Frames	pcaSlab ...	2-33
Critical Section for Exterior Supports of Exterior Frames	pcaSlab ...	2-34
Computation of Allowable Shear Stress at Critical Section	pcaSlab ...	2-34
Computation of Factored Shear Force at Critical Section	pcaSlab ...	2-35
Computation of Unbalanced Moment at Critical Section	pcaSlab ...	2-35
Computation of Shear Stresses at Critical Section	pcaSlab ...	2-35
Shear Resistance at Corner Columns	pcaSlab ...	2-37
Shear Analysis of Longitudinal Beams	pcaSlab pcaBeam ...	2-37
Torsion and Shear	pcaSlab pcaBeam ...	2-39
Area of Reinforcement	pcaSlab pcaBeam ...	2-43
Reinforcement Selection	pcaSlab pcaBeam ...	2-46
Additional Reinforcement at Support	pcaSlab ...	2-50
Integrity Reinforcement	pcaSlab ...	2-51
Corner Reinforcement	pcaSlab ...	2-51
Deflections	pcaSlab pcaBeam ...	2-52
Deflections of two-ways systems	pcaSlab ...	2-52
Deflections of beam and one-way systems	pcaSlab pcaBeam ...	2-53
Cracking	pcaSlab pcaBeam ...	2-54
Instantaneous Deflections	pcaSlab pcaBeam ...	2-56
Long Time Deflections	pcaSlab pcaBeam ...	2-56
Material Quantities	pcaSlab pcaBeam ...	2-57
References	pcaSlab pcaBeam ...	2-58
Chapter 3 pcaSlab/pcaBeam Interface		3-1
User Interface Components	pcaSlab pcaBeam ...	3-1
Check Boxes	pcaSlab pcaBeam ...	3-1
Checked Menu Commands	pcaSlab pcaBeam ...	3-1
Command Buttons	pcaSlab pcaBeam ...	3-1
Control Menu	pcaSlab pcaBeam ...	3-2
Dialog Boxes	pcaSlab pcaBeam ...	3-2

Drop-down List	pcAslab pcAbeam	3-2
Drop-down Menu	pcAslab pcAbeam	3-3
Enable/Disable Options	pcAslab pcAbeam	3-3
Frame Boxes	pcAslab pcAbeam	3-3
List Boxes	pcAslab pcAbeam	3-3
Option Buttons	pcAslab pcAbeam	3-5
Pop-up Menu	pcAslab pcAbeam	3-5
Tabs	pcAslab pcAbeam	3-5
Text Boxes	pcAslab pcAbeam	3-6
Main Window	pcAslab pcAbeam	3-6
Title Bar	pcAslab pcAbeam	3-7
Menu Bar	pcAslab pcAbeam	3-7
Tool Bar	pcAslab pcAbeam	3-8
View Windows	pcAslab pcAbeam	3-8
Status Bar	pcAslab pcAbeam	3-9
File Menu	pcAslab pcAbeam	3-10
New	pcAslab pcAbeam	3-10
Open	pcAslab pcAbeam	3-10
Close	pcAslab pcAbeam	3-11
Save	pcAslab pcAbeam	3-11
Save As	pcAslab pcAbeam	3-11
Print Preview	pcAslab pcAbeam	3-11
Print Results	pcAslab pcAbeam	3-12
Printer Setup	pcAslab pcAbeam	3-13
Recent Files	pcAslab pcAbeam	3-13
Exit	pcAslab pcAbeam	3-13
Input Menu	pcAslab pcAbeam	3-13
Data Input Wizard	pcAslab pcAbeam	3-14
General Information	pcAslab pcAbeam	3-14
Material Properties	pcAslab pcAbeam	3-15
Spans	pcAslab pcAbeam	3-15
Supports	pcAslab pcAbeam	3-16
Reinforcement Criteria	pcAslab pcAbeam	3-17
Reinforcement Bars	pcAslab pcAbeam	3-17
Load Cases	pcAslab pcAbeam	3-18
Load Combinations	pcAslab pcAbeam	3-19
Span Loads	pcAslab pcAbeam	3-19
Support Loads and Displacements	pcAslab pcAbeam	3-20
Lateral Effects	pcAslab pcAbeam	3-20
Solve Menu	pcAslab pcAbeam	3-21

Execute	pca slab pca beam ...	3-21
Results Report	pca slab pca beam ...	3-21
View Menu	pca slab pca beam ...	3-22
Zoom	pca slab pca beam ...	3-22
Pan	pca slab pca beam ...	3-22
Restore	pca slab pca beam ...	3-22
Plan View	pca slab pca beam ...	3-23
Elevated View	pca slab pca beam ...	3-23
Side View	pca slab pca beam ...	3-23
Isometric View	pca slab pca beam ...	3-23
Change View Angles	pca slab pca beam ...	3-23
View Options	pca slab pca beam ...	3-23
Loads	pca slab pca beam ...	3-23
Internal Forces	pca slab pca beam ...	3-23
Moment Capacity	pca slab pca beam ...	3-24
Shear Capacity	pca slab pca beam ...	3-24
Reinforcement	pca slab pca beam ...	3-24
Deflection	pca slab pca beam ...	3-24
Duplicate Active View	pca slab pca beam ...	3-24
Options Menu	pca slab pca beam ...	3-24
Colors	pca slab pca beam ...	3-24
Fonts	pca slab pca beam ...	3-25
Startup Defaults	pca slab pca beam ...	3-25
Reinforcement Database	pca slab pca beam ...	3-26
Toolbar	pca slab pca beam ...	3-26
Status Bar	pca slab pca beam ...	3-26
Window Menu	pca slab pca beam ...	3-26
Cascade	pca slab pca beam ...	3-26
Tile Horizontal	pca slab pca beam ...	3-26
Tile Vertical	pca slab pca beam ...	3-27
Window List	pca slab pca beam ...	3-27
Help Menu	pca slab pca beam ...	3-27
Help Topics	pca slab pca beam ...	3-27
Context Help	pca slab pca beam ...	3-27
About pcaSlab/pcaBeam	pca slab pca beam ...	3-27
The Control Menu	pca slab pca beam ...	3-28
Restore	pca slab pca beam ...	3-28
Move	pca slab pca beam ...	3-28
Size	pca slab pca beam ...	3-28
Minimize	pca slab pca beam ...	3-29

Maximize.....	pcaslab pca beam	3-29
Close.....	pcaslab pca beam	3-29
Next.....	pcaslab pca beam	3-29
Program Toolbar.....	pcaslab pca beam	3-29
Chapter 4 Operating pcaSlab/pcaBeam		4-1
Working with Data Files (menu File)	pcaslab pca beam	4-1
Creating a New Data File	pcaslab pca beam	4-1
Opening Existing Data File.....	pcaslab pca beam	4-1
Importing ADOSS and PCA-Beam Data File	pcaslab pca beam	4-2
Saving the Data File	pcaslab pca beam	4-3
Most Recently Used Files (MRU)	pcaslab pca beam	4-4
Specifying the Model Data (menu Input)	pcaslab pca beam	4-4
Data Input Wizard	pcaslab pca beam	4-4
Defining General Information	pcaslab pca beam	4-4
Defining Solve Option	pcaslab pca beam	4-5
Using Span Control.....	pcaslab pca beam	4-8
Defining Material Properties	pcaslab pca beam	4-12
Defining the Slabs/Flanges	pcaslab pca beam	4-14
Defining the Longitudinal Beams.....	pcaslab pca beam	4-16
Defining the Ribs.....	pcaslab pca beam	4-17
Defining the Columns.....	pcaslab pca beam	4-18
Defining the Drop Panels	pcaslab	4-20
Defining the Column Capitals	pcaslab pca beam	4-22
Defining the Transverse Beams	pcaslab pca beam	4-23
Defining the Boundary Conditions	pcaslab pca beam	4-25
Defining the Moment Redistribution Factors.....	pcaslab pca beam	4-26
Defining the Reinforcement Criteria for Slabs and Ribs	pcaslab pca beam	4-27
Defining the Reinforcement Criteria for Beams	pcaslab pca beam	4-29
Defining Column Strip Bars for Two-Way Slab Systems.....	pcaslab	4-31
Defining Middle Strip Bars for Two-Way Slab Systems	pcaslab	4-32
Defining Beam Bars for Two-Way Slab Systems	pcaslab	4-34
Defining Beam Stirrups for Two-Way Slab Systems.....	pcaslab	4-35
Defining Flexure Bars for Beams and One-Way Slab Systems.....	pcaslab pca beam	4-37
Defining Stirrups for Beams and One-Way Slab Systems	pcaslab pca beam	4-38
Defining Torsional Longitudinal Bars for Beams	pcaslab pca beam	4-38
Defining Load Cases	pcaslab pca beam	4-40
Defining Load Combinations	pcaslab pca beam	4-41
Span Loads.....	pcaslab pca beam	4-42
Defining Area Load on Span.....	pcaslab pca beam	4-44
Defining Line Load on Span	pcaslab pca beam	4-45

Defining Point Force on Span.....	pcAslab pcAbeam ...	4-46
Defining Point Moment on Span.....	pcAslab pcAbeam ...	4-47
Defining Line Torque on Span.....	pcAslab pcAbeam ...	4-49
Defining Point Torque on Span.....	pcAslab pcAbeam ...	4-50
Defining Support Loads and Displacements.....	pcAslab pcAbeam ...	4-51
Defining Lateral Effects.....	pcAslab pcAbeam ...	4-53
Executing the Calculations (menu Solve).....	pcAslab pcAbeam ...	4-54
Execute.....	pcAslab pcAbeam ...	4-54
Viewing Results Report.....	pcAslab pcAbeam ...	4-55
Saving Results Report.....	pcAslab pcAbeam ...	4-55
View Program Output (menu View).....	pcAslab pcAbeam ...	4-57
Zooming in on the Floor System.....	pcAslab pcAbeam ...	4-57
Change the Isometric View Angle.....	pcAslab pcAbeam ...	4-58
Viewing the Specific Member Type.....	pcAslab pcAbeam ...	4-58
Plan View.....	pcAslab pcAbeam ...	4-59
Elevated View.....	pcAslab pcAbeam ...	4-60
Side View.....	pcAslab pcAbeam ...	4-62
Isometric View.....	pcAslab pcAbeam ...	4-63
Loads.....	pcAslab pcAbeam ...	4-65
View Graphical Results.....	pcAslab pcAbeam ...	4-66
Print Results.....	pcAslab pcAbeam ...	4-73
Print Preview.....	pcAslab pcAbeam ...	4-75
Copy Graphs to Clipboard.....	pcAslab pcAbeam ...	4-76
Customizing Program (menu Options).....	pcAslab pcAbeam ...	4-77
Changing Colors.....	pcAslab pcAbeam ...	4-77
Changing Fonts.....	pcAslab pcAbeam ...	4-78
Changing Startup Defaults.....	pcAslab pcAbeam ...	4-80
Changing the Rebar Database.....	pcAslab pcAbeam ...	4-80
Working with View Windows (menu Window).....	pcAslab pcAbeam ...	4-81
Cascade.....	pcAslab pcAbeam ...	4-81
Tile Horizontal.....	pcAslab pcAbeam ...	4-82
Tile Vertical.....	pcAslab pcAbeam ...	4-82
Remaining Commands.....	pcAslab pcAbeam ...	4-82
Obtaining Help Information (menu Help).....	pcAslab pcAbeam ...	4-82
Opening Table of Contents of the Help System.....	pcAslab pcAbeam ...	4-82
Displaying Help Topic Associated with Selected Element.....	pcAslab pcAbeam ...	4-82
Obtaining Information about the Program.....	pcAslab pcAbeam ...	4-82
Chapter 5 Output Description.....		5-1
Output Elements.....	pcAslab pcAbeam ...	5-1
Program Version.....	pcAslab pcAbeam ...	5-1

Input Echo	pcaslab pcabeam	5-1
General Information	pcaslab pcabeam	5-2
Material Properties	pcaslab pcabeam	5-2
Rebar Database	pcaslab pcabeam	5-2
Span Data	pcaslab pcabeam	5-2
Support Data	pcaslab pcabeam	5-2
Load Data	pcaslab pcabeam	5-3
Reinforcement Criteria	pcaslab pcabeam	5-3
Reinforcing Bars	pcaslab pcabeam	5-3
Design Results	pcaslab pcabeam	5-3
Top Reinforcement	pcaslab pcabeam	5-3
Top Bar Details	pcaslab pcabeam	5-4
Bottom Reinforcement	pcaslab pcabeam	5-4
Bottom Bar Details	pcaslab pcabeam	5-5
Flexural Capacity	pcaslab pcabeam	5-5
Longitudinal Beam Shear Reinforcement Required	pcaslab pcabeam	5-5
Longitudinal Beam Shear Reinforcement Details	pcaslab pcabeam	5-6
Beam Shear (and Torsion) Capacity	pcaslab pcabeam	5-6
Slab Shear Capacity	pcaslab	5-6
Flexural Transfer of Negative Unbalanced Moment at Supports	pcaslab	5-6
Punching Shear Around Columns	pcaslab	5-7
Punching Shear Around Drops	pcaslab	5-7
Maximum Deflections	pcaslab pcabeam	5-7
Material Takeoff	pcaslab pcabeam	5-8
Column Axial Forces And Moments	pcaslab pcabeam	5-8
Internal Forces - Load Cases	pcaslab pcabeam	5-8
Internal Forces - Load Combinations	pcaslab pcabeam	5-9
Internal Forces - Envelopes	pcaslab pcabeam	5-9
Deflections	pcaslab pcabeam	5-9
Graphical Output	pcaslab pcabeam	5-9
Chapter 6 Examples		6-1
Example 1 Spandrel beam with moment redistribution	pcaslab pcabeam	6-1
Problem description		6-1
Prepering the input		6-2
Text Output (abbreviated)		6-11
Grphical Output		6-24
Example 2 Spandrel beam with torsion	pcaslab pcabeam	6-30
Problem description		6-30
Program input		6-31

Text Output	6-40
Graphical Output.....	6-51
Example 3 One-way slab system	6-57
Problem description	6-57
Program Input	6-57
Text Output (abbreviated).....	6-66
Graphical Output.....	6-78
Example 4 Flat Plate Floor System	pcAslab 6-86
Problem description	6-86
Program Input	6-87
Text Output (abbreviated).....	6-93
Graphical Output.....	6-103
Example 5 Two-way slab system.....	pcAslab 6-109
Problem description	6-109
Program Input	6-109
Text Output (abbreviated).....	6-117
Graphical Output.....	6-128
Appendix.....	A-1
Conversion Factors - English to SI	A-1
Conversion Factors - SI to English.	A-1
Contact Information	A-2
Bug Report Form	A-3

License Agreements

PORTLAND CEMENT ASSOCIATION EVALUATION SOFTWARE LICENSE AGREEMENT

BY CLICKING THE "I AGREE" ICON BELOW, OR BY INSTALLING, COPYING, OR OTHERWISE USING THE SOFTWARE OR USER DOCUMENTATION, YOU AGREE TO BE BOUND BY THE TERMS OF THIS AGREEMENT, INCLUDING, BUT NOT LIMITED TO, THE WARRANTY DISCLAIMERS, LIMITATIONS OF LIABILITY AND TERMINATION PROVISIONS BELOW. IF YOU DO NOT AGREE TO THE TERMS OF THIS AGREEMENT, DO NOT INSTALL OR USE THE SOFTWARE OR USER DOCUMENTATION, EXIT THIS APPLICATION NOW AND RETURN THE SOFTWARE AND USER DOCUMENTATION TO PCA.

PORTLAND CEMENT ASSOCIATION, 5420 OLD ORCHARD ROAD, SKOKIE, ILLINOIS 60077 (HEREAFTER PCA), GRANTS THE CUSTOMER A PERSONAL, NONEXCLUSIVE, LIMITED, NONTRANSFERABLE LICENSE TO USE THIS SOFTWARE AND USER DOCUMENTATION SOLELY FOR TRIAL AND EVALUATION PURPOSES ONLY IN ACCORDANCE WITH THE TERMS AND CONDITIONS OF THIS AGREEMENT. SOFTWARE AND USER DOCUMENTATION IS SUPPLIED TO CUSTOMER EITHER BY PCA DIRECTLY OR THROUGH AN AUTHORIZED DEALER OF PCA (HEREAFTER DEALER).

WHILE PCA HAS TAKEN PRECAUTIONS TO ASSURE THE CORRECTNESS OF THE ANALYTICAL SOLUTION AND DESIGN TECHNIQUES USED IN THIS SOFTWARE, IT CANNOT AND DOES NOT GUARANTEE ITS PERFORMANCE, NOR CAN IT OR DOES IT BEAR ANY RESPONSIBILITY FOR DEFECTS OR FAILURES IN STRUCTURES IN CONNECTION WITH WHICH THIS SOFTWARE MAY BE USED. DEALER (IF ANY) HAS NOT PARTICIPATED IN THE DESIGN OR DEVELOPMENT OF THIS SOFTWARE AND NEITHER GUARANTEES THE PERFORMANCE OF THE SOFTWARE NOR BEARS ANY RESPONSIBILITY FOR DEFECTS OR FAILURES IN STRUCTURES IN CONNECTION WITH WHICH THIS SOFTWARE IS USED.

PCA AND DEALER (IF ANY) EXPRESSLY DISCLAIM ANY WARRANTY THAT: (A) THE FUNCTIONS CONTAINED IN THE SOFTWARE WILL MEET THE REQUIREMENTS OF CUSTOMER OR OPERATE IN COMBINATIONS THAT MAY BE SELECTED FOR USE BY CUSTOMER; (B) THE OPERATION OF THE SOFTWARE WILL BE FREE OF ALL "BUGS" OR PROGRAM ERRORS; OR (C) THE SOFTWARE CONFORMS TO ANY PERFORMANCE SPECIFICATIONS. CUSTOMER ACKNOWLEDGES THAT PCA IS UNDER NO OBLIGATION TO PROVIDE ANY SUPPORT, UPDATES, BUG FIXES OR ERROR CORRECTIONS TO OR FOR THE SOFTWARE OR USER DOCUMENTATION.

THE LIMITED WARRANTIES IN SECTION 6 HEREOF ARE IN LIEU OF ALL OTHER WARRANTIES, EXPRESS OR IMPLIED, INCLUDING, BUT NOT LIMITED TO, ANY IMPLIED WARRANTIES OF NON-INFRINGEMENT, MERCHANTABILITY OR FIT NESS FOR A PARTICULAR PURPOSE, EACH OF WHICH IS HEREBY DISCLAIMED. EXCEPT AS SET FORTH IN SECTION 6, THE SOFTWARE AND USER DOCUMENTATION ARE PROVIDED ON AN "AS-IS" BASIS.

IN NO EVENT SHALL PCA OR DEALER (IF ANY) BE LIABLE FOR: (A) LOSS OF PROFITS, DIRECT, INDIRECT, INCIDENTAL, SPECIAL, EXEMPLARY, PUNITIVE, CONSEQUENTIAL OR OTHER DAMAGES, EVEN IF PCA OR DEALER (IF ANY) HAS BEEN ADVISED OF THE POSSIBILITY OF SUCH DAMAGES; (B) ANY CLAIM AGAINST CUSTOMER BY ANY THIRD PARTY; OR (C) ANY DAMAGES CAUSED BY (1) DELAY IN DELIVERY OF THE SOFTWARE

OR USER DOCUMENTATION UNDER THIS AGREEMENT; (2) THE PERFORMANCE OR NON PERFORMANCE OF THE SOFTWARE; (3) RESULTS FROM USE OF THE SOFTWARE OR USER DOCUMENTATION, INCLUDING, WITHOUT LIMITATION, MISTAKES, ERRORS, INACCURACIES, FAILURES OR CUSTOMER'S INABILITY TO PROVIDE SERVICES TO THIRD PARTIES THROUGH USE OF THE SOFTWARE OR USER DOCUMENTATION; (4) CUSTOMER'S FAILURE TO PERFORM CUSTOMER'S RESPONSIBILITIES; (5) PCA NOT PROVIDING UPDATES, BUG FIXES OR CORRECTIONS TO OR FOR ANY OF THE SOFTWARE OR USER DOCUMENTATION; (6) LABOR, EXPENSE OR MATERIALS NECESSARY TO REPAIR DAMAGE TO THE SOFTWARE OR USER DOCUMENTATION CAUSED BY (a) ACCIDENT, (b) NEGLIGENCE OR ABUSE BY CUSTOMER, (c) ACTS OF THIRD PERSONS INCLUDING, BUT NOT LIMITED TO, INSTALLATION, REPAIR, MAINTENANCE OR OTHER CORRECTIVE WORK RELATED TO ANY EQUIPMENT BEING USED, (d) CAUSES EXTERNAL TO THE SOFTWARE SUCH AS POWER FLUCTUATION AND FAILURES, OR (e) FLOODS, WINDSTORMS OR OTHER ACTS OF GOD. MOREOVER, IN NO EVENT SHALL PCA BE LIABLE FOR WARRANTIES, GUARANTEES, REPRESENTATIONS OR ANY OTHER UNDERSTANDINGS BETWEEN CUSTOMER AND DEALER (IF ANY) RELATING TO THE SOFTWARE OR USER DOCUMENTATION.

THIS AGREEMENT CONSTITUTES THE ENTIRE AND EXCLUSIVE AGREEMENT BETWEEN CUSTOMER AND PCA AND DEALER (IF ANY) WITH RESPECT TO THE SOFTWARE AND USER DOCUMENTATION TO BE FURNISHED HEREUNDER. IT IS A FINAL EXPRESSION OF THAT AGREEMENT AND UNDERSTANDING. IT SUPERSEDES ALL PRIOR COMMUNICATIONS BETWEEN THE PARTIES (INCLUDING ANY EVALUATION LICENSE AND ALL ORAL AND WRITTEN PROPOSALS). ORAL STATEMENTS MADE BY PCA'S OR DEALER'S (IF ANY) REPRESENTATIVES ABOUT THE SOFTWARE OR USER DOCUMENTATION DO NOT CONSTITUTE REPRESENTATIONS OR WARRANTIES, SHALL NOT BE RELIED ON BY CUSTOMER, AND ARE NOT PART OF THIS AGREEMENT.

1. LICENSE RESTRICTIONS

- (a) Except as expressly provided in this Agreement or as otherwise authorized in writing by PCA, Customer has no right to: (1) use, print, copy, display, reverse assemble, reverse engineer, translate or decompile the Software or User Documentation in whole or in part; (2) disclose, publish, release, sublicense or transfer to another person any Software or User Documentation; (3) reproduce the Software or User Documentation for the use or benefit of anyone other than Customer; or (4) modify any Software or User Documentation. All rights to the Software and User Documentation not expressly granted to Customer hereunder are retained by PCA. All copyrights and other proprietary rights except as expressed elsewhere in the Software or User Documentation and legal title thereto shall remain in PCA. Customer may use the Software at only one designated workstation at Customer's site at any given time. Customer may not transmit the Software electronically to any other workstation, computer, node or terminal device whether via a local area network, a wide area network, telecommunications transmission, the Internet or other means now known or hereafter created without prior written permission by PCA.
- (b) Customer acknowledges that this is a limited license for trial and evaluation purposes only. This limited license shall automatically terminate upon the earlier of: (1) ten executions of the Software on the computer on which it is installed; or (2) fifteen days after the installation of the Software. Thereafter, Customer may only use the Software and Documentation if it acquires a production license for the same.

2. TERM AND TERMINATION

- (a) This Agreement shall be in effect from the date Customer clicks the "I AGREE" icon below or installs, copies or otherwise uses the Software or User Documentation until: (1) it is terminated by Customer, by Dealer (if any) on behalf of Customer or PCA or by PCA as set forth herein; or (2) the limited trial and evaluation license terminates.
- (b) This Agreement may be terminated by PCA without cause upon 30 days' written notice or immediately upon notice to Customer if Customer breaches this Agreement or fails to comply with any of its terms or conditions. This Agreement may be terminated by Customer without cause at any time upon written notice to PCA.

3. BACKUP AND REPLACEMENT COPIES

Customer may make one copy of the Software for back-up and archival purposes only, provided PCA's copyright and other proprietary rights notices are included on such copy.

4. PROTECTION AND SECURITY

- (a) Customer shall not provide or otherwise make available any of the Software or User Documentation in any form to any person other than employees of Customer with the need to know, without PCA's written permission.
- (b) All Software and User Documentation in Customer's possession including, without limitation, translations, compilations, back-up, and partial copies is the property of PCA. Upon termination of this Agreement for any reason, Customer shall immediately destroy all Software and User Documentation, including all media, and destroy any Software that has been copied onto other magnetic storage devices. Upon PCA's request, Customer shall certify its compliance in writing with the foregoing to PCA.
- (c) Customer shall take appropriate action, by instruction, agreement or otherwise, with any persons permitted access to the Software or User Documentation, to enable Customer to satisfy its obligations under this Agreement with respect to use, copying, protection, and security of the same.
- (d) If PCA prevails in an action against Customer for breach of the provisions of this Section 4, Customer shall pay the reasonable attorneys' fees, costs, and expenses incurred by PCA in connection with such action in addition to any award of damages.

5. CUSTOMER'S RESPONSIBILITIES

The essential purpose of this Agreement is to provide Customer with limited use rights to the Software and User Documentation. Customer accepts full responsibility for: (a) selection of the Software and User Documentation to satisfy Customer's business needs and achieve Customer's intended results; (b) the use, set-up and installation of the Software and User Documentation; (c) all results obtained from use of the Software and User Documentation; and (d) the selection, use of, and results obtained from any other software, programming equipment or services used with the Software or User Documentation.

6. LIMITED WARRANTIES

PCA and Dealer (if any) warrants to Customer that: (a) PCA and Dealer (if any) has title to the Software and User Documentation and/or the right to grant Customer the rights granted hereunder; (b) the Software and User Documentation provided hereunder is PCA's most current

production version thereof; and (c) the copy of the Software provided hereunder is an accurate reproduction of the original from which it was made.

7. LIMITATION OF REMEDY

- (a) **PCA AND DEALER (IF ANY) HAS NO LIABILITY UNDER THIS AGREEMENT. CUSTOMER'S EXCLUSIVE REMEDY FOR DAMAGES DUE TO PERFORMANCE OR NONPERFORMANCE OF ANY SOFTWARE OR USER DOCUMENTATION, PCA, DEALER (IF ANY), OR ANY OTHER CAUSE WHATSOEVER, AND REGARDLESS OF THE FORM OF ACTION, WHETHER IN CONTRACT OR IN TORT, INCLUDING NEGLIGENCE, SHALL BE LIMITED TO CUSTOMER STOPPING ALL USE OF THE SOFTWARE AND USER DOCUMENTATION AND RETURNING THE SAME TO PCA.**
- (b) **NEITHER PCA NOR DEALER (IF ANY) IS AN INSURER WITH REGARD TO THE PERFORMANCE OF THE SOFTWARE OR USER DOCUMENTATION. THE TERMS OF THIS AGREEMENT, INCLUDING, BUT NOT LIMITED TO, THE LIMITED WARRANTIES, AND THE LIMITATION OF LIABILITY AND REMEDY, ARE A REFLECTION OF THE RISKS ASSUMED BY THE PARTIES. IN ORDER TO OBTAIN THE SOFTWARE AND USER DOCUMENTATION FROM PCA OR DEALER (IF ANY), CUSTOMER HEREBY ASSUMES THE RISKS FOR (1) ALL LIABILITIES DISCLAIMED BY PCA AND DEALER (IF ANY) ON THE FACE HEREOF; AND (2) ALL ACTUAL OR ALLEGED DAMAGES IN CONNECTION WITH THE USE OF THE SOFTWARE AND USER DOCUMENTATION. THE ESSENTIAL PURPOSE OF THE LIMITED REMEDY PROVIDED CUSTOMER HEREUNDER IS TO ALLOCATE THE RISKS AS PROVIDED ABOVE.**

8. U.S. GOVERNMENT RESTRICTED RIGHTS

This commercial computer software and commercial computer software documentation were developed exclusively at private expense by Portland Cement Association, 5420 Old Orchard Road, Skokie, Illinois, 60077. U.S. Government rights to use, modify, release, reproduce, perform, display or disclose this computer software and computer software documentation are subject to the restrictions of DFARS 227.7202-1(a) (June 1995) and DFARS 227.7202-3(a) (June 1995), or the Restricted Rights provisions of FAR 52.227-14 (June 1987) and FAR 52.227-19 (June 1987), as applicable.

9. GENERAL

- (a) No action arising out of any claimed breach of this Agreement or transactions under this Agreement may be brought by Customer more than two years after the cause of such action has arisen.
- (b) Customer may not assign, sell, sublicense or otherwise transfer this Agreement, the license granted herein or the Software or User Documentation by operation of law or otherwise without the prior written consent of PCA. Any attempt to do any of the foregoing without PCA's consent is void.
- (c) Customer acknowledges that the Software, User Documentation and other proprietary information and materials of PCA are unique and that, if Customer breaches this Agreement, PCA may not have an adequate remedy at law and PCA may enforce its rights hereunder by an action for damages and/or injunctive or other equitable relief without the necessity of proving actual damage or posting a bond therefor.

- (D) THE RIGHTS AND OBLIGATIONS UNDER THIS AGREEMENT SHALL NOT BE GOVERNED BY THE UNITED NATIONS CONVENTION ON CONTRACTS FOR THE INTERNATIONAL SALE OF GOODS, THE APPLICATION OF WHICH IS EXPRESSLY EXCLUDED, BUT SUCH RIGHTS AND OBLIGATIONS SHALL INSTEAD BE GOVERNED BY THE LAWS OF THE STATE OF ILLINOIS, APPLICABLE TO CONTRACTS ENTERED INTO AND PERFORMED ENTIRELY WITHIN THE STATE OF ILLINOIS AND APPLICABLE FEDERAL (U.S.) LAWS. UCITA SHALL NOT APPLY TO THIS AGREEMENT.
- (E) THIS AGREEMENT SHALL BE TREATED AS THOUGH IT WERE EXECUTED IN THE COUNTY OF COOK, STATE OF ILLINOIS, AND WAS TO HAVE BEEN PERFORMED IN THE COUNTY OF COOK, STATE OF ILLINOIS. ANY ACTION RELATING TO THIS AGREEMENT SHALL BE INSTITUTED AND PROSECUTED IN A COURT LOCATED IN COOK COUNTY, ILLINOIS. CUSTOMER SPECIFICALLY CONSENTS TO EXTRATERRITORIAL SERVICE OF PROCESS.
- (f) Except as prohibited elsewhere in this Agreement, this Agreement shall be binding upon and inure to the benefit of the personal and legal representatives, permitted successors, and permitted assigns of the parties hereto.
- (g) All notices, demands, consents or requests that may be or are required to be given by any party to another party shall be in writing. All notices, demands, consents or requests given by the parties hereto shall be sent either by U.S. certified mail, postage prepaid or by an overnight international delivery service, addressed to the respective parties. Notices, demands, consents or requests served as set forth herein shall be deemed sufficiently served or given at the time of receipt thereof.
- (h) The various rights, options, elections, powers, and remedies of a party or parties to this Agreement shall be construed as cumulative and no one of them exclusive of any others or of any other legal or equitable remedy that said party or parties might otherwise have in the event of breach or default in the terms hereof. The exercise of one right or remedy by a party or parties shall not in any way impair its rights to any other right or remedy until all obligations imposed on a party or parties have been fully performed.
- (i) No waiver by Customer, PCA or Dealer (if any) of any breach, provision, or default by the other shall be deemed a waiver of any other breach, provision or default.
- (j) The parties hereto, and each of them, agree that the terms of this Agreement shall be given a neutral interpretation and any ambiguity or uncertainty herein should not be construed against any party hereto.
- (k) If any provision of this Agreement or portion thereof is held to be unenforceable or invalid by any court or competent jurisdiction, such decision shall not have the effect of invalidating or voiding the remainder of this Agreement, it being the intent and agreement of the parties that this Agreement shall be deemed amended by modifying such provision to the extent necessary to render it enforceable and valid while preserving its intent or, if such modification is not possible, by substituting therefor another provision that is enforceable and valid so as to materially effectuate the parties' intent.
- (l) Except as set forth herein, this Agreement may be modified or amended only by a written instrument signed by a duly authorized representative of PCA and Customer.

PORTLAND CEMENT ASSOCIATION SOFTWARE LICENSE AGREEMENT

BY CLICKING THE "I AGREE" BELOW, OR BY INSTALLING, COPYING, OR OTHERWISE USING THE SOFTWARE OR USER DOCUMENTATION, YOU AGREE TO BE BOUND BY THE TERMS OF THIS AGREEMENT, INCLUDING, BUT NOT LIMITED TO, THE WARRANTY DISCLAIMERS, LIMITATIONS OF LIABILITY AND TERMINATION PROVISIONS BELOW. IF YOU DO NOT AGREE TO THE TERMS OF THIS AGREEMENT, DO NOT INSTALL OR USE THE SOFTWARE OR USER DOCUMENTATION, EXIT THIS APPLICATION NOW AND RETURN THE SOFTWARE AND USER DOCUMENTATION TO PCA FOR A FULL REFUND WITHIN THIRTY DAYS AFTER YOUR RECEIPT OF THE SOFTWARE AND USER DOCUMENTATION.

PORTLAND CEMENT ASSOCIATION, 5420 OLD ORCHARD ROAD, SKOKIE, ILLINOIS 60077 (HEREAFTER PCA), GRANTS THE CUSTOMER A PERSONAL, NONEXCLUSIVE, LIMITED, NONTRANSFERABLE LICENSE TO USE THIS SOFTWARE AND USER DOCUMENTATION IN ACCORDANCE WITH THE TERMS AND CONDITIONS OF THIS AGREEMENT. SOFTWARE AND USER DOCUMENTATION IS SUPPLIED TO CUSTOMER EITHER BY PCA DIRECTLY OR THROUGH AN AUTHORIZED DEALER OF PCA (HEREAFTER DEALER).

WHILE PCA HAS TAKEN PRECAUTIONS TO ASSURE THE CORRECTNESS OF THE ANALYTICAL SOLUTION AND DESIGN TECHNIQUES USED IN THIS SOFTWARE, IT CANNOT AND DOES NOT GUARANTEE ITS PERFORMANCE, NOR CAN IT OR DOES IT BEAR ANY RESPONSIBILITY FOR DEFECTS OR FAILURES IN STRUCTURES IN CONNECTION WITH WHICH THIS SOFTWARE IS USED. DEALER (IF ANY) HAS NOT PARTICIPATED IN THE DESIGN OR DEVELOPMENT OF THIS SOFTWARE AND NEITHER GUARANTEES THE PERFORMANCE OF THE SOFTWARE NOR BEARS ANY RESPONSIBILITY FOR DEFECTS OR FAILURES IN STRUCTURES IN CONNECTION WITH WHICH THIS SOFTWARE IS USED.

PCA AND DEALER (IF ANY) EXPRESSLY DISCLAIM ANY WARRANTY THAT: (A) THE FUNCTIONS CONTAINED IN THE SOFTWARE WILL MEET THE REQUIREMENTS OF CUSTOMER OR OPERATE IN COMBINATIONS THAT MAY BE SELECTED FOR USE BY CUSTOMER; (B) THE OPERATION OF THE SOFTWARE WILL BE FREE OF ALL "BUGS" OR PROGRAM ERRORS; OR (C) THE SOFTWARE CONFORMS TO ANY PERFORMANCE SPECIFICATIONS. CUSTOMER ACKNOWLEDGES THAT PCA IS UNDER NO OBLIGATION TO PROVIDE ANY SUPPORT, UPDATES, BUG FIXES OR ERROR CORRECTIONS TO OR FOR THE SOFTWARE OR USER DOCUMENTATION.

THE LIMITED WARRANTIES IN SECTION 7 HEREOF ARE IN LIEU OF ALL OTHER WARRANTIES, EXPRESS OR IMPLIED, INCLUDING, BUT NOT LIMITED TO, ANY IMPLIED WARRANTIES OF NON-INFRINGEMENT, MERCHANTABILITY OR FITNESS FOR A PARTICULAR PURPOSE, EACH OF WHICH IS HEREBY DISCLAIMED. EXCEPT AS SET FORTH IN SECTION 7, THE SOFTWARE AND USER DOCUMENTATION ARE PROVIDED ON AN "AS-IS" BASIS.

IN NO EVENT SHALL PCA OR DEALER (IF ANY) BE LIABLE FOR: (A) LOSS OF PROFITS, INDIRECT, INCIDENTAL, SPECIAL, EXEMPLARY, PUNITIVE, CONSEQUENTIAL OR OTHER DAMAGES, EVEN IF PCA OR DEALER (IF ANY) HAS BEEN ADVISED OF THE POSSIBILITY OF SUCH DAMAGES; (B) ANY CLAIM AGAINST CUSTOMER BY ANY THIRD PARTY EXCEPT AS PROVIDED IN SECTION 8 ENTITLED "INFRINGEMENT"; OR (C) ANY DAMAGES CAUSED BY (1) DELAY IN DELIVERY OF THE SOFTWARE OR USER DOCUMENTATION UNDER THIS AGREEMENT; (2) THE PERFORMANCE OR NONPERFORMANCE OF THE SOFTWARE; (3) RESULTS FROM USE OF THE SOFTWARE OR USER DOCUMENTATION, INCLUDING, WITHOUT

LIMITATION, MISTAKES, ERRORS, INACCURACIES, FAILURES OR CUSTOMER'S INABILITY TO PROVIDE SERVICES TO THIRD PARTIES THROUGH USE OF THE SOFTWARE OR USER DOCUMENTATION; (4) CUSTOMER'S FAILURE TO PERFORM CUSTOMER'S RESPONSIBILITIES; (5) PCA NOT PROVIDING UPDATES, BUG FIXES OR CORRECTIONS TO OR FOR ANY OF THE SOFTWARE OR USER DOCUMENTATION; (6) LABOR, EXPENSE OR MATERIALS NECESSARY TO REPAIR DAMAGE TO THE SOFTWARE OR USER DOCUMENTATION CAUSED BY (a) ACCIDENT, (b) NEGLIGENCE OR ABUSE BY CUSTOMER, (c) ACTS OF THIRD PERSONS INCLUDING, BUT NOT LIMITED TO, INSTALLATION, REPAIR, MAINTENANCE OR OTHER CORRECTIVE WORK RELATED TO ANY EQUIPMENT BEING USED, (d) CAUSES EXTERNAL TO THE SOFTWARE SUCH AS POWER FLUCTUATION AND FAILURES, OR (e) FLOODS, WINDSTORMS OR OTHER ACTS OF GOD. MOREOVER, IN NO EVENT SHALL PCA BE LIABLE FOR WARRANTIES, GUARANTEES, REPRESENTATIONS OR ANY OTHER UNDERSTANDINGS BETWEEN CUSTOMER AND DEALER (IF ANY) RELATING TO THE SOFTWARE OR USER DOCUMENTATION.

THIS AGREEMENT CONSTITUTES THE ENTIRE AND EXCLUSIVE AGREEMENT BETWEEN CUSTOMER AND PCA AND DEALER (IF ANY) WITH RESPECT TO THE SOFTWARE AND USER DOCUMENTATION TO BE FURNISHED HEREUNDER. IT IS A FINAL EXPRESSION OF THAT AGREEMENT AND UNDERSTANDING. IT SUPERSEDES ALL PRIOR COMMUNICATIONS BETWEEN THE PARTIES (INCLUDING ANY EVALUATION LICENSE AND ALL ORAL AND WRITTEN PROPOSALS). ORAL STATEMENTS MADE BY PCA'S OR DEALER'S (IF ANY) REPRESENTATIVES ABOUT THE SOFTWARE OR USER DOCUMENTATION DO NOT CONSTITUTE REPRESENTATIONS OR WARRANTIES, SHALL NOT BE RELIED ON BY CUSTOMER, AND ARE NOT PART OF THIS AGREEMENT.

1. LICENSE RESTRICTIONS

- (a) Except as expressly provided in this Agreement or as otherwise authorized in writing by PCA, Customer has no right to: (1) use, print, copy, display, reverse assemble, reverse engineer, translate or decompile the Software or User Documentation in whole or in part; (2) disclose, publish, release, sublicense or transfer to another person any Software or User Documentation; (3) reproduce the Software or User Documentation for the use or benefit of anyone other than Customer; or (4) modify any Software or User Documentation. All rights to the Software and User Documentation not expressly granted to Customer hereunder are retained by PCA. All copyrights and other proprietary rights except as expressed elsewhere in the Software or User Documentation and legal title thereto shall remain in PCA. Customer may use the Software at only one designated workstation at Customer's site at any given time. Customer may not transmit the Software electronically to any other workstation, computer, node or terminal device whether via a local area network, a wide area network, telecommunications transmission, the Internet or other means now known or hereafter created without prior written permission by PCA.
- (B) **CUSTOMER ACKNOWLEDGES THAT THE REGISTRATION PROCESS FOR THE SOFTWARE RESULTS IN THE GENERATION OF A UNIQUE LICENSE KEY AND ACTIVATION CODE PAIR. ONCE THE LICENSE KEY AND ACTIVATION CODE ARE ENTERED DURING THE INSTALLATION PROCESS, THE SOFTWARE WILL ONLY WORK ON THE COMPUTER ON WHICH THE SOFTWARE IS INITIALLY INSTALLED. IF YOU NEED TO DEINSTALL THE SOFTWARE AND REINSTALL THE SOFTWARE ON A DIFFERENT COMPUTER, YOU MUST CONTACT PCA TO OBTAIN THE NECESSARY REINSTALLATION PROCEDURES.**

2. CHARGES AND PAYMENTS

All payments for the Software and User Documentation shall be made to either PCA or Dealer (if any), as appropriate.

3. TERM AND TERMINATION

- (a) This Agreement shall be in effect from the date Customer clicks the "I AGREE" below or installs, copies or otherwise uses the Software or User Documentation until it is terminated by Customer, by Dealer (if any) on behalf of Customer or PCA or by PCA as set forth herein.
- (b) This Agreement may be terminated by PCA without cause upon 30 days' written notice or immediately upon notice to Customer if Customer breaches this Agreement or fails to comply with any of its terms or conditions. This Agreement may be terminated by Customer without cause at any time upon written notice to PCA.

4. BACKUP AND REPLACEMENT COPIES

Customer may make one copy of the Software for back-up and archival purposes only, provided PCA's copyright and other proprietary rights notices are included on such copy.

5. PROTECTION AND SECURITY

- (a) Customer shall not provide or otherwise make available any of the Software or User Documentation in any form to any person other than employees of Customer with the need to know, without PCA's written permission.
- (b) All Software and User Documentation in Customer's possession including, without limitation, translations, compilations, back-up, and partial copies is the property of PCA. Upon termination of this Agreement for any reason, Customer shall immediately destroy all Software and User Documentation, including all media, and destroy any Software that has been copied onto other magnetic storage devices. Upon PCA's request, Customer shall certify its compliance in writing with the foregoing to PCA.
- (c) Customer shall take appropriate action, by instruction, agreement or otherwise, with any persons permitted access to the Software or User Documentation, to enable Customer to satisfy its obligations under this Agreement with respect to use, copying, protection, and security of the same.
- (d) If PCA prevails in an action against Customer for breach of the provisions of this Section 5, Customer shall pay the reasonable attorneys' fees, costs, and expenses incurred by PCA in connection with such action in addition to any award of damages.

6. CUSTOMER'S RESPONSIBILITIES

The essential purpose of this Agreement is to provide Customer with limited use rights to the Software and User Documentation. Customer accepts full responsibility for: (a) selection of the Software and User Documentation to satisfy Customer's business needs and achieve Customer's intended results; (b) the use, set-up and installation of the Software and User Documentation; (c) all results obtained from use of the Software and User Documentation; and (d) the selection, use of, and results obtained from any other software, programming equipment or services used with the Software or User Documentation.

7. LIMITED WARRANTIES

PCA and Dealer (if any) warrants to Customer that: (a) PCA and Dealer (if any) has title to the Software and User Documentation and/or the right to grant Customer the rights granted hereunder; (b) the Software and User Documentation provided hereunder is PCA's most current production version thereof; and (c) the copy of the Software provided hereunder is an accurate reproduction of the original from which it was made.

8. INFRINGEMENT

(a) PCA shall defend Customer against a claim that the Software or User Documentation furnished and used within the scope of the license granted hereunder infringes a U.S. patent or U.S. registered copyright of any third party that was issued or registered, as applicable, as of the date Customer clicked the "I AGREE" below or installed, copied or otherwise began using the Software or User Documentation, and PCA shall pay resulting costs, damages, and attorneys' fees finally awarded, subject to the limitation of liability set forth in Section 9 entitled "Limitation of Remedy," provided that:

1. Customer promptly notifies PCA in writing of the claim.
2. PCA has sole control of the defense and all related settlement negotiations.
3. If such claim has occurred or in PCA's opinion is likely to occur, Customer shall permit PCA at its sole option and expense either to procure for Customer the right to continue using the Software or User Documentation or to replace or modify the same so that it becomes noninfringing. If neither of the foregoing alternatives is reasonably available in PCA's sole judgment, Customer shall, on one month's written notice from PCA, return to PCA the Software and User Documentation and all copies thereof.

(b) PCA shall have no obligation to defend Customer or to pay costs, damages or attorneys' fees for any claim based upon (1) use of other than a current unaltered release of the Software or User Documentation, or (2) the combination, operation or use of any Software or User Documentation furnished hereunder with any other software, documentation or data if such infringement would have been avoided but for the combination, operation or use of the Software or User Documentation with other software, documentation or data.

(c) The foregoing states the entire obligation of PCA and Customer's sole remedy with respect to infringement matters relating to the Software and User Documentation.

9. LIMITATION OF REMEDY

- (a) PCA'S AND DEALER'S (IF ANY) ENTIRE LIABILITY AND CUSTOMER'S EXCLUSIVE REMEDY FOR DAMAGES DUE TO PERFORMANCE OR NONPERFORMANCE OF ANY SOFTWARE OR USER DOCUMENTATION, PCA, DEALER (IF ANY), OR ANY OTHER CAUSE WHATSOEVER, AND REGARDLESS OF THE FORM OF ACTION, WHETHER IN CONTRACT OR IN TORT, INCLUDING NEGLIGENCE, SHALL BE LIMITED TO THE AMOUNT PAID TO PCA OR DEALER (IF ANY) FOR THE SOFTWARE AND USER DOCUMENTATION.
- (b) NEITHER PCA NOR DEALER (IF ANY) IS AN INSURER WITH REGARD TO THE PERFORMANCE OF THE SOFTWARE OR USER DOCUMENTATION. THE TERMS OF THIS AGREEMENT, INCLUDING, BUT NOT LIMITED TO, THE LIMITED WARRANTIES, AND THE LIMITATION OF LIABILITY AND REMEDY, ARE A REFLECTION OF THE RISKS ASSUMED BY THE PARTIES. IN ORDER TO OBTAIN THE SOFTWARE AND USER DOCUMENTATION FROM PCA OR DEALER (IF ANY), CUSTOMER HEREBY ASSUMES THE RISKS FOR (1) ALL LIABILITIES DISCLAIMED BY PCA AND DEALER (IF ANY) ON THE FACE HEREOF; AND (2) ALL ACTUAL OR

ALLEGED DAMAGES IN EXCESS OF THE AMOUNT OF THE LIMITED REMEDY PROVIDED HEREUNDER. THE ESSENTIAL PURPOSE OF THE LIMITED REMEDY PROVIDED CUSTOMER HEREUNDER IS TO ALLOCATE THE RISKS AS PROVIDED ABOVE.

10. U.S. GOVERNMENT RESTRICTED RIGHTS

This commercial computer software and commercial computer software documentation were developed exclusively at private expense by Portland Cement Association, 5420 Old Orchard Road, Skokie, Illinois 60077. U.S. Government rights to use, modify, release, reproduce, perform, display or disclose this computer software and computer software documentation are subject to the restrictions of DFARS 227.7202-1(a) (June 1995) and DFARS 227.7202-3(a) (June 1995), or the Restricted Rights provisions of FAR 52.227-14 (June 1987) and FAR 52.227-19 (June 1987), as applicable.

II. GENERAL

- (a) No action arising out of any claimed breach of this Agreement or transactions under this Agreement may be brought by Customer more than two years after the cause of such action has arisen.
- (b) Customer may not assign, sell, sublicense or otherwise transfer this Agreement, the license granted herein or the Software or User Documentation by operation of law or otherwise without the prior written consent of PCA. Any attempt to do any of the foregoing without PCA's consent is void.
- (c) Customer acknowledges that the Software, User Documentation and other proprietary information and materials of PCA are unique and that, if Customer breaches this Agreement, PCA may not have an adequate remedy at law and PCA may enforce its rights hereunder by an action for damages and/or injunctive or other equitable relief without the necessity of proving actual damage or posting a bond therefor.
- (D) THE RIGHTS AND OBLIGATIONS UNDER THIS AGREEMENT SHALL NOT BE GOVERNED BY THE UNITED NATIONS CONVENTION ON CONTRACTS FOR THE INTERNATIONAL SALE OF GOODS, THE APPLICATION OF WHICH IS EXPRESSLY EXCLUDED, BUT SUCH RIGHTS AND OBLIGATIONS SHALL INSTEAD BE GOVERNED BY THE LAWS OF THE STATE OF ILLINOIS, APPLICABLE TO CONTRACTS ENTERED INTO AND PERFORMED ENTIRELY WITHIN THE STATE OF ILLINOIS AND APPLICABLE FEDERAL (U.S.) LAWS. UCITA SHALL NOT APPLY TO THIS AGREEMENT.
- (E) THIS AGREEMENT SHALL BE TREATED AS THOUGH IT WERE EXECUTED IN THE COUNTY OF COOK, STATE OF ILLINOIS, AND WAS TO HAVE BEEN PERFORMED IN THE COUNTY OF COOK, STATE OF ILLINOIS. ANY ACTION RELATING TO THIS AGREEMENT SHALL BE INSTITUTED AND PROSECUTED IN A COURT LOCATED IN COOK COUNTY, ILLINOIS. CUSTOMER SPECIFICALLY CONSENTS TO EXTRATERRITORIAL SERVICE OF PROCESS.
- (f) Except as prohibited elsewhere in this Agreement, this Agreement shall be binding upon and inure to the benefit of the personal and legal representatives, permitted successors, and permitted assigns of the parties hereto.



- (g) All notices, demands, consents or requests that may be or are required to be given by any party to another party shall be in writing. All notices, demands, consents or requests given by the parties hereto shall be sent either by U.S. certified mail, postage prepaid or by an overnight international delivery service, addressed to the respective parties. Notices, demands, consents or requests served as set forth herein shall be deemed sufficiently served or given at the time of receipt thereof.
- (h) The various rights, options, elections, powers, and remedies of a party or parties to this Agreement shall be construed as cumulative and no one of them exclusive of any others or of any other legal or equitable remedy that said party or parties might otherwise have in the event of breach or default in the terms hereof. The exercise of one right or remedy by a party or parties shall not in any way impair its rights to any other right or remedy until all obligations imposed on a party or parties have been fully performed.
- (i) No waiver by Customer, PCA or Dealer (if any) of any breach, provision, or default by the other shall be deemed a waiver of any other breach, provision or default.
- (j) The parties hereto, and each of them, agree that the terms of this Agreement shall be given a neutral interpretation and any ambiguity or uncertainty herein should not be construed against any party hereto.
- (k) If any provision of this Agreement or portion thereof is held to be unenforceable or invalid by any court or competent jurisdiction, such decision shall not have the effect of invalidating or voiding the remainder of this Agreement, it being the intent and agreement of the parties that this Agreement shall be deemed amended by modifying such provision to the extent necessary to render it enforceable and valid while preserving its intent or, if such modification is not possible, by substituting therefor another provision that is enforceable and valid so as to materially effectuate the parties' intent.

Except as set forth herein, this Agreement may be modified or amended only by a written instrument signed by a duly authorized representative of PCA and Customer.

Chapter 1

Introduction

pcaSlab is a computer program for the analysis and design of reinforced concrete beams and slab systems. Two-way slab systems are analyzed using the Equivalent Frame Method. Beams and frames of up to 22 spans can be analyzed and designed. In addition to the design option pcaSlab has the capability of investigating existing beams and slab systems. pcaSlab includes such features as punching shear check and cracked-section or gross-section deflections. For beams, moment redistribution as well as combined shear and torsion design are available. Material quantity take-offs are computed. In addition to the required area of reinforcing steel at the critical sections, pcaSlab provides a complete bar schedule that includes number of bars and bar sizes and lengths. pcaSlab checks all applicable provisions of the relevant code.

pcaBeam is a limited version of pcaSlab. It includes all elements that apply to beams and one-way slab systems. Topics describing these elements are denoted with  icon because they are included in both pcaSlab and pcaBeam. Two-way slab systems are available in pcaSlab only and topics related to two-way slab systems are denoted with  icon.

Program Features



- ACI 318-02, ACI 318-99 and CSA A23.3-94
- English and SI units
- Beams/one-way slab and two-way slab systems design and investigation
- Flexure and shear design and investigation
- Torsion design and investigation for beams/one-way slab systems
- Moment redistribution for beams/one-way slab systems
- Mixed slab system types (pcaSlab only)
- Auto-input feature that walks you through the input process

- Checking of data as they are input
- Graphical display of geometry and loads as they are input
- Print preview of graphical screen
- User-controlled screen color settings
- Ability to save defaults and settings for future input sessions
- Customizable results report
- Import input data from ADOSS v6.0x/7.0x and PCA-Beam v1.0x
- Online help

Program Capacity

- 21 supports (22 spans including left and right cantilevers)
- 6 load cases
- 20 load combinations
- 999 partial dead loads per case
- 999 partial live loads per case
- 2 top bar layers (Design mode)
- 2 bottom bar layers (Design mode)
- 15 bar sets per span

System Requirements

Operating systems

- Windows 98 SE
- Windows ME
- Windows NT4
- Windows 2000
- Windows XP

Minimum Requirements

- 100 MHz processor
- 32 MB of RAM memory
- 50 MB of free hard disk space for program installation

Recommended Options

- Most recent OS service pack installed

Terms

The following terms are used throughout this manual. A brief explanation is given to help familiarize you with them.

Windows	refers to the Microsoft Windows environment version 98 or higher.
[]	indicates metric equivalent
Click on	means to position the cursor on top of a designated item or location and press and release the left-mouse button (unless instructed to use the right-mouse button).
Double-click on	means to position the cursor on top of a designated item or location and press and release the left-mouse button twice in quick succession.
Marquee select	means to depress the mouse button and continue to hold it down while moving the mouse. As you drag the mouse, a rectangle (known as a marquee) follows the cursor. Release the mouse button and the area inside the marquee is selected.

Conventions

Various styles of text and layout have been used in this manual to help differentiate between different kinds of information. The styles and layout are explained below...



placed in a topic header means that the topic applies to both pcaSlab and pcaBeam



placed in a topic header means that the topic applies to pcaSlab only

Italic

indicates a glossary item, or emphasizes a given word or phrase.

Bold

All bold typeface makes reference to either a menu or a menu item command such as **File** or **Save**, or a tab such as **General Information** or **Columns**

Mono-space

indicates something you should enter with the keyboard. For example type "c:*.txt".

KEY + KEY

indicates a key combination. The plus sign indicates that you should press and hold the first key while pressing the second key, then release both keys. For example, "ALT + F" indicates that you should press the "ALT" key and hold it while you press the "F" key. Then release both keys.

SMALL CAPS

Indicates the name of an object such as a dialog box or a dialog box component. For example, the OPEN dialog box or the CANCEL or MODIFY buttons.

Installing pcaSlab/pcaBeam

In the installation procedure described below, pcaSlab is used as an example. Installation steps for pcaBeam program are identical

1. If you have the installation disk please insert it into the CD drive and proceed to step 2. If you do not have the installation disk but downloaded the installation file from our website, please run the file and proceed to step 11.
2. If the auto-run functionality of Windows is enabled on your computer (which is the default setting) and a web browser (Internet Explorer, Netscape, etc.) is installed, the start page (Figure 1-1) is shown automatically. If the start page does not show up automatically, please go to step 7.

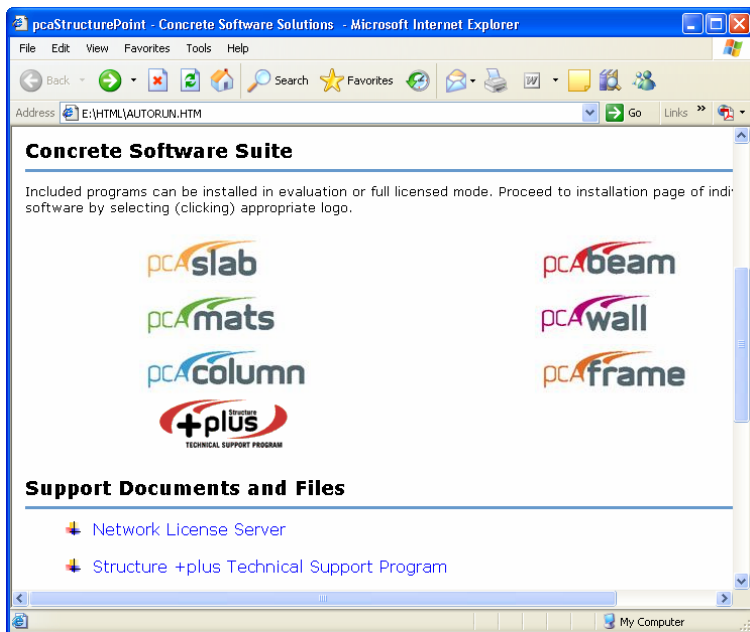

Figure 1-1 Start Page

3. If you are going to evaluate PCA software, please click the **Evaluation Software License Agreement** link and read through the agreement carefully. If you are going to use a commercial copy of PCA software, please click the **Software License Agreement** link and read through the agreement carefully.

- Click pcaSlab logo to start the installation. A second page will be shown as in Figure 1-2.

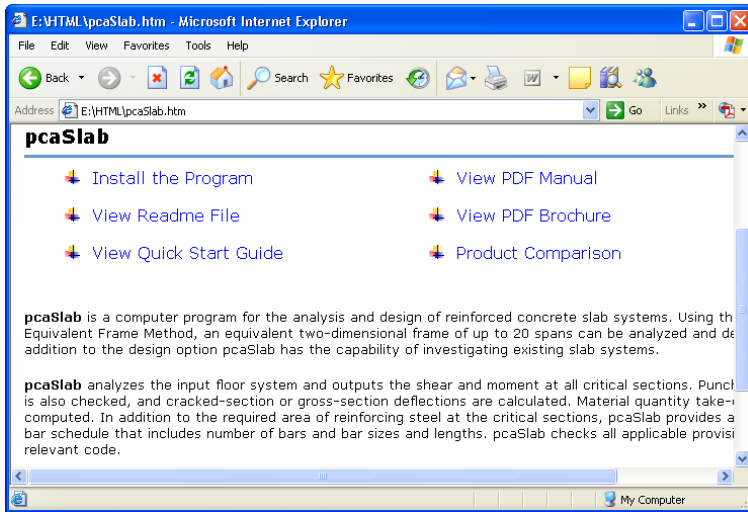

Figure 1-2. Second Installation Page

- Click the **Install the program**, then a dialog box will be shown as Figure 1 3.

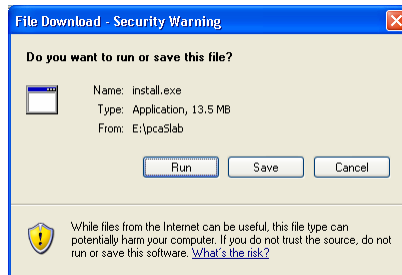

Figure 1-3 Click Open to Continue

- To continue, click the RUN button as shown in Figure 1-3. Press YES or RUN button if you see any security warning messages.
- If the start page doesn't show up automatically, open the Windows Explorer. In Windows 95, 98, ME, NT, 2000 use **Start/Programs/Accessories/Windows Explorer**. In Windows XP go to **Start/All Programs/Accessories/**

Windows Explorer. You may also start the Windows Explorer by pressing the keyboard shortcut WIN+E. A window similar to Figure 1-4 appears.

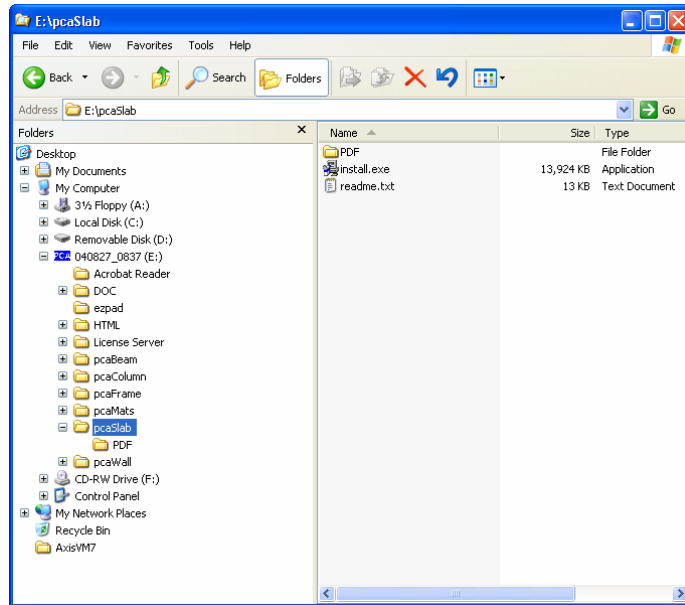

Figure 1-4 Windows Explorer

8. Select the CD drive from the left pane of Windows Explorer (e.g. E drive as in Figure 1-4).
9. Select the pcaSlab folder from the left pane. The contents of this folder are shown in the right pane.
10. Double click the install.exe in the right pane of the Windows Explorer.



Figure 1-5 Beginning of the installation

11. The installation process starts by displaying the following window (Figure 1-5). Please read all the information. Then press the NEXT button. This will continue the installation process by installing license manager, an evaluation license, and the application software.
12. The first step of the application installation process is to review the software license agreement as shown in Figure 1-6. Please read all the information carefully. Press the I AGREE button to confirm that you have read and agreed with it. This will continue the installation. If you do not agree with the license agreement press the I DO NOT AGREE button. This will stop the installation.

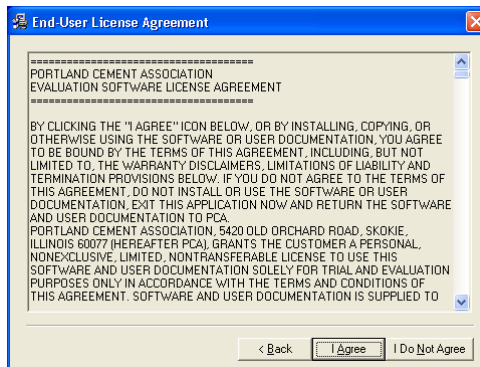

Figure 1-6 License agreement

- If you continue the installation then please read the latest information of the software included in the readme file (Figure 1-3). Having read all the information press the NEXT button.

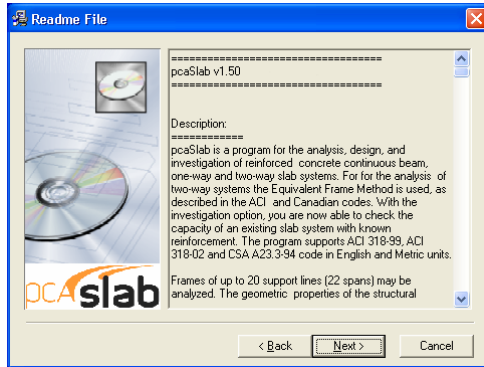

Figure 1-7 Readme file

- In the next step please provide the user's name and company. Press NEXT when you are ready to proceed.

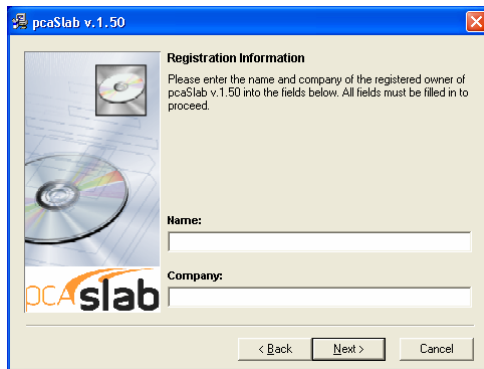

Figure 1-8 Registration information

- The next setup is to decide the directory where pcaSlab is to be installed as shown in Figure 1-9. The default one is C:\Program Files\PCA\pcaSlab. You may press the BROWSE button to locate the directory. If the directory does not exist, the setup program will create it. Press the NEXT button to go to the next step.

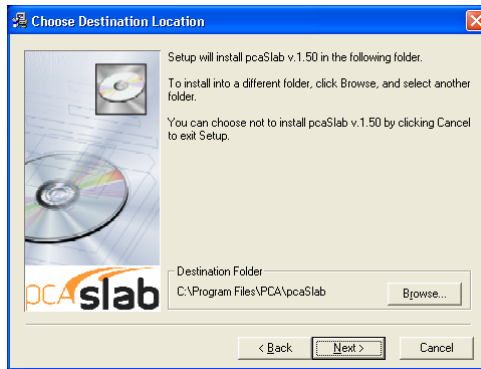

Figure 1-9 Choose Destination Location

16. The next step is to enter the group name as shown in Figure 1-10. Windows will use this name in the **Start/Programs** menu. Press the NEXT button to go to the next step.

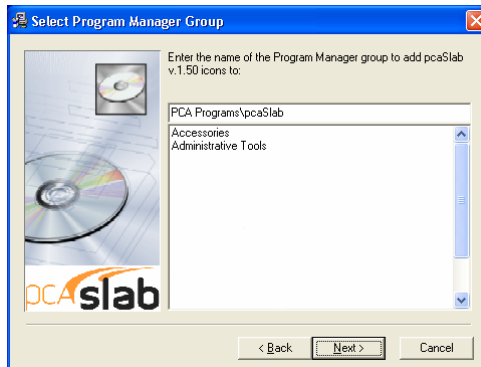

Figure 1-10 Select Program Manager Group

17. After all the previous steps are completed, press the NEXT button as shown in Figure 1-11 to start the installation.

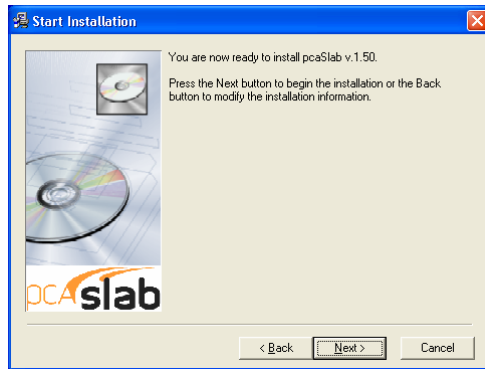

Figure 1-11 Start Installation

18. During the installation a window as in Fig. 1-12 shows the progress as files are copied to your hard drive.

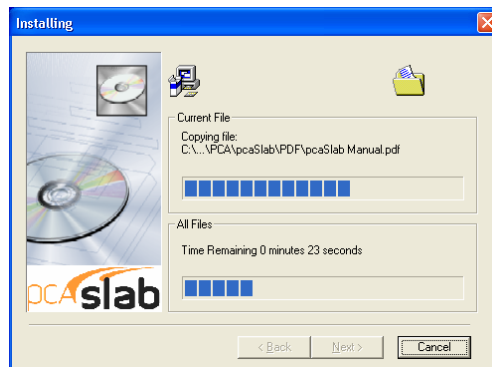

Figure 1-12 Installation progress

19. After the installation is completed, a dialog box similar to Figure 1-13 is shown. Press the FINISH button to finish the installation.

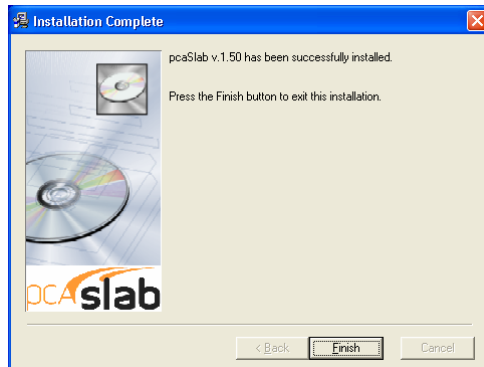

Figure 1-13 Installation Complete

Purchasing and Licensing Process

The following information is for stand-alone license only. Please refer to the *License Server Quick Start Guide* in the License Server directory on CD regarding the procedures to install networking license.

Licensing Model

By default, each pcaStructurePoint software application comes in an Evaluation mode. This means that initially our products can be used for a limited time of 15 days. If the user decides to purchase the software license, and completes the purchase, pcaStructurePoint will provide a License Code. By entering this code, user will activate the software license. Once the software license is activated the application will no longer have restrictions limiting the time of operation.

Evaluation Mode

This is the default mode of the license. In this licensing scheme, users are granted limited rights to use our full-featured software. The only visible difference between the evaluation version and the licensed version is an additional start-up dialog box as shown in Figure 1-14. It gives a choice of buying the software, entering the activation code or running the application in the evaluation mode by pressing the EVALUATE button. Evaluation mode is available for a limited time only. By default, pcaStructurePoint software applications come with 15 days. That means, from the day of installation, a user can evaluate the software for the next 15 days. After this time, user will either obtain a License, or uninstall the application.

Note: Any tampering with system clock or evaluation license file will render the software useless.

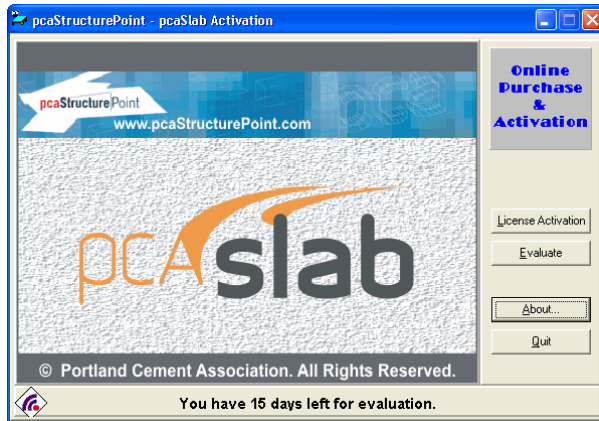

Figure 1-14 Start-up dialog box

How to Purchase

You may purchase the license on-line at www.pcaStructurePoint.com or by calling our Sales Team at 847-972-9042. To buy on-line you may press BUY NOW button, which will run your default web browser and open the product web page where you will be able to complete the transaction.

License Activation

After the purchase is completed, pcaStructurePoint will generate a unique Activation Code based on the product ID and the locking code, which is derived from the unique hardware-id of the user's computer. Each License is associated with the particular PC in which user has installed the pcaStructurePoint software. This implies that the activation-code will not work on any other PC. You can transfer the license to another PC by contacting pcaStructurePoint for the transfer procedures.

To activate the license press the LICENSE ACTIVATION button in the start-up dialog box. This will bring a window as in Figure 1-15, which shows three license activation methods.

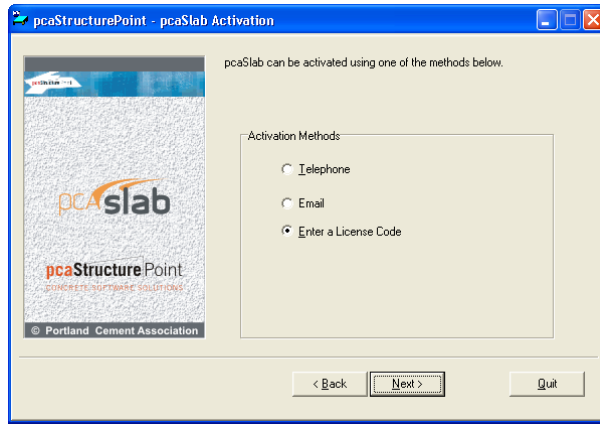

Figure 1-15 License activation methods

If you have already received the license code you may choose ENTER LICENSE CODE and then press the NEXT button. A window (Figure 1-16) will pop up where you will be able to type in the license code. However, in order to avoid mistyping we advise to use copy and paste feature instead of typing the code.

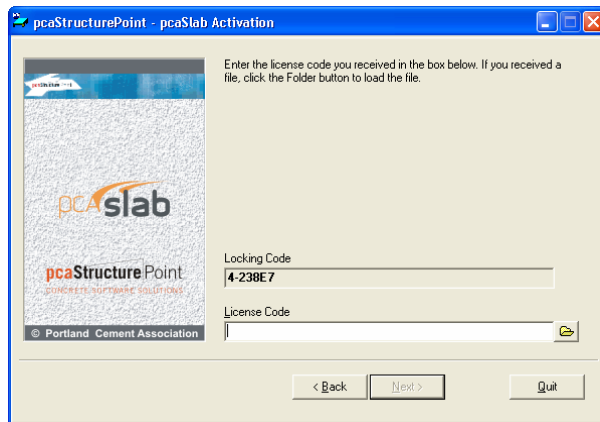



Figure 1-16 Enter license code

The license code can also be extracted from a file. To do that press the BROWSE button  and open the file in which the license code is stored using the open window (Figure 1-17).

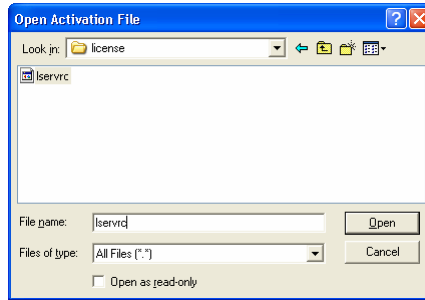

Figure 1-17 Open activation file

If the entered code is correct the license will be activated and window as in Figure 1-18 will show. When you press the FINISH button the license activation will be completed.

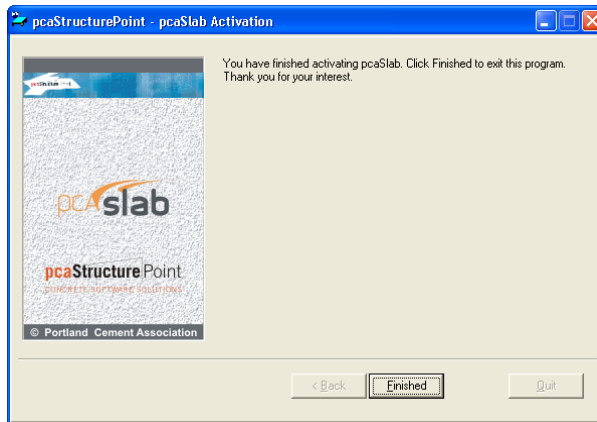

Figure 1-18 Activation completion

If you do not have the license code you may chose either TELEPHONE or E-MAIL method, whichever is more convenient for you. Please note that for E-MAIL method you need to have the Internet connection and a default mailer configured in your system.

Activation by Phone

If the telephone method was chosen to activate the license the following screen appears (Figure 1-19). It shows the product ID and the Locking Code.

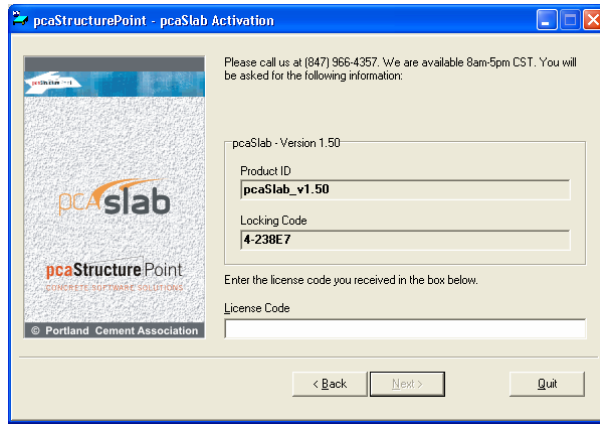

Figure 1-19 Activation by phone

This information is needed when you make a phone call at 847-966-4357 (HELP) to obtain the license. You will be asked to provide information about yourself in order to verify that you have purchased the license.

Activation by E-mail

If the e-mail method was chosen to activate the license a screen (Figure 1-20) will show prompting you to provide information about yourself. When you type in all the information press the SEND E-MAIL button and it will be automatically e-mailed to us together with the product ID and the Locking Code. After the information is verified the license code will be generated and e-mailed back to you.

Please fill out the fields below and click 'Send E-mail'. The * denotes fields that are required to complete your activation request.

Company

*Name

*Street Address

*City State/Province Zip/Postal Code

*Country United States E-mail Address

*Phone Number Fax Number

< Back Send E-mail Quit

Figure 1-20 Activation by e-mail

After you receive it you may enter it by pressing the LICENSE ACTIVATION button in the start up dialog box (Figure 1-14) and choosing ENTER LICENSE CODE option. If the entered code is correct, the license will be activated and window as in Figure 1-18 will show. When you press the FINISH button the license activation will be completed.

If you experience any problems registering or licensing the software, contact our Technical Support team.

Running the Program

To execute pcaSlab select the START button located in your Windows taskbar. In Windows 98, ME, NT, 2000 follow the path of **Programs/PCA Programs/pcaSlab/**. In Windows XP follow the path of **All Programs/PCA Programs/pcaSlab/**. Then select the "pcaSlab" icon.

Removing the Program

To remove the program from your computer:

1. Click START button located in your Windows taskbar.
2. In Windows 98, ME, NT, 2000, select Programs/PCA Programs/pcaSlab/; In Windows XP, select All Programs/PCA Programs/pcaSlab/.
3. Select Uninstall **pcaSlab**.
4. Follow the steps shown by the un-installation wizard to remove the program.

Chapter 2

Method of Solution

The user should be aware of the assumptions made by the program during the design stage. These include details regarding loading, strip widths, reinforcement selection, deflection computations, material quantities, etc.

Geometric checks

pcaSlab|pcaBeam

The pcaSlab program provides geometric checks to avoid an analysis with an inconsistent system. The dimensions of the slabs, drops and column capitals are checked and modified to produce a legitimate system.

If the slab cantilever length is less than one-half the column dimension in the direction of analysis, c_1 , or less than the lateral extension of the transverse beam into the cantilever, the cantilever length will be increased to the larger of these two lengths. If the slab width is less than one-half the column dimension transverse to the direction of analysis, c_2 , or less than one-half the longitudinal beam width, the slab width will be increased to the larger of these two widths.

If the drop panel lengths extend beyond the end of the slab cantilevers, the drop panel lengths will be reduced so that they extend only to the cantilever tip. The drop panel edges will be shifted forward or backward in the transverse direction when the slab strip width on either side of the column is less than one-half the drop panel width.

If a column capital contains a depth/extension ratio less than 1, the extension will be limited to the capital depth. The upper limit for the depth/extension ratio is 50. If, by drawing lines extending the column capital through the drop or beam to the underside of the slab, the column capital extension falls outside the edge of the drop or beam at the slab soffit, the extension will be modified such that these lines extend only up to the edge of the drop or beam at the slab soffit (Figure 2-1). The modified column capital dimensions will be used when computing column stiffness.

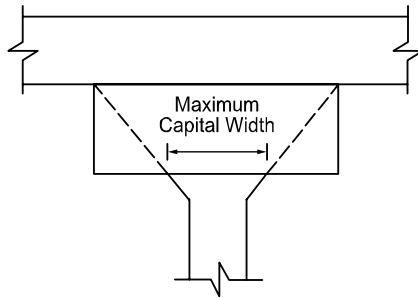

Figure 2-1 Maximum capital width

Code Checks

Prior to an analysis, pcaSlab checks that the input values for the drop panel dimensions, column capital dimensions, T-beam flange widths, waffle slab rib dimensions and slab and beam depths meet the applicable code values.

Drop Panel Dimensions

A valid drop must extend in each direction at least one-sixth the center-to-center span length in that direction (Figure 2-2) and have a drop depth below the slab of at least one-quarter the input slab depth. ACI slabs that contain valid drops are allowed a 10% decrease in minimum slab depth¹. The drop depth of an invalid drop will not be used in the calculation of the depth used to reduce the amount of reinforcement required at a column², and will not be used in the calculation of moment of inertia for deflection computations.

If the valid drop depth is greater than one-quarter the distance from the edge of the drop panel to the face of the column (x) the excess depth exceeding $\frac{1}{4}x$ will not be considered in the calculation of the effective depth used to reduce the amount of reinforcement required at a column (Figure 2-3)³.

¹ ACI 318-99, 9.5.3.2; ACI 318-02, 9.5.3.2

² ACI 318-99, 13.3.7; ACI 318-02, 13.3.7

³ ACI 318-99, 13.3.7.3; ACI 318-02, 13.3.7.3; CSA A23.3-94, 13.11.6

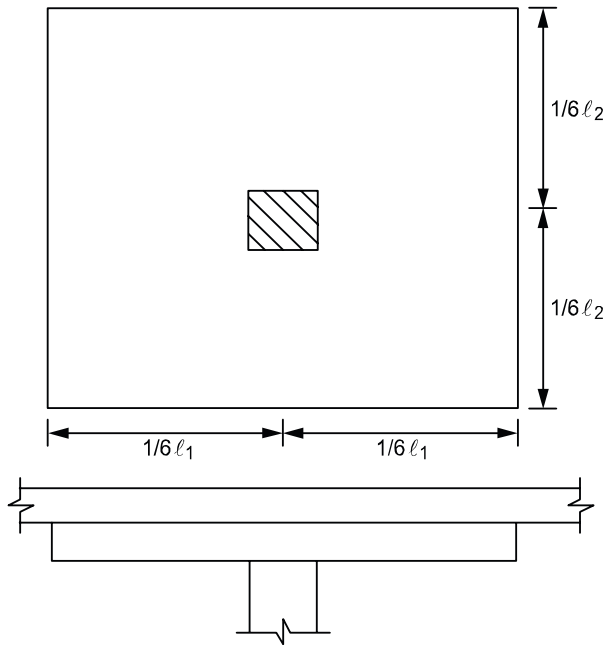

Figure 2-2 Valid drop dimensions

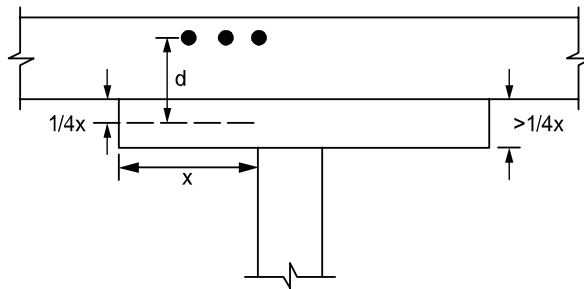

Figure 2-3 Excess drop depth

The input drop dimensions will be used for self-weight computations, when computing slab stiffness and to determine moments and shears when computing punching shear around a column.

Minimum Slab Thickness

For ACI 318 Code, the minimum thickness of slabs with or without interior beams spanning between supports and having a ratio of long to short span not exceeding 2 is⁴:

$$h = \frac{l_n \left(0.8 + \frac{f_y}{200,000} \right)}{36 + 5\beta(\alpha_m - 0.2)}, \quad 0.2 < \alpha_m \leq 2.0 \quad \text{Eq. 2-1}$$

but not less than

$$h = \frac{l_n \left(0.8 + \frac{f_y}{200,000} \right)}{36 + 9\beta}, \quad \alpha_m > 2.0. \quad \text{Eq. 2-2}$$

For CSA A23.3-94

$$h_s \geq \frac{l_n \left(0.6 + \frac{f_y}{1000} \right)}{30 + 4\beta\alpha_m}, \quad \alpha_m \text{ taken } \leq 2.0, \quad \text{Eq. 2-3}$$

where

- l_n = clear span in the direction of analysis,
- β = ratio of the clear spans in long to short direction,
- f_y = yield stress of reinforcing steel,
- α_m = average value of α , the ratio of flexural stiffness of a beam section to the flexural stiffness of a width of slab bounded laterally by centerlines of adjacent panels on either side of the beam, for all beams supporting the edges of a slab panel.

For the design of ACI slabs without beams ($\alpha_m \leq 0.2$) spanning between supports the minimum thickness shall conform to ACI 318 Table 9.5(c). For flat slabs that contain valid drops, Table 9.5(c) reduces the minimum thickness by approximately 10%.⁵ (See Figure 2-2).

The minimum thickness in a span that contains a discontinuous edge will be increased by 10%, if the edge beam provided has a stiffness ratio, α , of less than

⁴ ACI 318-99, 9.5.3.3; ACI 318-02, 9.5.3.3; CSA A23.3-94, 13.3.5

⁵ ACI 318-99, 9.5.3.2; ACI 318-02, 9.5.3.2

0.80.⁶ The first and last spans are considered to contain a discontinuous edge as well as a span that contains an exterior edge.

For the CSA Standard the minimum thickness is:

- for flat plates and slabs with column capitals

$$h_s > \frac{l_n \left(0.6 + \frac{f_y}{1000} \right)}{30}, \quad \text{Eq. 2-4}$$

- for slabs with drop panels

$$h_s \geq \frac{l_n \left(0.6 + \frac{f_y}{1000} \right)}{30 \left[1 + \left(\frac{2x_d}{l_n} \right) \left(\frac{h_d - h_s}{h_s} \right) \right]}, \quad \text{Eq. 2-5}$$

where $2x_d/l_n$ is the smaller of the values determined in the two directions, x_d shall not be taken greater than $l_n/4$, and $(h_d - h_s)$ shall not be greater than h_s .

For flat plate systems, the minimum allowable thickness can in no case be less than 5.0 in. For two-way flat slab systems with drops, described above, the minimum allowable thickness can in no case be less than 4.0 in.⁷ For supported slab systems supported by beams with an α_m greater than or equal to 2.0, the minimum allowable thickness can in no case be less than 3.5 in.⁸

A message will be printed with the output showing the required slab depth for any span where the depth does not meet or exceed code requirements.

Minimum Thickness for Waffle Slab Systems

The minimum slab thickness allowed for waffle slabs is one-twelfth the clear rib spacing, or 2 in.⁹

A message will be printed with the output showing the required slab depth for the system if the depth does not meet or exceed code requirements.

⁶ ACI 318-99, 9.5.3.3 (d); ACI 318-02, 9.5.3.3 (d)

⁷ ACI 318-99, 9.5.3.2; ACI 318-02, 9.5.3.2

⁸ ACI 318-99, 9.5.3.3; ACI 318-02, 9.5.3.3

⁹ ACI 318-99, 8.11.6.1; ACI 318-02, 8.11.6.1

Waffle Rib Dimensions

Waffle slab rib dimensions will be considered valid if the rib width is at least 4 in. (or 100 mm), the depth is no more than 3-1/2 times the rib width, and the clear spacing between ribs does not exceed 30 in. (or 750 mm) (Figure 2-4). When valid ribs exist, the ACI code permits the nominal concrete shear strength, V_c , to be increased by 10%.¹⁰

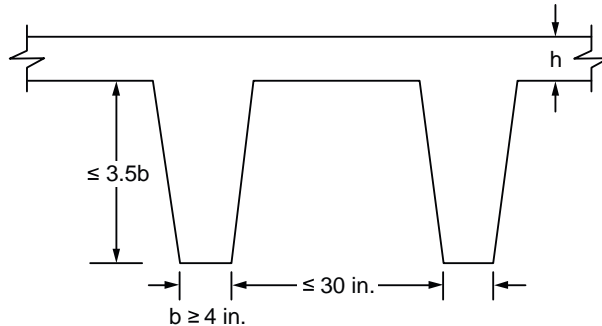

Figure 2-4 Valid rib dimensions

Special Considerations for Waffle Slabs

For the purposes of analysis and design, pcaSlab replaces the waffle with solid slabs of equivalent moment of inertia, weight, and punching shear resistance.

The equivalent thickness based on system weight is used to compute the system self-weight. This thickness, h_w , is given by:

$$h_w = \frac{V_{\text{mod}}}{A_{\text{mod}}}, \quad \text{Eq. 2-6}$$

where:

V_{mod} = the volume of one waffle module,
 A_{mod} = the plan area of one waffle module.

The equivalent thickness based on moment of inertia is used to compute slab stiffness. The ribs spanning in the transverse direction are not considered in the stiffness computations. This thickness, h_{MI} , is given by:

¹⁰ ACI 318-99, 8.11.8; ACI 318-02, 8.11.8

$$h_{MI} = \left(\frac{12I_{rib}}{b_{rib}} \right)^{\frac{1}{3}}, \quad \text{Eq. 2-7}$$

where:

- I_{rib} = moment of inertia of one waffle section between centerlines of ribs.
 b_{rib} = the center-to-center distance of two ribs (clear rib spacing plus rib width).

The drop depth for waffle slab systems is set equal to the rib depth. The equivalent drop depth based on moment of inertia, d_{MI} , is given by:

$$d_{MI} = h_{MI} + h_{rib} \quad \text{Eq. 2-8}$$

where:

- h_{rib} = rib depth below slab,
 h_{MI} = equivalent slab thickness based on moment of inertia.

A drop depth entered for a waffle slab system other than 0 will be added to d_{MV} , thus extending below the ribs.

The equivalent thickness based on shear area is used to compute the area of concrete section resisting shear transfer, A_c around the drop. The equivalent slab thickness, h_v , used to compute A_c , is given by:

$$h_v = \frac{A_{rib}}{b_{rib}} + d_{reinf} \quad \text{Eq. 2-9}$$

where:

- A_{rib} = the entire rib area below the slab plus the slab thickness minus the distance to the reinforcement centroid, d_{reinf} , within the rib width, i.e., the slab depth between the ribs is not considered as contributing to shear resistance,
 b_{rib} = the center-to-center distance of two ribs (clear rib spacing plus rib width),
 d_{reinf} = the distance to reinforcement centroid from the slab top at the support.

Material Properties

By entering the concrete density and compressive strength of the members, default values for the other concrete properties are determined. The slab, column, and beam members may have different concrete properties.

The density of concrete is used to determine the type of concrete, modulus of elasticity, and self-weight.

For the ACI 318 code, the concrete type is used to determine the default value of f_{ct} , the average split tensile strength of concrete. The concrete type is determined in accordance with Table 2-1.

Note: The CSA Standard does not use f_{ct} .

Density (w)		Type
Pcf	kg/m3	
$w \geq 130$	$w \geq 2000$	Normal
$105 < w < 130$	$1700 < w < 2000$	Sand-Lightweight
$w \leq 105$	$w \leq 1700$	All-Lightweight

Table 2-1 Default Concrete Types

Once the compressive strength of concrete f'_c is input, various parameters are set to their default values.

The modulus of elasticity is computed as:¹¹

$$E_c = 33w^{1.5}\sqrt{f'_c}, \quad \text{Eq. 2-10}$$

where:

w = is the density of the concrete.

For CSA A23.3 standard

$$E_c = \left(3300\sqrt{f'_c} + 6900 \right) \left(\frac{\gamma}{2300} \right)^{1.5} \quad \text{Eq. 2-11}$$

where:

¹¹ ACI 318-99, 8.5.1; ACI 318-02, 8.5.1; CSA A23.3-94, 8.6.2.2

γ = the unit weight of concrete.

The square root of f'_c is limited to 100 psi for the computation of shear strength provided by concrete, V_c , and development lengths.¹²

$f'_c \leq 100$ psi. Eq. 2-12 Equations 2-10 and 2-12 are used internally and cannot be modified.

The average split tensile strength is used to compute the modulus of rupture and reinforcement development lengths. For normal weight concrete, the default value of f_{ct} used by pcaSlab is set equal to:¹³

$$f_{ct} = 6.7\sqrt{f'_c} \quad \text{Eq. 2-13}$$

In no case will $f_{ct}/6.7$ exceed 100 psi. The value f_{ct} will be modified according to the concrete type. Table 2-3 shows the default values for f_{ct} for different concrete types. No interpolation is performed for partial sand replacement.

Type	f_{ct}
Normal	$6.7\sqrt{f'_c}$
Sand-Lightweight	$(0.85) 6.7\sqrt{f'_c}$
All-Lightweight	$(0.75) 6.7\sqrt{f'_c}$

Table 2-2 Default Average Splitting Tensile Strength

The modulus of rupture is used to determine the cracking moment when computing the effective moment of inertia for deflection computations. The default value of modulus of rupture, f_r , is for ACI 318 code set equal to:

$$f_r = 1.12 f_{ct} . \quad \text{Eq. 2-14}$$

If f_{ct} is that given in . 2-13, . 2-14 becomes:¹⁴

$$f_r = 7.5 \sqrt{f'_c} . \quad \text{Eq. 2-15}$$

¹² ACI 318-99, 11.1.2; ACI 318-02, 11.1.2

¹³ ACI 318-99, 9.5.2.3; ACI 318-02, 9.5.2.3

¹⁴ ACI 318-99, 9.5.2.3; ACI 318-02, 9.5.2.3; CSA A23.3-94, 8.6.4 & 13.3.6

For CSA A23.3 standard, the default value of modulus of rupture, f_r , is

$$f_r = 0.6 \sqrt{f'_c}, \quad \text{Eq. 2-16}$$

for beams and columns and

$$f_r = \frac{0.6 \sqrt{f'_c}}{2}, \quad \text{Eq. 2-17}$$

for slabs.

There is no limit imposed on f_r . Entering a large value of f_r will produce deflections based on gross properties, (i.e., uncracked sections).

The default values for the longitudinal reinforcement yield strength, f_y , and shear reinforcement yield strength, f_{yv} , if applicable, are set equal to 60 ksi (413 MPa) for ACI and 400 MPa for CSA.

The Equivalent Frame Method

The equivalent frame method, as described in the Code¹⁵, is used by pcaSlab for both analysis and design. The Code specifies procedures for the analysis and design of slab systems reinforced for flexure in more than one direction, with or without beams between the supports. A two-way slab¹⁶ system, including the slab and its supporting beams, columns, and walls may be designed by either of the following procedures:

- The Direct Design Method
- The Equivalent Frame Method

pcaSlab uses the Equivalent Frame Method of analysis. It should be noted that this method is based on extensive analytical and experimental studies conducted at the University of Illinois. Note also that there are no restrictions on the number of slab spans or on dead-to-live load ratios in this method of analysis.

The first step in the frame analysis is to divide the three-dimensional building into a series of two-dimensional frames extending to the full height of the building. Horizontal members for each frame are formed by slab strips as shown in Fig. 2-5.

¹⁵ ACI 318-99, Chapter 13; ACI 318-02, Chapter 13; CSA A23.3-94, Clause 13

¹⁶ Implies a slab supported by isolated supports which permits the slab to bend in two orthogonal directions.

For vertical loads, each storey (floor and/or roof) may be analyzed separately with the supporting columns being considered fixed at their remote ends. (Figure 2-6).

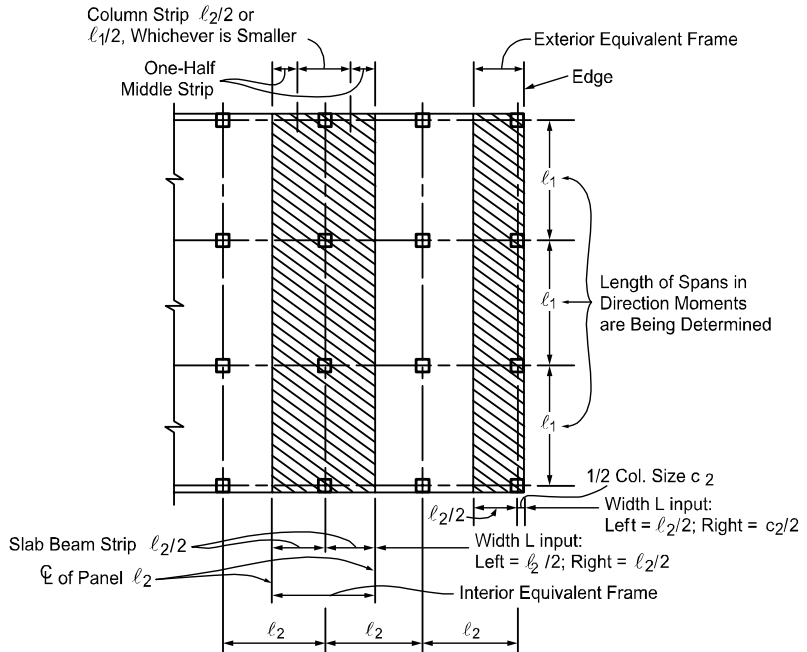

Figure 2-5 Design strips

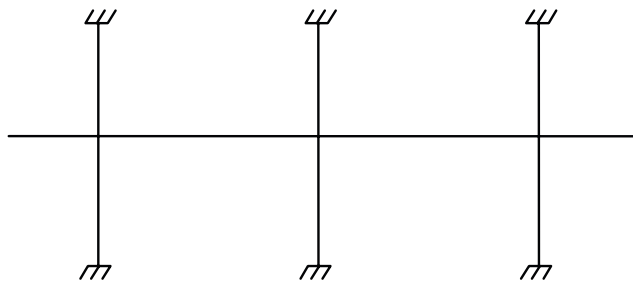

Figure 2-6 Analytical model for vertical loads for a typical storey

Stiffness Characteristics



The stiffness factors for the horizontal members (the slab beams) and the vertical members (the equivalent columns) are determined using segmental approach.

Slab Beams



The moment of inertia of the slab beam elements between the faces of the columns (or column capitals) is based on the uncracked section of the concrete including beams or drop panels. The moment of inertia from the face of the column (or capital) to the centerline of the column (or capital) is considered finite and is dependent on the transverse dimensions of the panel and support. This reduced stiffness (as compared to the infinite stiffness assumed in previous codes) is intended to soften the slab at the joint to account for the flexibility of the slab away from the support. This is consistent with provisions of the Code.¹⁷

Figure 2-7 shows the changes in stiffness between a slab, and a drop panel, and a column (or capital).

Columns



The computation of the column stiffness is more complicated as it utilizes the concept of an equivalent column. Theoretical slab studies have shown that the positive moment in a slab may increase under pattern loads, even if rigid columns are used, because of the flexibility of the slab away from the column. However, if a two-dimensional frame analysis is applied to a structure with rigid columns, pattern loads will have little effect. To account for this difference in behavior between slab structures and frames, the equivalent column torsional member, as shown in Figure 2-8, runs transverse to the direction in which the moments are being determined. The transverse slab beam can rotate even though the column may be infinitely stiff, thus permitting moment distribution between adjacent panels. It is seen that the stiffness of the equivalent column is affected by both the flexural stiffness of the columns and the torsional stiffness of the slabs or beams framing into the columns. Note that the method of computation of column stiffness is in accordance with the requirements of the Code¹⁸. Figure 2-9 shows a schematic representation of the stiffness of typical columns.

¹⁷ ACI 318-99, 13.7.3; ACI 318-02, 13.7.3; CSA A23.3-94, 13.9.2.3

¹⁸ ACI 318-99, 13.7.4; ACI 318-02, 13.7.4; CSA A23.3-94, 13.9

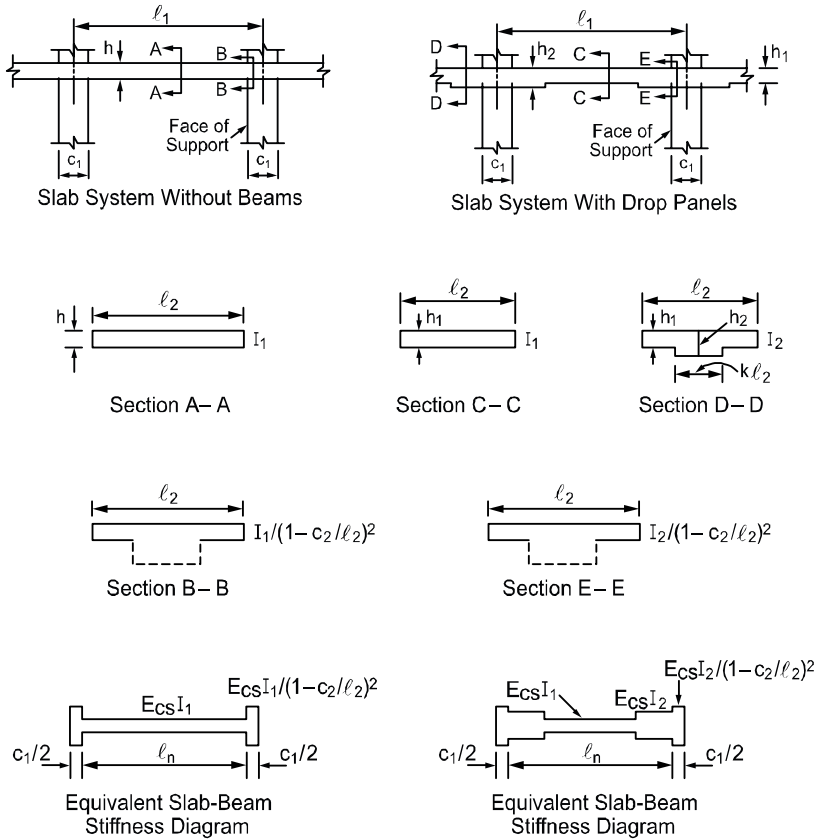

Figure 2-7 Sections for calculating slab-beam stiffness, K_{sb}

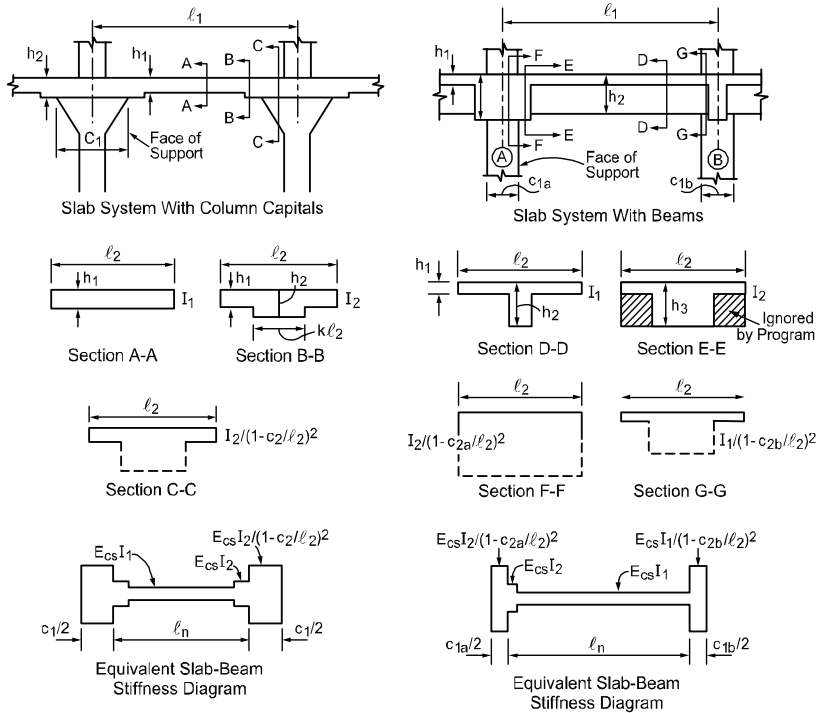

Figure 2-7 continued

The column stiffness is based on the column height, l_c , measured from mid-depth of the slab above, to the mid-depth of the slab below. pcaSlab calculates the stiffness of the column below the design slab, taking into account the design slab system at its top end. pcaSlab calculates the stiffness of the column above the design slab taking only the slab depth into account at its top end; column capitals, beams, or drops are ignored.

The computation of the torsional stiffness of the member requires several simplifying assumptions. The first step is to assume dimensions of the transverse torsional slab-beam members. Assumptions for dimensions of typical torsional members are shown in Figure 2-10.

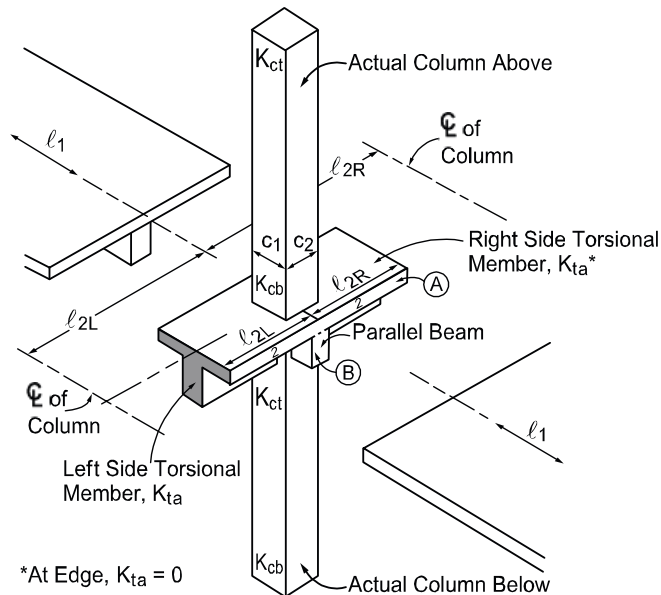

Figure 2-8 The equivalent column

The stiffness, K_t , of the torsional member is given by the following expression¹⁹:

$$K_t = \sum \frac{9 E_{cs} C}{l_2 \left(1 - \frac{c_2}{l_2} \right)^3}, \quad \text{Eq. 2-18}$$

where:

- E_{cs} = modulus of elasticity for slab concrete,
- C = cross-sectional constant defining torsional properties; see . 2-19 (it is a conservatively low approximation of the torsional rigidity of rectangular sections when assuming elastic behavior), for the CSA Standard l_2 is taken as the smaller of l_2 or l_1 ,
- c_2 = size of rectangular column or capital measured transverse to the direction in which moments are being determined,
- l_2 = for ACI 318, length of span transverse to l_1 , measured on each side of the column, for CSA A23.3-94 l_2 is taken as the smaller of l_2 or l_1 .

¹⁹ ACI 318-99, 13.7.5; ACI 318-02, 13.7.5; CSA A23.3-94, Eq. 13.13

The constant C is evaluated for the cross section by dividing it into separate rectangular parts and by carrying out the following summation²⁰:

$$C = \sum \left(1 - 0.63 \frac{x}{y} \right) \frac{x^3 y}{3} \quad \text{Eq. 2-19}$$

where:

- x = short overall dimension of the rectangular part of a cross section,
- y = long overall dimension of the rectangular part of a cross section.

As a result of $K_t = \sum \frac{9 E_{CS} C}{l_2 \left(1 - \frac{c_2}{l_2} \right)^3}$, Eq. 2-18, walls²¹ running the full width of a slab ($c_2 = l_2$) cannot be modeled by the Equivalent Frame Method.

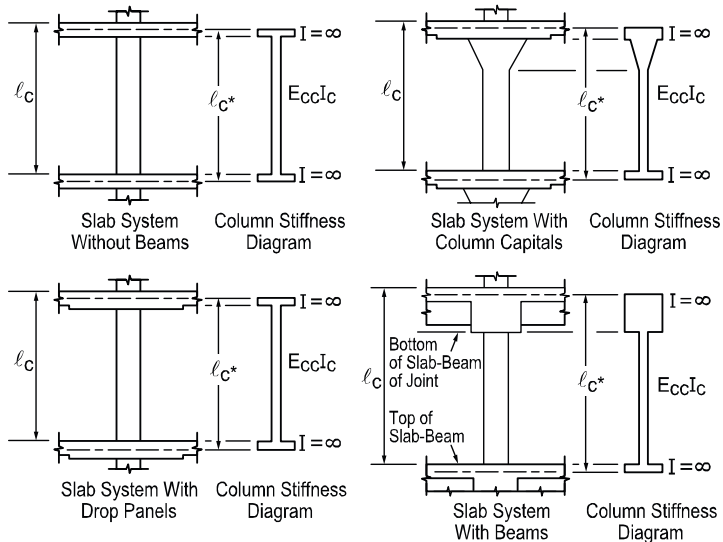

Figure 2-9 Sections for calculating the stiffness (K_c) of the column below the design floor (l_c -input, l_c^* -computed)

²⁰ ACI 318-99, 13.0; ACI 318-02, 13.0; CSA A23.3-94, Eq. 13-14

²¹ Instead walls can be modeled as long supports less than the full design width of the slab. To obtain a uniform distribution of the end moment along the column and middle strips, the width of the wall must be greater than 75% of the design strip.

When beams frame into the column in the direction of analysis, the value of K_t as computed in 2-18 is multiplied by the ratio of the moment of inertia of the slab with the beam (I_{sb}) to the moment of inertia of the slab without the beam (I_s), as shown:

$$K_{ta} = K_t \frac{I_{sb}}{I_s} \quad \text{Eq. 2-20}$$

With reference to Figure 2-8, I_s is computed from part A (slab without beam), whereas I_{sb} is computed from both parts A and B (slab with beam).

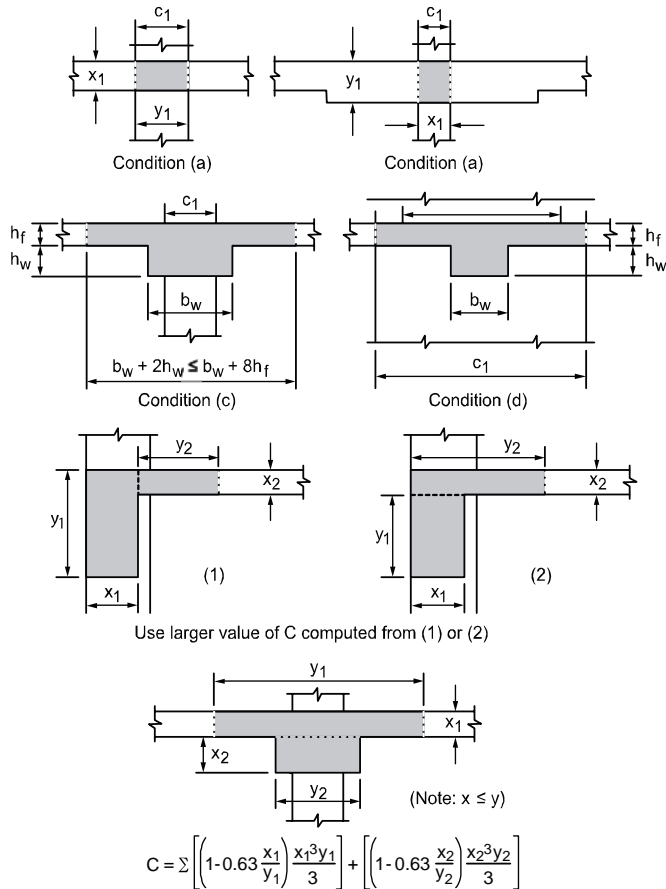

Figure 2-10 Section of the attached torsional members

Knowing the column stiffness, K_c , and the stiffness of the attached torsional member, K_t , the stiffness of the equivalent column, K_{ec} , is computed from the equation:

$$K_{ec} = \frac{K_{ct} + K_{cb}}{1 + \frac{K_{ct} + K_{cb}}{K_{ta} + K_{tb}}}, \quad \text{Eq. 2-21}$$

where:

- K_{ct} = top column stiffness,
- K_{cb} = bottom column stiffness,
- K_{ta} = the stiffness of the left and right torsional member.

Loading

All applied loads are input as unfactored loads. There are no limitations imposed on the ratio of dead to live loads in the Equivalent Frame Method. Results of gravity load and lateral load analyses may be combined, however, the effects of cracking and reinforcement on stiffness must be accounted for in the lateral load analysis.

Self-Weight

The self-weight of the floor system is computed internally by pcaSlab. The weights of the slabs, drops, and longitudinal and transverse beams are considered in the self weight computations. Only the concrete weight is considered, the reinforcement weight is ignored. The weight of longitudinal beams is ignored starting at the column centerline, for a length equal to one-half c_1 , the column dimension in the direction of analysis. This will produce slightly less self-weight than actually present for beams wider than c_2 , the column's transverse dimension.

Superimposed Loading

All superimposed vertical loading is considered to act over the entire transverse width of the slab. For slab systems with beams, loads supported directly by the beam (such as the weight of the beam stem or a wall supported directly by the beams) are also assumed to be distributed over the entire transverse width of the strip. An additional analysis may be required, with the beam section designed to carry these loads in addition to the portion of the slab moments assigned to the beam.

Lateral Loading

For lateral loads, each frame should be analyzed as a unit for the entire height of the building (Figure 2-11). Computer programs, such as *pcaFrame*, are available for performing such analyses. It should be realized that, for lateral load analysis, slab-beam elements may have a reduced stiffness due to cracking as well as other assumptions made for the effective slab width used for the lateral analysis. The moments obtained from such an analysis may then be input into the equivalent frame model using *pcaSlab* to determine the appropriate design moments under combined vertical and lateral loads.

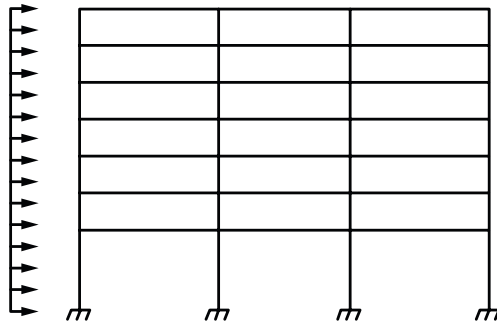

Figure 2-11 Analytical model for lateral loads

By default, *pcaSlab* distributes the effect of lateral load moment, the difference between the total load moments, vertical plus lateral, and the vertical only moment envelopes, to the column strip and middle strip according to the code distribution factors computed for vertical loads (see Table 2-3 through Table 2-5 later in this chapter).

Loading Patterns

The analysis of floor systems requires the consideration of several loading configurations. For example, the two adjacent spans loaded may produce the maximum shear stress around a column, while the alternate spans loaded may produce the maximum flexural moments. To cover different loading scenarios *pcaSlab* generates live load case based on the following load patterns (Figure 2-12):

- loading Pattern No. 1: All spans loaded with live load (LALL),
- loading Pattern No. 2: Alternate (odd) spans loaded with live load (LODD),
- loading Pattern No. 3: Alternate (even) spans loaded with live load (LEVEN),

- loading Pattern No. 4: Two adjacent spans loaded with live load (LSUPP).

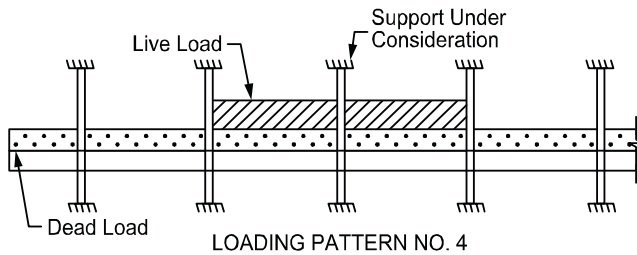
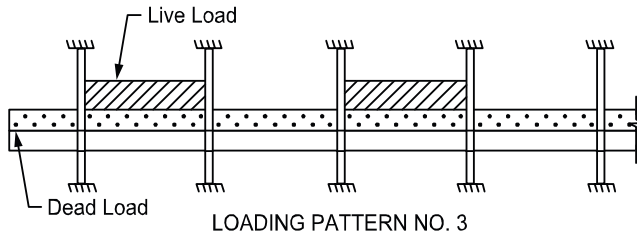
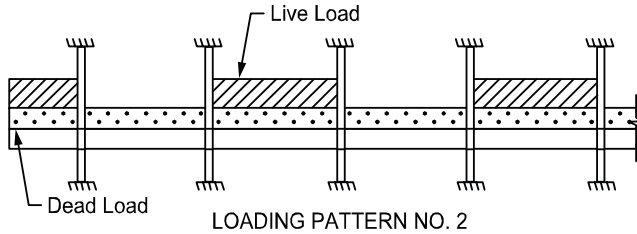
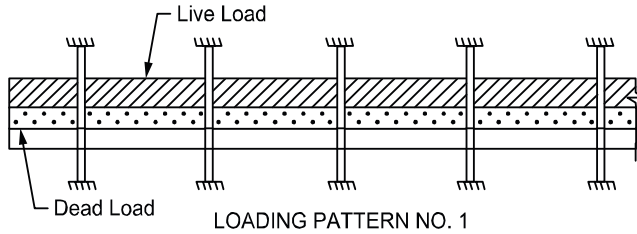

Figure 2-12 Basic pattern live loads

pcaSlab reduces the magnitude of live load patterns No.2 through No.4 by a predefined ratio. For two-way systems, the default live load pattern ratio selected

by the program equals 75% as permitted by the code²². The user has the ability to select different value for the pattern ratio within the range 0-100%. If 0% is selected than no load patterning is considered. However, the pattern No.1 with all spans loaded (as specified by the user) is always considered with full unreduced magnitude.

Load Combinations

pcaSlab allows defining up to 20 load combinations. The user has full control over the combinations. The program contains predefined (build into the program) default primary load combinations for the supported codes. These default combinations are created when starting a new project.

For the ACI 318-99 Code, the default combinations of the Dead (D), Live (L), Wind (W) and Earthquake (E) loads considered by the program are:

$$\begin{aligned}
 U_1 &= 1.4D + 1.7L, \\
 U_2 &= 0.75(1.4D + 1.7L + 1.7W), \\
 U_3 &= 0.75(1.4D + 1.7L - 1.7W), \\
 U_4 &= 0.75(1.4D + 1.7W), \\
 U_5 &= 0.75(1.4D - 1.7W), \\
 U_6 &= 0.9D + 1.3W, \\
 U_7 &= 0.9D - 1.3W, \\
 U_8 &= 0.75(1.4D + 1.7L + 1.7*1.1E), \\
 U_9 &= 0.75(1.4D + 1.7L - 1.7*1.1E), \\
 U_{10} &= 0.75(1.4D + 1.7*1.1E), \\
 U_{11} &= 0.75(1.4D - 1.7*1.1E), \\
 U_{12} &= 0.9D + 1.43E, \\
 U_{13} &= 0.9D - 1.43E.
 \end{aligned}$$

For the ACI 318-02 Code, the default combinations of the Dead (D), Live (L), Wind (W) and Earthquake (E) loads considered by the program are:

$$\begin{aligned}
 U_1 &= 1.4D, \\
 U_2 &= 1.2D + 1.6L, \\
 U_3 &= 1.2D + 1.6L + 0.8W, \\
 U_4 &= 1.2D + 1.6L - 0.8W, \\
 U_5 &= 1.2D + 1.0L + 1.6W, \\
 U_6 &= 1.2D + 1.0L - 1.6W, \\
 U_7 &= 0.9D + 1.6W, \\
 U_8 &= 0.9D - 1.6W,
 \end{aligned}$$

²² ACI 318-99, 13.7.6.3; ACI 318-02, 13.7.6.3; CSA A23.3-94, 13.9.4

$$\begin{aligned} U_9 &= 1.2D + 1.0L + 1.0W, \\ U_{10} &= 1.2D + 1.0L - 1.0W, \\ U_{11} &= 0.9D + 1.0W, \\ U_{12} &= 0.9D - 1.0W. \end{aligned}$$

For the CSA A23.3 Code, the default combinations of the Dead (D), Live (L), Wind (W) and Earthquake (E) loads considered by the program are:

$$\begin{aligned} U_1 &= 1.25D + 1.5L, \\ U_2 &= 1.25D + 0.7(1.5L + 1.5W), \\ U_3 &= 1.25D + 0.7(1.5L - 1.5W), \\ U_4 &= 0.85D + 1.5W, \\ U_5 &= 0.85D - 1.5W, \\ U_6 &= 1.0D + 0.5L + 1.0E, \\ U_7 &= 1.0D + 0.5L - 1.0E, \\ U_8 &= 1.0D + 1.0E, \\ U_9 &= 1.0D - 1.0E. \end{aligned}$$

Column and Middle Strip Widths

The Code²³ defines the width of the column strip on each side of the column centerline as being one-fourth of the smaller of either the transverse or the longitudinal span. These widths are printed as part of the echo of input data.

The strip widths at a support are computed by (see Figure 2-13)

- column strip

$$W_{CS} = \min \left\{ \begin{array}{l} \min \left\{ \frac{l_{2,l}}{2}, \frac{l_l}{4} \right\}_i + \min \left\{ \frac{l_{2,r}}{2}, \frac{l_l}{4} \right\}_i \\ \min \left\{ \frac{l_{2,l}}{2}, \frac{l_l}{4} \right\}_{i+1} + \min \left\{ \frac{l_{2,r}}{2}, \frac{l_l}{4} \right\}_{i+1} \end{array} \right\}, \quad \text{Eq. 2-22}$$

- middle strip

$$W_{MS} = \min \{ l_{2,i}, l_{2,i+1} \} - W_{CS}. \quad \text{Eq. 2-23}$$

²³ ACI 318-99, 13.2.1; ACI 318-02, 13.2.1; CSA A23.3-94, 13.1

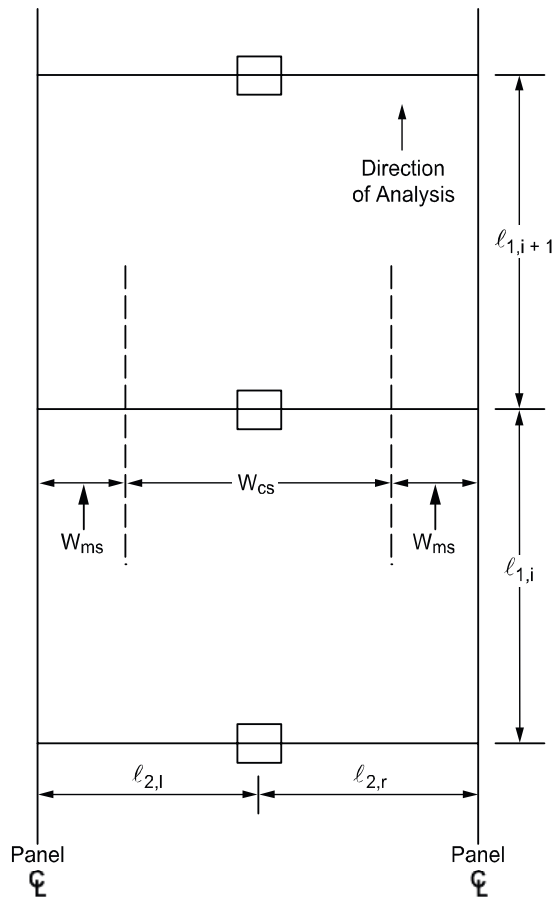

Figure 2-13 Strips widths at support

The strip widths in the span are defined as (see Figure 2-14):

- column strip

$$W_{CS} = \min\left\{\frac{l_{2,l}}{2}, \frac{l_1}{4}\right\} + \min\left\{\frac{l_{2,r}}{2}, \frac{l_1}{4}\right\}, \quad \text{Eq. 2-24}$$

- middle strip

$$W_{MS} = l_2 - W_{CS}, \quad \text{Eq. 2-25}$$

where:

- l_1 = span length in the direction of analysis,
- l_2 = the total input transverse strip width,
- $l_{2,l}$ = the input transverse strip widths on the left of column centerline,
- $l_{2,r}$ = the input transverse strip widths on the right of column centerline,
- i = span left and right of column centerline,
- $i+1$ = span left and right of column centerline.

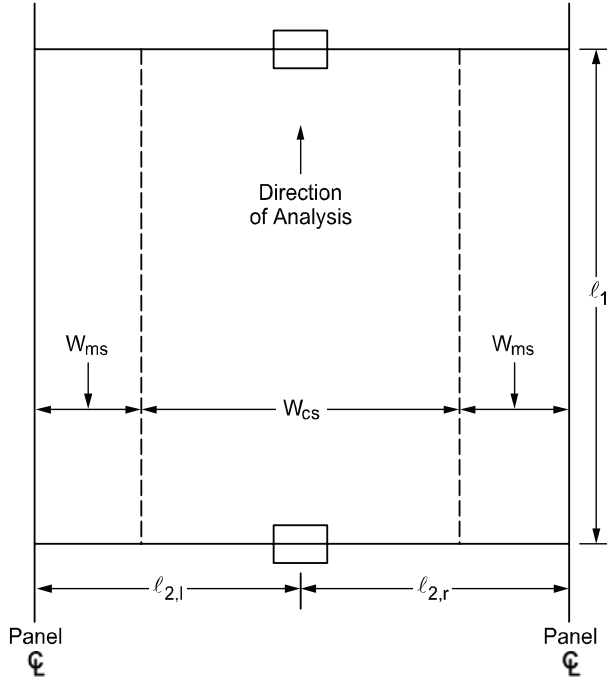

Figure 2-14 Strip widths in span

If a beam exists

$$W_{cs} = W_{cs} - W_b \quad \text{Eq. 2-26}$$

where:

W_b = beam width.

If the beam width, W_b , is greater than the column strip width, W_{cs} , then an error message is displayed and the solution is aborted. This usually happens when

modeling a banded-beam system as a two-way slab with a wide beam. In this case, it is suggested that wide beams are modeled separately in one direction, and in the other direction one-way slab supported by beams is modeled.

For exterior frames, the edge width should be specified to the edge of the slab from the column centerline.

Strip Design Moments

pcaSlab considers negative moments for design purposes as those producing tension at the top of the slab. The negative design moment is taken at a section located at the face of the column, or column capital, but in no case is it considered at a location greater than 0.175 of the longitudinal span length, l_1 , away from the center of the column.²⁴ This imposes a limit on long narrow supports, in order to prevent undue reduction in the design moment. For slab systems with transverse beams, the face of a beam is not considered as the face of support. For end columns with capitals, the moments are taken at the midpoint of the capital extension.²⁵ The column and middle strip moments correspond to the moments assigned to the slab element only.

The column strips are proportioned to resist the portions in percent of interior negative factored moments according to Table 2-3.²⁶

L_2/l_1	0.5	1.0	2.0
$(\alpha_1 l_2/l_1) = 0$	75	75	75
$(\alpha_1 l_2/l_1) \geq 1.0$	90	75	45

Table 2-3 Column Strip Percent of Interior Negative Factored Moments at Supports

The column strips are proportioned to resist the portions in percent of exterior negative factored moments according to Table 2-4.²⁷

²⁴ ACI 318-99, 13.7.7.1; ACI 318-02, 13.7.7.1; CSA3-A23.3-94, 13.9.5.1

²⁵ ACI 318-99, 13.7.7.2; ACI 318-02, 13.7.7.2; CSA3-A23.3-94, 13.9.5.2

²⁶ ACI 318-99, 13.6.4.1; ACI 318-02, 13.6.4.1; CSA3-A23.3-94, 13.9.5.1

²⁷ ACI 318-99, 13.6.4.2; ACI 318-02, 13.6.4.2

l_2/l_1		0.5	1.0	2.0
$(\alpha_1 l_2/l_1) = 0$	$\beta_t = 0$	100	100	100
	$\beta_t \geq 2.5$	75	75	75
$(\alpha_1 l_2/l_1) \geq 1.0$	$\beta_t = 0$	100	100	100
	$\beta_t \geq 2.5$	90	75	45

Table 2-4 Column Strip Percent of Exterior Negative Factored Moments at Supports

The values α_1 in Table 2-3 and Table 2-4 and β_t in Table 2-4 are defined as:

- α_1 = ratio of flexural stiffness of the beam section to flexural stiffness of a width of slab bounded by centerlines of adjacent panels (if any) on each side of the beam in the direction of analysis. For flat plates, flat slabs, and waffle $\alpha_1 l_2/l_1 = 0$
- β_t = ratio of torsional stiffness of an edge beam section to flexural stiffness of a width of slab equal to the span length of the beam, center-to-center of supports.²⁸ When no transverse beams are present, $\beta_t = 0$, otherwise

$$\beta_t = \frac{E_{cb}C}{2E_{cs}I_s}, \quad \text{Eq. 2-27}$$

where:

- E_{cb} = modulus of elasticity of beam concrete,
 E_{cs} = modulus of elasticity of slab concrete,
 C = cross-sectional constant to define torsional properties; see . 2-19,
 I_s = moment of inertia of the gross section of the slab about its centroidal axis.

For intermediate values of (l_2/l_1) , $(\alpha_1 l_2/l_1)$ and β_t , the values in Table 2-3 and Table 2-4 are interpolated using equations . 2-28 and . 2-29.

Percentage of negative factored moment at interior support to be resisted by column strip:

$$75 + 30 \left(\frac{\alpha_1 l_2}{l_1} \right) \left(1 - \frac{l_2}{l_1} \right). \quad \text{Eq. 2-28}$$

Percentage of negative factored moment at exterior support to be resisted by column strip:

²⁸ ACI 318-99, 13.0; ACI 318-02, 13.0; CSA3-A23.3-94, 13.0

$$100 - 10 \beta_t + 12 \beta_t \left(\frac{\alpha_1 l_2}{l_1} \right) \left(1 - \frac{l_2}{l_1} \right). \quad \text{Eq. 2-29}$$

When a column width, c_2 , is equal to or greater than 75 percent of the strip width, l_2 the negative moment is uniformly distributed across l_2 .²⁹

When designing by the CSA A23.3-94 Code, a portion of the total positive or interior negative moment equivalent to:

$$\frac{\alpha_1}{\left[1 + \left(\frac{l_2}{l_1} \right)^2 \right]}, \quad \text{Eq. 2-30}$$

is resisted by the beam. For exterior supports the beam is proportioned to resist 100% of the negative moment.

That portion of the moment not resisted by the beam is resisted by the slab. The reinforcement required to resist this moment is distributed evenly across the slab.

For ACI designs the longitudinal beams are proportioned to resist 85 percent of the column strip moments if $\alpha_1 l_2 / l_1$ is equal to or greater than 1.0. For values of $\alpha_1 l_2 / l_1$ between 0 and 1.0, the beam is designed to resist a proportionate percentage of the column strip moment between 0 and 85%.³⁰

When lateral loads are present, pcaSlab, by default, distributes the effects of lateral loads according to Table 2-1 and Table 2-4.

The middle strips are proportioned to resist the portion of the total factored moments that is not resisted by the column strips.

For design purposes, pcaSlab computes the amount of reinforcement for the moments on the left and right sides of the support. The negative design moment is the moment which requires the most area of reinforcement to be resisted. The location, left or right of the support, of the maximum moment may vary when systems differ on each side of the support (for example, a system with beams on one side only). pcaSlab considers positive moments for design purposes as those producing tension at the bottom of the slab. The column strips are proportioned to

²⁹ ACI 318-99, 13.6.4.3; ACI 318-02, 13.6.4.3

³⁰ ACI 318-99, 13.6.5; ACI 318-02, 13.6.5

resist the portions in percent of positive factored moments according to Table 2-5.³¹

l_2/l_1	0.5	1.0	2.0
$(\alpha_1 l_2/l_1) = 0$	60	60	60
$(\alpha_1 l_2/l_1) \geq 1.0$	90	75	45

Table 2-5 Column Strip Percent of Positive Factored Moments

For intermediate values of (l_2/l_1) and $(\alpha_1 l_2/l_1)$ the values in Table 2-5 are interpolated using . 2-31 as follows:

$$60 + 30 \left(\frac{\alpha_1 l_2}{l_1} \right) \left(1.5 - \frac{l_2}{l_1} \right). \quad \text{Eq. 2-31}$$

The middle strips are proportioned to resist the remainder of the total factored moments.

Note: For flat plates, flat slabs, and waffle slabs, $\alpha_1 l_2/l_1 = 0$.

Moment Redistribution

Redistribution of negative moments applies to one-way and beam systems only. It can be engaged using the **Input Redistribution** radio button on the **Solve Options** tab in the **General Information** dialog box.

pcaSlab allows for redistribution of negative moments at supports. Only reduction in negative moments is considered. Increase of negative moments at the support is not taken into account even though it is allowed by the code³². Static equilibrium is maintained meaning that bending moments and shear forces along the span are adjusted in accordance with the reduction of moments applied at the supports. The following procedure is followed to obtain moment redistribution factors at the supports.

From elastic static analysis, the largest moments from all load combinations and load patterns are determined at support faces on both ends of each span except cantilevers. These moments are used to calculate the maximum percentage adjustment of moments, δ , allowed by the codes.

For ACI 318-02:

³¹ ACI 318-99, 13.6.4.4; ACI 318-02, 13.6.4.4

³² ACI 318-99, 8.4.1; ACI 318-02, 8.4.1; CSA A23.3-94, 9.2.4

$$\delta = \begin{cases} 0, & \text{if } \varepsilon_t < 0.0075, \\ 1000 \cdot \varepsilon_t, & \text{if } \varepsilon_t \geq 0.0075, \end{cases} \quad \text{Eq. 2-32}$$

where ε_t is net tensile strain in extreme tension steel at nominal strength.

For ACI 318-99:

$$\delta = \begin{cases} 0, & \text{if } (\rho - \rho') > 0.5\rho_b, \\ 20 \left(1 - \frac{\rho - \rho'}{\rho_b} \right), & \text{if } (\rho - \rho') \leq 0.5\rho_b, \end{cases} \quad \text{Eq. 2-33}$$

where:

- ρ = tension reinforcement ratio,
- ρ' = compression reinforcement ratio,
- ρ_b = balanced reinforcement ratio.

For CSA A23.3-94:

$$\delta = 30 - 50 \frac{c}{d}, \quad \text{Eq. 2-34}$$

where:

- c = distance from extreme compression fiber to neutral axis,
- d = distance from extreme compression fiber to centroid of tension reinforcement.

In the investigation mode, program uses the area of provided reinforcement to obtain redistribution factors. In the design mode the required reinforcement area is used. Additionally, δ is checked not to exceed 20% and not to exceed the maximum values specified by the user. Negative moments at span ends are reduced by the amount of redistribution factors and new moment values are iteratively used to obtain new redistribution factors. This iterative procedure is repeated until the change in distribution factor does not exceed 0.01% but no more than 10 times.

Shear Analysis of Slabs

Three types of shear can occur on slab systems: wide beam shear, punching shear, and moment transfer shear. pcaSlab checks wide beam shear at a critical section located at a distance equal to the effective depth away from the face of the supports. The tributary area for wide beam shear calculations extends from the

critical section to the center of the span. For punching shear including moment transfer shear it is assumed that both types of shear act on the same critical section. The critical section for shear is defined in the Code.³³

Figure 2-15 shows the general punching shear area used by pcaSlab. Note that the shaded area represents the general case and is modified for special considerations as explained below.

Shallow beams are considered in the unbalanced moment transfer as indicated in Figure 2-15 by areas B₁, B₂, B₃, B₄, B₅, and B₆. Ordinarily, transverse beams transfer unbalanced moment to the column through torsion along the beam and not through shear between the slab and column. However, the Code leaves the transfer method to the engineer's judgment concerning the point at which punching shear is no longer applicable and beam shear becomes the dominate element in shear transfer to the column. pcaSlab makes no such distinction and computes unbalanced moment transfer stress without regard to any beams framing into the column. Although the depth of the beam is considered in the critical section surfaces, the distances to the critical section are not increased at the intersection with any beams. This approach is conservative. pcaSlab does not compute torsional stresses in the slab. If in the engineer's judgment this may control, it must be computed manually.

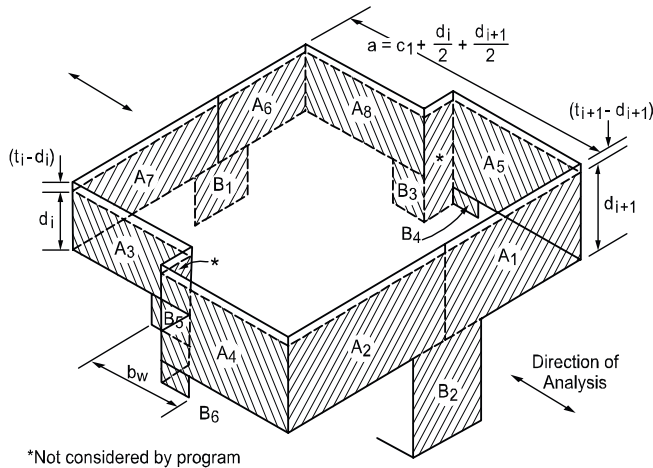

Figure 2-15 Critical section for shear at column

³³ ACI 318-99, 11.12.1.2; ACI 318-02, 11.12.1.2; CSA A23.3-94, 13.4.3

For a circular column or column capital, a square shape with an equivalent area is assumed as shown in Figure 2-16. Critical section area for punching, A_c , is then multiplied by $\pi(D+d)/(2D\sqrt{\pi}+4d)$ to account for the difference between circular and square critical sections, where D is the diameter of a column or a column capital and d is the effective depth of the slab.

The critical section is considered closed if the concrete slab around a column extends to a distance greater than or equal to the specified threshold value. In pcaSlab the user may define the distance extended beyond the column face in order to consider the section closed. The default value for this distance is ten times the slab thickness ($10h$) as required by ACI code. If the critical section does not meet the distance requirement it is considered open.

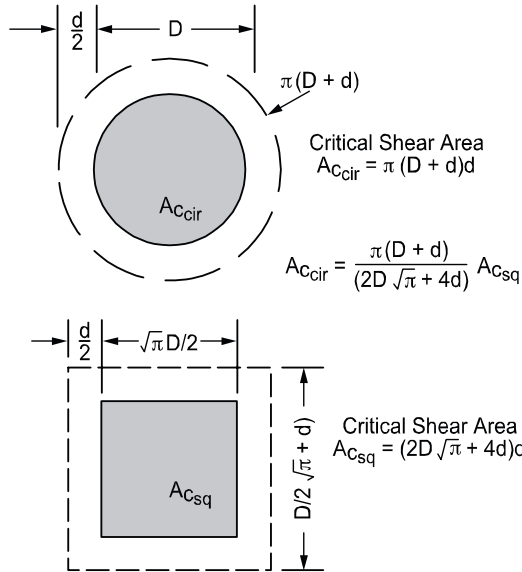

Figure 2-16 Critical section area for circular column

Critical Section for Interior Supports of Interior Frames

The critical section (Figure 2-17) consists of four vertical surfaces through the slab, located at distances of $d/2$ beyond the support faces.

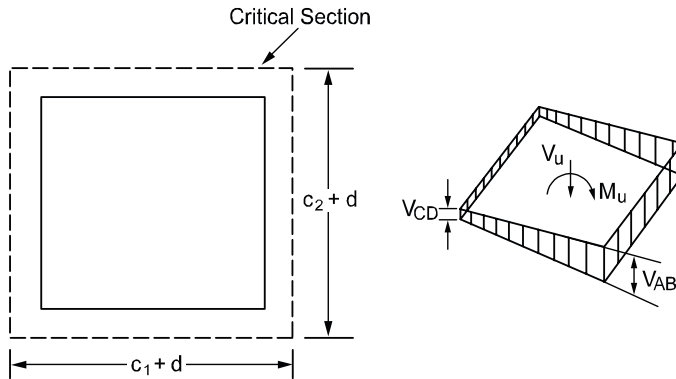

Figure 2-17 Interior supports of interior frames

The critical section for interior supports of interior frames is always closed. A closed section will have all its faces defined in Figure 2-15 resisting shear as indicated by . 2-35:

$$A_C = \sum_{i=1}^8 A_i . \quad \text{Eq. 2-35}$$

If beams frame³⁴ into the column, then the critical section includes the dimensions of the beams (B₁ through B₆ in Figure 2-15).

Critical Section for Exterior Supports of Interior Frames

The critical section for exterior supports of interior frames (Figure 2-18) will be either closed (full A₇ and A₆ for the first column or A₁ and A₂ for the last column in Figure 2-15) or open, depending upon the length of the cantilever in relation to slab thickness. The critical section will be considered closed when the clear cantilever span, l_c, is greater than or equal to the distance defined by the user beyond the column face (the default value is 10 h). If beams frame into the column, then the critical section includes the contributions from the beam dimensions (B₁ through B₆ in Figure 2-16).

³⁴ A beam is considered as framing into the column if the beam is within a face of the column.

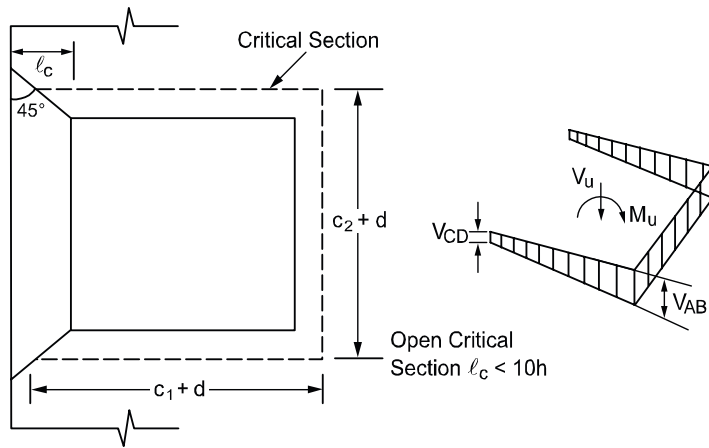

Figure 2-18 Exterior supports of interior frames

Critical Section for Interior Supports of Exterior Frames

Figure 2-19 shows the critical section for shear for an interior support of an exterior frame. Note that the section is considered as U-shaped ($A_5 = 0$, $A_8 = 0$, $B_3 = 0$, $B_4 = 0$ in Figure 2-15) and it extends up to the edge of the exterior face of the support. If beams frame into the column, then the critical section includes the contribution from the beam dimensions (B_1 through B_6 in Figure 2-15). If the exterior cantilever span is greater than or equal to the distance defined by the user beyond the column face (the default value is $10h$), the section is treated as closed, that is, the support is treated as an interior support of an interior frame.

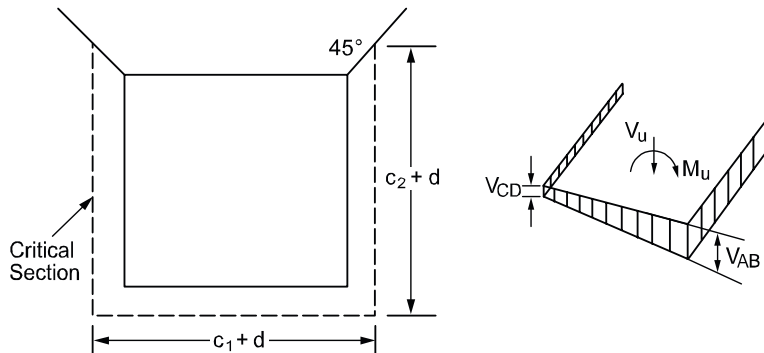

Figure 2-19 Interior supports of exterior frames

Critical Section for Exterior Supports of Exterior Frames

pcaSlab

The critical section for an exterior support of an exterior frame will typically be L-shaped ($A5 = 0$, $A6 = 0$, $A7 = 0$, $A8 = 0$, $B1 = 0$, $B3 = 0$, and $B4 = 0$ in Figure 2-15).

If the cantilever span l_c (in the direction of analysis) is greater than or equal to the distance defined by the user beyond the column face (the default value is $10h$), then the section is treated as a U-shaped interior support. If, in addition, the cantilever span in transverse direction is greater than or equal to the distance defined by the user beyond the column face (the default value is $10h$), the section is treated as closed. If beams frame into the column, then the critical section includes the contributions from the beam dimensions.

Computation of Allowable Shear Stress at Critical Section

pcaSlab

One-way shear strength of slabs is limited³⁵ to $2\sqrt{f'_c}$. Two-way shear strength of slabs is affected by concrete strength, relationship between size of loaded area and slab thickness, loaded area aspect ratio, and shear-to-moment ratio at slab-column connections.

For the ACI 318-99, ACI 318-02 and CSA A23.3-94 Code, these variables are taken into account in the allowable shear stress Eqs. 2-36 through 2-39. The allowable shear stress used by pcaSlab is computed at distances of $d/2$ around the columns and drops (if applicable) and taken as the smallest of the 3 quantities:³⁶

$$v_c = \left(2 + \frac{4}{\beta_c} \right) \sqrt{f'_c}, \quad \text{Eq. 2-36}$$

$$v_c = \left(2 + \frac{\alpha_S d}{b_0} \right) \sqrt{f'_c}, \quad \text{Eq. 2-37}$$

$$v_c = 4\sqrt{f'_c}, \quad \text{Eq. 2-38}$$

where

β_c = the ratio of the long to the short side of the column.

³⁵ ACI 318-99, 11.3.1.1; ACI 318-02, 11.3.1.1

³⁶ ACI 318-99, 11.12.2.1; ACI 318-02, 11.12.2.1; CSA A23.3-94, 13.4.4

- α_s = a constant dependent of the column location, (40 for an interior 4-sided effective critical area, 30 for an exterior 3-sided critical area, 20 for a corner 2-sided effective critical area.)
- d = distance from the slab bottom to centroid of the slab tension reinforcement at support.
- b_0 = the perimeter of the critical section.

The allowable shear stress around drops when waffle slabs are used is computed as:

$$v_c = \begin{cases} 2\sqrt{f'_c} & \text{for ACI,} \\ 0.2 \phi_c \sqrt{f'_c} & \text{for CSA,} \end{cases} \quad \text{Eq. 2-39}$$

where:

- ϕ_c = resistance factor for concrete.

For waffle slab systems with valid ribs defined earlier in this chapter, the allowable shear stress is increased by 10% for ACI designs.³⁷

Computation of Factored Shear Force at Critical Section

pcaslab

The factored shear force V_u on the critical section, is by default computed as the reaction at the centroid of the critical section (e.g., column centerline for interior columns) minus the self-weight and any superimposed surface dead and live load acting within the critical section. If the section is considered open, two 45 degree lines are drawn from the column corners to the nearest slab edge (lines AF and DE in Figure 2-19) and the self-weight and superimposed surface dead and live loads acting on the area ADEF are omitted from V_u .

Computation of Unbalanced Moment at Critical Section

pcaslab

The factored unbalanced moment used for shear transfer, M_{unbal} , by default is computed as the sum of the joint moments to the left and right, taken to the centroidal axis of the critical section.

Computation of Shear Stresses at Critical Section

pcaslab

The punching shear stress printed by the program is based on the following:³⁸

³⁷ ACI 318-99, 8.11.8; ACI 318-02, 8.11.8

³⁸ ACI 318-99, 11.12.6.2; ACI 318-02, 11.12.6.2; CSA A23.3-94, 13.4.5

$$v_u = \frac{V_u}{A_c}, \quad \text{Eq. 2-40}$$

where:

V_u = factored shear force on the critical section described above,
 A_c = area of concrete, including beam if any, resisting shear transfer.

Under conditions of combined shear, V_u , and an unbalanced moment, M_{unbal} , $\gamma_v M_{\text{unbal}}$ is assumed to be transferred by eccentricity of shear about the centroidal axis of the critical section. The shear stresses printed by the program for this condition correspond to:³⁹

$$v_{AB} = \frac{V_u}{A_c} + \frac{\gamma_v M_{\text{unbal}} c_{AB}}{J_c}, \quad \text{Eq. 2-41}$$

$$v_{CD} = \frac{V_u}{A_c} - \frac{\gamma_v M_{\text{unbal}} c_{CD}}{J_c}, \quad \text{Eq. 2-42}$$

where:

M_{unbal} = factored unbalanced moment transferred directly from slab to column, as described above,

γ_v = $(1 - \gamma_f)$, Eq. 2-43

is a fraction of unbalanced moment considered transferred by the eccentricity of shear about the centroid of the assumed critical section,⁴⁰

c = distance from centroid of critical section to the face of section where stress is being computed,

J_c = property of the assumed critical section analogous to polar moment of inertia.

Factor γ_f in . 2-43 is calculated as

$$\gamma_f = \frac{1}{1 + (2/3)\sqrt{b_1/b_2}}, \quad \text{Eq. 2-44}$$

where:

³⁹ ACI 318-99, 11.12.6.2; ACI 318-02, 11.12.6.2; CSA A23.3-94, 13.4.5.5

⁴⁰ ACI 318-99, 11.12.6.2; ACI 318-02, 11.12.6.2; CSA A23.3-94, Eq. 13-8

b_1 = width of critical section in the direction of analysis,
 b_2 = width of the critical section in the transverse direction.

pcaSlab calculates v_u as the absolute maximum of v_{AB} and v_{CD} . Local effects of concentrated loads are not computed by pcaSlab and must be calculated manually.

Shear Resistance at Corner Columns

pcaSlab

For CSA A23.3-94 Code the program performs one-way shear resistance check in the vicinity of corner columns. A critical shear section is located $d/2$ from the column corner. The minimum length section is selected using an optimization algorithm which analyzes sections at different angles. The extension to the cantilevered portion is considered by a length not to exceed effective slab thickness d . For slabs with edge beams or drop panels the check including the contribution of these components should be preformed manually.

Shear Analysis of Longitudinal Beams

pcaSlab | pcaBeam

When longitudinal beams are present in a span, pcaSlab will compute the shear reinforcement requirements for the beams. Table “Longitudinal Beam Shear Reinforcement Required” in the program output provides values of V_u , V_c , and A_v/s for selected segment locations of each span. Segment lengths are chosen not to exceed the beam section depth. The beginning of first segment and the end of last segment correspond to the locations of critical sections on the left and right support respectively. The critical sections are located at a distance d , the effective beam depth, away from the column face at both the left and the right ends of the beam. However, if concentrated loads are present within distance d from the column face, critical section is selected at the column face.

V_u is computed from the load acting over the entire width of the design strip. The program makes no distinction between shallow beams ($\alpha_1 l_2 / l_1$ less than 1) and deeper beams ($\alpha_1 l_2 / l_1$ greater than 1).

For ACI 318 Code the shear strength provided by concrete, V_c , is computed by:⁴¹

$$V_c = 2\sqrt{f'_c} b_w d. \quad \text{Eq. 2-45}$$

In CSA design, for beams without minimum stirrup reinforcement and greater than 300 mm deep, V_c is calculated from the following equation:

⁴¹ ACI 318-99, 11.3.1.1; ACI 318-02, 11.3.1.1; CSA A23.3-94, 11.3.5.1

$$V_c = \left(\frac{260}{1000 + d} \right) \lambda \phi_c \sqrt{f'_c} b_w d \geq 0.10 \lambda \phi_c \sqrt{f'_c} b_w d. \quad \text{Eq. 2-46}$$

When $V_u > \phi V_c / 2$, the beam must be provided with at least a minimum shear reinforcement of:⁴²

$$\frac{A_v}{s} = \frac{50b_w}{f_{yv}}, \quad \text{Eq. 2-47}$$

where

- A_v = area of two legs of stirrups,
- s = stirrups spacing,
- b_w = longitudinal beam width,
- f_{yv} = yield strength of the shear reinforcement.

When $V_u > \phi V_c$, shear reinforcement must be provided so that:

$$\frac{A_v}{s} = \frac{V_u - \phi V_c}{\phi f_{yv} d}, \quad \text{Eq. 2-48}$$

where:

- V_u = factored shear force at the section being considered
- d = effective depth of the beam at the same location

For the ACI 318-99 Code the strength reduction factor for shear calculations is specified as $\phi=0.85$. For the ACI 318-02 Code the strength reduction factor for shear calculations is equal $\phi=0.75$.

When V_u exceeds $\phi 5V_c$, the beam section dimensions must be increased or a higher concrete strength must be provided.⁴³ When $V_u \leq \phi 10 \sqrt{f'_c} b_w d$, the spacing is computed as:

$$s = \frac{1}{\frac{A_v}{s}} A_{sb}, \quad \text{Eq. 2-49}$$

where

⁴² ACI 318-99, 11.5.5.2; ACI 318-02, 11.5.5.2; CSA A23.3-94, 11.2.8.4

⁴³ ACI 318-99, 11.5.6.9; ACI 318-02, 11.5.6.9; CSA A23.3-94, 11.3.4

A_{sb} = total bar area of the two legged stirrup.

The maximum stirrup spacing must not exceed $d/2$ nor 24 in when $V_u \leq \phi 6 \sqrt{f'_c} b_w d$. When $V_u > \phi 6 \sqrt{f'_c} b_w d$, the maximum stirrup spacing must be reduced by half, to $d/4$ or 12 in.⁴⁴ When $V_u > \phi 10 \sqrt{f'_c} b_w d$, the beam section dimensions must be increased or a higher concrete strength must be provided.

When no ribs are present the program proportions the slab and beam share of one-way shear according to the following ratios:

$$\alpha_1 l_2 / l_1, \quad 1 - \alpha_1 l_2 / l_1, \quad \text{Eq. 2-50}$$

When ribs are present (waffle) the program proportions the slab and beam share of one-way shear according to the following ratios of cross-section areas:

$$\frac{A_{ribs}}{A_{ribs} + A_{beam}}, \quad \frac{A_{beam}}{A_{ribs} + A_{beam}}. \quad \text{Eq. 2-51}$$

Torsion and Shear

Torsion analysis can be engaged for beam and one way systems using the **Torsion Analysis and Design** check box located on the **Solve Options** tab in the **Input | General Information** dialog box.

As far as torsional analysis is concerned, it is assumed that columns provide perfectly rigid supports so there is no transfer of torsional moments between spans. Within a span, torsional moments are considered only if a longitudinal beam is present. Torsion can be induced by concentrated and redistributed torsional loads and also, in the case of a beam with unsymmetrical cross sections, by self weight and area loads. A T-section with different flange widths is an example of a cross section which is not symmetrical. It can be obtained if a beam and a slab with different left and right widths are combined in the same span. However, in order for a flange to be considered in the torsional analysis its thickness has to be greater than twice the cover. If a flange is wider than the effective width then only the effective width is taken into account.

The design for torsion is based on a thin-walled tube, space truss analogy. For the Canadian code the simplified method is used. Program allows both equilibrium and compatibility torsion conditions. In the equilibrium mode, which is assumed

⁴⁴ ACI 318-99, 11.5.4; ACI 318-02, 11.5.4; CSA A23.3-94, 11.2.11

by default, unreduced total value of the torsional design moment is used in the design. In the compatibility mode⁴⁵, factored torsional moments that exceed cracking moment T_{cr} ($T_{cr} = 4 \Phi \sqrt{f'_c} \frac{A_{cp}}{P_{cp}}$, Eq. 2-52) ($0.67 T_{cr}$ for CSA) are

reduced to the value of T_{cr} ($0.67 T_{cr}$ for CSA). However, it is user's responsibility to determine which mode is appropriate and pcASlab does not perform any internal force redistribution if compatibility torsion is selected.

If torsion analysis is engaged then both torsion and shear actions contribute to the amount of required transverse (stirrup) reinforcement. However, additional longitudinal bars distributed along the perimeter of a cross-section are also required to provide torsional resistance.

For torsion design a span is divided into segments in the same way as for shear design. Governing values within a segment are used to design the whole segment. For stirrups, the governing values of torsional moment and shear force (acting simultaneously) will be these that produce the highest intensity of required stirrup area intensity. On the other hand, the required area of longitudinal bars depends only on the torsional moment so the highest absolute value of torsional moment will govern. Please note that since stirrup area depends both on shear and torsion whereas longitudinal bar area depends only on torsion so the governing values for stirrups and longitudinal bars can occur at different locations within a segment and for different load combinations. These governing values along with their location and associated load combination are output in the design results report.

Effect of torsion within a segment will be neglected if the factored torsional moment, T_u , at every segment location is less than one fourth of the torsion cracking moment, T_{cr} , which equals

$$T_{cr} = 4 \Phi \sqrt{f'_c} \frac{A_{cp}}{P_{cp}}, \quad \text{Eq. 2-52}$$

for ACI code and

$$T_{cr} = 0.4 \Phi_c \lambda \sqrt{f'_c} \frac{A_{cp}}{P_{cp}}, \quad \text{Eq. 2-53}$$

⁴⁵ ACI 318-99, 11.6.2.2; ACI 318-02, 11.6.2.2; CSA A23.3-94, 11.2.9.2

for CSA standard where A_{cp} denotes the area enclosed by outside perimeter of concrete section and p_{cp} equals the outside perimeter of concrete section. To be adequate for torsion design, a section has to be proportioned in such a way that combined shear stress due to shear and torsion does not exceed the limit value specified by the code. In ACI code this condition reads as:

$$\sqrt{\left(\frac{V_u}{b_w d}\right)^2 + \left(\frac{T_u p_h}{1.7 A_{oh}^2}\right)^2} \leq \Phi \left(\frac{V_c}{b_w d} + 8\sqrt{f'_c} \right), \quad \text{Eq. 2-54}$$

The simplified method of CSA standard defines this relation as:

$$\frac{V_u}{b_w d} + \frac{T_u p_h}{A_{oh}^2} \leq 0.25 \Phi_c f'_c. \quad \text{Eq. 2-55}$$

In both relations, A_{oh} is the area enclosed by centerline of the outermost closed transverse reinforcement and p_h is the perimeter of that area. By default, flanges do not contribute to A_{oh} and p_h . For sections with flanges, flanges will only be taken into account for A_{oh} and p_h if the option to include stirrups in flanges is engaged in the torsion design. In the program output, the combined stress (left hand side of the above inequalities) is denoted as v_f and the limit value as Φs_{vt} .

The required intensity of stirrup area to provide required torsional resistance is calculated from the following formula:

$$\frac{A_t}{s} = \frac{T_u}{2 \Phi A_o f_{yv}}, \quad \text{Eq. 2-56}$$

where the gross area enclosed by the shear path, A_o , is taken as $0.85 A_{oh}$. A_t/s is the quantity per stirrup leg so the total requirement for stirrup intensity combining shear and torsion equals

$$\frac{A_{v+2t}}{s} = \frac{A_v}{s} + 2 \frac{A_t}{s}. \quad \text{Eq. 2-57}$$

This value cannot be taken less than minimum stirrup area required by the codes. The minimum code requirements can be written in the following form:

$$\frac{A_{v+2t}}{s} \geq \begin{cases} \max(0.75\sqrt{f'_c}, 50) \cdot \frac{b_w}{f_{yv}}, & \text{for ACI 318-02,} \\ 50 \frac{b_w}{f_{yv}}, & \text{for ACI 318-99,} \\ 0.06\sqrt{f'_c} \frac{b_w}{f_{yv}}, & \text{for CSA A23.3-94.} \end{cases} \quad \text{Eq. 2-58}$$

In addition to stirrup spacing requirement defined for shear, program imposes one more torsion specific requirement for all codes which limits the spacing to the smaller of $p_h/8$ and 12 in [300 mm]. Based on the total required stirrup area intensity and spacing requirements, program attempts to select stirrups taking also into account that if stirrups with more than two legs have to be used than the area of an outer leg must not be less than A_t .

The area of additional longitudinal reinforcement, A_l , is calculated from

$$A_l = \frac{T_u p_h}{2 \Phi A_o f_{yl}}. \quad \text{Eq. 2-59}$$

For ACI code it is also checked against the following minimum value:

$$A_{l,\min} = \frac{5\sqrt{f'_c} A_{cp}}{f_{yl}} - \left(\frac{A_t}{s}\right) p_h \frac{f_{yv}}{f_{yl}}, \quad \text{Eq. 2-60}$$

where A_t/s is calculated from Eq. 2-54 but is not taken less than $25b_w/f_{yv}$.

Longitudinal bars are selected in such a way that their area is not less than $A_l \geq A_{l,\min}$ and that number of longitudinal bars in a section is enough to provide a bar in every corner of a stirrup and preserve spacing between bars not higher than 12 in [300 mm]. Also, bar sizes are selected not to have diameter less than No. 3 bar and not less than 1/24 of stirrup spacing for ACI codes and 1/16 for CSA standard.

In the investigation mode when transverse and longitudinal reinforcement is input by the user, program checks the combined shear and torsional capacity of the system in terms of required and provided reinforcement area i.e. the provided area of reinforcement is compared with to the area of reinforcement required to resist applied loads. This is different approach than for flexure and shear actions with no

coupling where internal design forces are compared to capacity. In case where torsion and shear stirrup requirements are combined, the approach of comparing total reinforcement area is more convenient since it does not require dividing stirrup area into a part that resists torsion only and a part resisting shear only. For consistency, longitudinal reinforcement is also checked in terms of provided and required area. Other requirements like bar or stirrup spacing, number of longitudinal bars, area of stirrup outer leg, and combined stresses in concrete due to shear and torsion are checked also. Exceeded capacity and other conditions are flagged in the **Design Results** section of the report.

Area of Reinforcement

The program calculates the required area of reinforcement (top and bottom) based on the values of bending moment envelope within the clear span. For rectangular sections with no compression reinforcement, the design flexural strength of the column strip, middle strip and beam must equal the factored design moment:

$$M_u = \phi f_y A_s \left(d - \frac{A_s f_y}{2(0.85 f'_c b)} \right). \quad \text{Eq. 2-61}$$

The reinforcement can therefore be computed from:

$$A_s = \frac{0.85 f'_c b}{f_y} \left(d - \sqrt{d^2 - \frac{2M_u}{\phi 0.85 f'_c b}} \right). \quad \text{Eq. 2-62}$$

For CSA A23.3-94

$$M_r = \phi_s f_y A_s \left(d - \frac{\phi_s A_s f_y}{2(\alpha_1 \phi_c f'_c b)} \right). \quad \text{Eq. 2-63}$$

The effective depth of the section is taken as the overall section depth minus the distance from the extreme tension fiber to the tension reinforcement centroid. The column strip depth may include all or part of the drop panel depth. The drop depth will not be included in the effective depth of the column strip when the drop does not extend at least one-sixth the center-to-center span length in all directions, or when the drop depth below the slab is less than one-quarter the slab depth. If the drop does extend at least one-sixth the center-to-center span length and the drop depth is greater than one-quarter the distance from the edge of the drop panel to the face of the column or column capital, the excess depth will not be included in

the column strip effective depth. If the drop width is less than the column strip width, the drop width will be used in the computation of the required reinforcement.

For the ACI 318-99 Code the strength reduction factor for flexure calculations is specified as $\phi=0.90$.⁴⁶ For the ACI 318-02 Code the strength reduction factor for tension-controlled sections ($\varepsilon_t \geq 0.005$) is equal $\phi=0.90$. For transition sections ($0.002 \leq \varepsilon_t \leq 0.005$) the strength reduction factor is specified by the formula:

$$\phi = 0.48 + 83 \cdot \varepsilon_t . \quad \text{Eq. 2-64}$$

ACI 318-02 Code specifies the strength reduction factor for compression controlled sections ($\varepsilon_t < 0.002$) as equal $\phi=0.65$. The reduction factors for transition or compression controlled sections have application primarily in investigation mode of the program. In design mode the program performs the calculations assuming tension controlled section or section with compressive reinforcement (if enabled).

The ACI 318-99 Code requires keeping the steel ratio below 75 percent ρ_b , where:⁴⁷

$$\rho_b = 0.85\beta_1 \frac{f'_c}{f_y} \frac{87}{87 + f_y} , \quad \text{Eq. 2-65}$$

where

$$\beta_1 = \begin{cases} 0.85 & \text{for } f'_c \leq 4 \text{ ksi,} \\ 0.65 & \text{for } f'_c \geq 4 \text{ ksi,} \\ 1.05 - 0.05f'_c & \text{for } 4 \text{ ksi} < f'_c < 8 \text{ ksi.} \end{cases}$$

For CSA code the value of ρ_b is calculated as follows:

$$\rho_b = \alpha_1\beta_1 \frac{f'_c}{f_y} \frac{700}{700 + f_y} , \quad \text{Eq. 2-66}$$

where

⁴⁶ ACI 318-99, 9.3.2

⁴⁷ ACI 318-99, 8.4.3; CSA A23.3-94, 10.5.2

$$\alpha_1 = 0.85 - 0.0015 f'_c \geq 0.67,$$

$$\beta_1 = 0.97 - 0.0025 f'_c \geq 0.67.$$

The ACI 318-02 Code controls the amount of reinforcement by limiting the value of net tensile strain ($\epsilon_t \geq 0.005$)⁴⁸ (tensioned controlled section). From this condition the equivalent maximum reinforcement ratio for rectangular section can be written as:

$$\rho_{\max} = \frac{0.003}{0.003 + 0.005} \frac{0.85\beta_1 f'_c}{f_y} \quad \text{Eq. 2-67}$$

If the calculated reinforcement exceeds the maximum allowed, a message will appear in the output. In such cases, it is recommended that the engineer review the slab thickness to ensure a more satisfactory design. If compression reinforcement calculations are enabled, pcaSlab will attempt to add compression reinforcement to the section. The program is capable to design compressive reinforcement for any design strip (column, middle, and beam) including also unbalanced moment strip.

The amount of reinforcement provided will not be less than the code prescribed minimum. For the ACI 318 Code, the minimum ratio of reinforcement area to the gross sectional area of the slab strip using Grade 60 reinforcement is taken as 0.0018. When reinforcement yield strength exceeds 60 ksi, the minimum ratio is set to $0.0015 \cdot 60 / f_y$. For reinforcement with yield strength less than 60 ksi, the minimum ratio is set to 0.0020. In no case will this ratio be less than 0.0014 (See Table 2-6)⁴⁹. The CSA Standard requires a minimum ratio of slab reinforcement area to gross sectional area of the slab strip equal to 0.002 for all grades of reinforcement⁵⁰.

f_y (ksi)	A_s/A_g
< 60	0.0020
≥ 60	$\frac{0.0018 \times 60}{f_y} \geq 0.0014$

Table 2-6. Minimum Ratios of Reinforcement to Gross Concrete Area

⁴⁸ ACI 318-02, 10.3.5

⁴⁹ ACI 318-99, 7.12.2.1; ACI 318-02, 7.12.2.1

⁵⁰ CSA A23.3-94, 7.8.1

According to ACI code for beams and positive moment regions of waffle slabs, minimum reinforcement provided will not be less than:⁵¹

$$A_{s,\min} = \frac{3\sqrt{f'_c}}{f_y} b_w d \quad \text{Eq. 2-68}$$

and not less than $200b_w d / f_y$.

Similar equation prescribed by CSA code has the form⁵²:

$$A_{s,\min} = \frac{0.2\sqrt{f'_c}}{f_y} b_w h \quad \text{Eq. 2-69}$$

In calculating required amounts of negative support steel for CSA A23.3-94 Code, the program performs the adjustment for banded and distributed reinforcement. The code requires concentrating one-third of the negative reinforcement at interior supports in the band region extending $1.5 h_s$ from the sides of the columns. At exterior supports the total negative reinforcement is placed in the band region. The remaining portion of the negative reinforcement needs to be placed in the distributed strip. The reinforcement in banded and distributed strip is also checked for compliance with the minimum reinforcement requirement.

Reinforcement Selection

The default minimum clear spacing of reinforcement considered in pcaSlab is the Code prescribed minima for both slabs and beams of one bar diameter, d_b , or 1 in.⁵³ The user may select clear spacing greater than the default value.

For two-way systems, the maximum spacing of reinforcement is kept at two times the slab thickness for the ACI code⁵⁴ and three times the slab thickness for the CSA code⁵⁵ but no more than 18 in. or 500 mm respectively. For waffle slabs the limit is increased to 5 times the slab thickness⁵⁶. When calculating negative support reinforcement for the CSA code⁵⁷, the program assumes that banded

⁵¹ ACI 318-99, 10.5.1; ACI 318-02, 10.5.1

⁵² CSA A23.3-94, 10.5.1.2(b)

⁵³ ACI 318-99, 7.6.1; ACI 318-02, 7.6.1

⁵⁴ ACI 318-99, 13.3.2; ACI 318-02, 13.3.2

⁵⁵ CSA A23.3-94, 13.11.3(b)

⁵⁶ ACI 318-02, 7.12.2.2; ACI 318-02, 7.12.2.2; CSA A23.3-94, 7.8.3

⁵⁷ CSA A23.3-94, 13.11.3(a)

reinforcement over supports is spaced at a maximum of $1.5 h_s$ and no more than 250 mm.

In case of beams and one-way systems the maximum spacing of reinforcement is selected so that the crack control requirements of the ACI and the CSA codes⁵⁸ are met.

An iterative process is performed to determine the number of bars and bar size. The initial number of bars is determined by dividing the total reinforcement area required, A_s , by the area of one bar, A_{sb} , of the input minimum bar size. Next, the spacing is determined. If the minimum spacing limitations are violated, the bar size is increased and the iterative process continues until all bars sizes have been checked. If the maximum spacing limitations are not met, the number of bars required to satisfy these limitations is computed and the iteration process terminates.

For beams, layered reinforcement is provided if sufficient beam width is not available. pcaSlab assumes a 1.5 in cover to stirrup for width calculations. pcaSlab also assumes that the longitudinal bar makes contact at the middle of the stirrup bend where the minimum inside diameter of the bend is $4d_b$. Therefore, an additional width is added to the cover for longitudinal bars less than #14 (an SI N-45) in size (Figure 2-20 – Figure 2-21). This additional width due to the bend, w_{bend} , is equal to:

$$w_{bend} = 0.293 \left(1.0 - \frac{d_b}{2} \right), \quad \text{Eq. 2-70}$$

where

d_b = bar diameter of the longitudinal bar.

The clear distance between layers is assumed 1.0 in. Hooks and bends are not included in bar length figures.

⁵⁸ ACI 318-99, 10.6.4; ACI 318-02, 10.6.4; CSA A23.3-94, 10.6.1

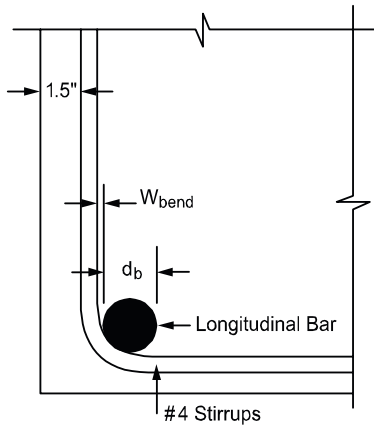

Figure 2-20 Width due to strip bend

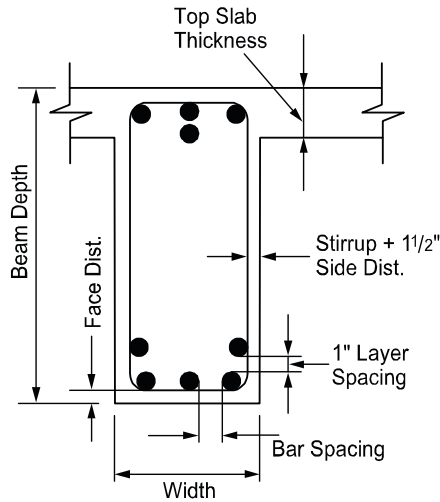

Figure 2-21 Detail reinforcement in longitudinal beams

Bar-length computations are performed for two-way slabs and longitudinal beams. For top reinforcement at the supports, the length for long bars is given by:

$$l_{\text{long}} = \max \begin{cases} \max(l_{50\%}) + l_{d,\text{long}}, \\ \max(l_{\text{pi}}) + \max\{d, 12d_b, l_n / 16\}, \\ l_{\text{fos}} + l_{\text{cr, long}}, \end{cases} \quad \text{Eq. 2-71}$$

and the length for short bars is given by:

$$l_{\text{short}} = \max \begin{cases} \max(l_{50\%}) + \max\{d, 12d_b\}, \\ l_{\text{fos}} + \max\{l_{d,\text{short}}, l_{\text{cr, short}}\} \end{cases} \quad \text{Eq. 2-72}$$

where:

$\max(l_{50\%})$	=	maximum distance to the points of 50% demand,
$\max(l_{\text{pi}})$	=	maximum distance to the points of inflection (P.I.),
l_d	=	bar development length ⁵⁹ ,
d	=	effective depth,
d_b	=	bar diameter,
l_n	=	clear span length,
l_{fos}	=	distance to the face of support (column),
l_{cr}	=	minimum code prescribed extension.

These bar lengths are then compared and adjusted if necessary to the minimum requirements specified by the code.⁶⁰ Additionally the program may select continuous top bars in those spans where steel is required by calculation in mid-span at top.

If the computed bar lengths overlap, it is recommended that such reinforcement be run continuously. The printed bar lengths do not include hooks or portions of bars bent down into spandrel beams or other bar-bend configurations.

The selection of bar lengths for positive reinforcement for flat plates, flat slabs, and beam-supported slabs, is based strictly on the minimum values of the Code. For waffle slabs, however, the positive reinforcement selection is based on an additional assumption of two bars per joist. For purposes of output, one bar is treated as a long bar and the other as a short bar.

The development length depends on the following factors: concrete cover, minimum transverse reinforcement, special transverse reinforcement, layer

⁵⁹ ACI 318-99, Chapter 12; ACI 318-02, Chapter 12; CSA A23.3-94, Clause 12.2

⁶⁰ ACI 318-99, Figure 13.3.8; ACI 318-02, Figure 13.3.8; CSA A23.3-94, Figure 13.1

location bar size and bar clear spacing. The computation of tension development lengths in terms of d_b is given by the general expression:

$$\frac{l_d}{d_b} = \frac{3}{40} \frac{f_y}{\sqrt{f'_c}} \frac{\alpha\beta\gamma\lambda}{\left(\frac{c+k_{tr}}{d_b}\right)}, \quad \text{Eq. 2-73}$$

where:

- α = reinforcement location factor (1 or 1.3),
- β = coating factor (1.2 or 1.5),
- γ = reinforcement size factor (1 or 0.8),
- λ = light weight aggregate concrete factor (1 or 1.3),
- K_{tr} = transverse reinforcement index,
- C = spacing or cover dimension.

Additional Reinforcement at Support

pcaSlab computes the fraction of the unbalanced moment, $\gamma_f M_u$, that must be transferred by flexure within an effective slab width (a band) equal to the column width plus one and one-half the slab or drop panel depth ($1.5h$) on either side of the column where:⁶¹

$$\gamma_f = \frac{1}{1 + \frac{2}{3} \sqrt{b_1/b_2}} \quad \text{Eq. 2-74}$$

The amount of reinforcement required to resist this moment is computed. The amount of reinforcement already provided for negative flexure is then computed from the bar schedule (i.e. the number of bars that fall within the effective slab width multiplied by the area of each bar). If the reinforcement area provided for flexure is greater than or equal to the reinforcement requirements to resist moment transfer by flexure, no additional reinforcement is provided, and the number of additional bars will be set to 0. If the amount of reinforcement provided for flexure is less than that required for moment transfer by flexure, additional reinforcement is required. The additional reinforcement is the difference between that required for unbalanced moment transfer by flexure and that provided for design bending moment in the slab, and it is selected based on the bar size already provided at the support.

⁶¹ ACI 318-99, 13.5.3.2; ACI 318-02, 13.5.3.2; CSA A23.3-94, 13.11.2 and 13.4.5.3

It should be noted that the ACI Code⁶² requires either concentration of reinforcement over column beam joint by closer spacing, or additional reinforcement, to resist the transfer moment within the effective slab width. Thus for the ACI code, pcaSlab only provides additional reinforcement and does not concentrate existing reinforcement. The CSA Code, however, requires concentration of column strip reinforcement within the bands over supports⁶³, which is done in pcaSlab first and then additional reinforcement is provided, if necessary.

Integrity Reinforcement

pca slab

For the ACI Code, all bottom bars in the column strip should extend continuously (or with splices) in the entire span and at least two of these bars should pass within the column core and should be anchored at exterior supports⁶⁴.

For the CSA Code, the program performs calculation of the amount of integrity reinforcement at slab column connections. The integrity reinforcement is required for slabs without beams. Integrity reinforcement is not required if there are beams containing shear reinforcement in all spans framing into the column. Otherwise, the sum of all bottom reinforcement connecting the slab to the column on all faces of the periphery should meet the condition:

$$\sum A_{sb} \geq \frac{2V_{se}}{f_y} \quad \text{Eq. 2-75}$$

and should consist of at least two bars⁶⁵.

Corner Reinforcement

pca slab

The program performs calculation of the amount of reinforcement in exterior corners of slabs with stiff edge beams (α greater than 1.0)⁶⁶. This reinforcement is required within a region equal to 1/5 of the shorter span. The amount of corner reinforcement is calculated from the moment per unit width intensity corresponding to the maximum positive moment in span. The Code requires the corner reinforcement to be placed at top and bottom of the slab in bands parallel to the sides of the slab edges.

⁶² ACI 318-99, 13.5.3.4, ACI 318-02, 13.5.3.4

⁶³ CSA A23.3-94, 13.12.2.1 and 13.12.2.2

⁶⁴ ACI 318-99, 13.3.8.5, ACI 318-02, 13.3.8.5

⁶⁵ CSA A23.3-94, 13.11.5.1 and 13.11.5.2

⁶⁶ ACI 318-99, 13.3.6; ACI 318-02, 13.3.6; CSA A23.3-94, 13.13.5

Deflections

Deflections of two-ways systems

Calculation of deflections of reinforced concrete two-way slabs is complicated by a large number of significant parameters such as: the aspect ratio of the panels, the vertical and torsional deflection of supporting beams, the stiffening effect of drop panels and column capitals, cracking, and the time-dependent nature of the material response. Based on studies (Ref. [22–24]), an approximate method consistent with the equivalent frame method was developed (Ref. [25]) to estimate the column and middle strip deflections.

Calculation of the midspan deflection of the column strip or the middle strip is based on the M/EI ratio of the strip to that of the full-width panel:

$$a_{f,strip} = a_{f,ref} \frac{M_{strip}}{M_{frame}} \frac{E_c I_{frame}}{E_c I_{strip}}, \quad \text{Eq. 2-76}$$

where $a_{f,ref}$ is taken from the equivalent frame analysis assuming gross section (uncracked) or effective (cracked) section properties.

The ratio (M_{strip}/M_{frame}) can be considered as a lateral distribution factor, LDF. The lateral distribution factor, LDF, at an exterior negative moment region is:

$$LDF_{neg,ext} = 100 - 10 \beta_t + 12 \beta_t \left(\alpha_1 \frac{l_2}{l_1} \right) \left(1 - \frac{l_2}{l_1} \right). \quad \text{Eq. 2-77}$$

The LDF at an interior negative moment region is:

$$LDF_{neg,int} = 75 - 30 \left(\alpha_1 \frac{l_2}{l_1} \right) \left(1 - \frac{l_2}{l_1} \right). \quad \text{Eq. 2-78}$$

The LDF at a positive moment region is:

$$LDF_{pos} = 60 + 30 \left(\alpha_1 \frac{l_2}{l_1} \right) \left(1.5 - \frac{l_2}{l_1} \right), \quad \text{Eq. 2-79}$$

where:

α_1 = the ratio of flexure stiffness of a beam section to the flexural stiffness of a width of slab bounded laterally by centerlines of adjacent panels on either side of the beam,

β_t = ratio of torsional stiffness of an edge beam section to the flexural stiffness of a width of slab equal to the span length of the beam, center-to-center of the supports (see Eq. 2-27).

When $\alpha_1 l_2 / l_1$ is greater than 1.0, $\alpha_1 l_2 / l_1$ will be set equal to 1.0.

The column and middle strip LDF's can be computed by:

$$\text{LDF}_c = \frac{\text{LDF}_{\text{pos}} + \frac{\text{LDF}_{\text{neg},l} + \text{LDF}_{\text{neg},r}}{2}}{2}, \quad \text{Eq. 2-80}$$

$$\text{LDF}_m = 100 - \text{LDF}_c, \quad \text{Eq. 2-81}$$

where:

$\text{LDF}_{\text{neg},l}$ = LDF for the negative moment region at the left end of the span
 $\text{LDF}_{\text{neg},r}$ = LDF for the negative moment region at the right end of the span

The deflections should be used in conjunction with the deflections obtained from an analysis in the transverse direction. For square panels ($l_1 = l_2$), the midpanel deflection is obtained by . 2-82 as shown in Figure 2-22:

$$a = a_{cy} + a_{mx} = a_{cx} + a_{my}. \quad \text{Eq. 2-82}$$

For rectangular panels, ($l_1 \neq l_2$), the mid panel deflection is obtained by . 2-83:

$$a = \frac{(a_{cy} + a_{mx}) + (a_{my} + a_{cx})}{2}. \quad \text{Eq. 2-83}$$

When calculating the deflections for effective (cracked) section properties, the equivalent frame solution is obtained for two load levels:

- dead load only,
- dead load and live load combined.

The effective section properties are assumed corresponding to the load level.

Deflections of beam and one-way systems

Continuous beam and one-way slab deflections are computed based on simply supported deflections less the deflection due to the end support rotations. The effects of support settlement or shear deformations are not considered. When segmental moments and shears are requested, the segmental deflections printed are

at 20 equally spaced sections along the span. Concentrated loads occurring at other locations will give rise to larger deflections. These must be checked manually.

Cracking

If gross section properties option is selected for deflection calculations in the input, the deflection calculations will be based on the gross section I_g . If cracked section properties option is selected the effect of cracking on the deflection calculations is considered. The effect of cracking in slabs, as in beams, is a reduction in the flexural stiffness. The effect of cracking is generally an increase in deflections, although the tensile concrete between cracks continues to have a stiffening influence. A detailed review of several methods of deflection analyses can be found in Ref. [24].

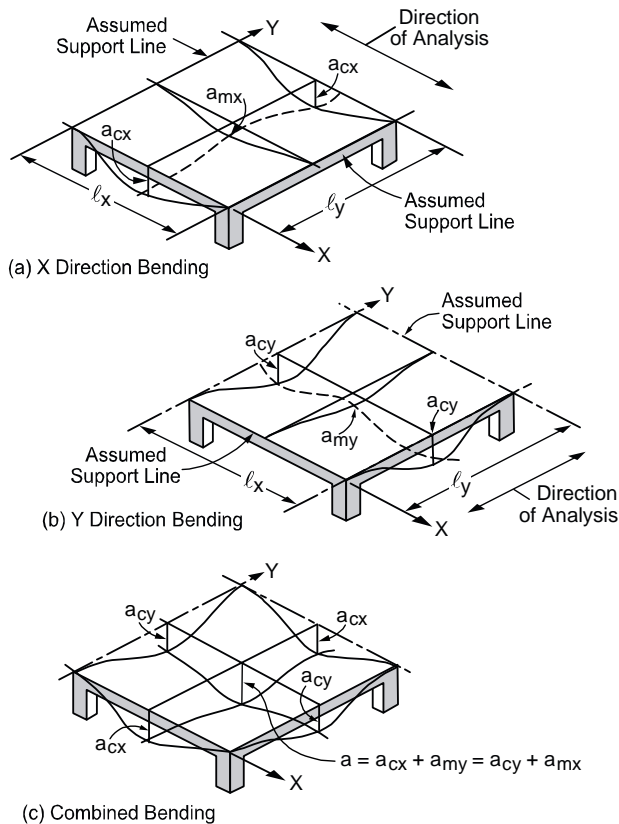

Figure 2-22 Deflection computation for a square panel

To apply the Code-specified effective moment of inertia to slab systems, a value of $I_{a,frame}$ is used instead. The value of $I_{a,frame}$ is given by:

$$I_{a,frame} = \beta I_e^+ + \frac{(1-\beta)(I_{e,l}^- + I_{e,r}^-)}{2}, \quad \text{Eq. 2-84}$$

where:

- I_e^+ = effective moment of inertia for the positive moment region,
- $I_{e,l}^-$ = effective moment of inertia for the negative moment region at the left support,
- $I_{e,r}^-$ = effective moment of inertia for the negative moment region at the right support,
- β = an empirical constant based on experimental data, whose value is less than 1.0.

For flat plates, flat slabs, and waffle slabs, the appropriate value of β appears to be 0.5. pcaSlab uses a value of 0.5 for flat plates, flat slabs, and waffle slab systems and 0.7 for beam-supported slabs.

The value of $I_{a,frame}$ for cantilever spans is given by:

$$I_{a,frame} = \beta I_{e,sup}^- + (1-\beta) I_{e,end}^-, \quad \text{Eq. 2-85}$$

where:

- $I_{e,end}^-$ = effective moment of inertia for the negative moment region at the cantilever end,
- $I_{e,sup}^-$ = effective moment of inertia for the negative moment region at support.

For flat plates, flat slabs, and waffle slabs, the appropriate value of β appears to be 1.0. pcaSlab uses a value of 1.0 for flat plates, flat slabs, waffle slabs, and beam-supported slabs.

The value of I_e corresponds to the effective moment of inertia as developed by Branson (Ref. [26]) and incorporated into the Code as follows:⁶⁷

$$I_e = \left(\frac{M_{cr}}{M_{max}} \right)^3 I_g + \left[1 - \left(\frac{M_{cr}}{M_{max}} \right)^3 \right] I_{cr} , \quad \text{Eq. 2-86}$$

where

- I_g = moment of inertia of the gross uncracked concrete section for the full width of the equivalent frame,
- I_{cr} = moment of inertia of the cracked transformed concrete section for the full width of the equivalent frame,
- M_{cr} = cracking moment for the full width of the equivalent frame,
- M_{max} = maximum bending moment for the full width of the equivalent frame at the load stage at which the deflection is computed.

It should be noted that the use of the full slab width in determining I_e in 2-86 is intended to average the effects of cracking of the column and middle strips.

Instantaneous Deflections

pcAslab|pcABeam

Two values of mid-span deflections are computed by the program for each span. The first corresponds to dead load on all spans, while the second corresponds to dead load plus live load on all spans. Note that the live load deflection is always computed as total load deflection minus the dead load deflection. This is consistent with the I_{eff} method outlined in the Code.

Long Time Deflections

pcAslab|pcABeam

Long term deflection calculations are beyond the scope of the program. Users need to calculate long term deflection manually. The total mid-panel deflection (including long-time effects) consists of the following:

$$a_{total} = a_e + a_{creep} + a_{sh} , \quad \text{Eq. 2-87}$$

where

- a_e = elastic deflection,
- a_{creep} = additional deflection due to creep,
- a_{sh} = additional deflection due to shrinkage,
- a_{total} = total deflection.

⁶⁷ ACI 318-99, 9.5.2.3; ACI 318-02, 9.5.2.3

Data reported in the literature, although limited in quantity, indicate that the additional deflection due to creep and shrinkage, $a_{\text{creep}} + a_{\text{sh}}$, may be as much as two to eight times the elastic deflection, a_e (Ref. [27-30, 43]). Such a factor times the dead load deflection may be used for an estimate of required slab camber.

For a crude approximation to a complex problem, the total instantaneous plus long-time deflections may be computed as three times the instantaneous deflections (Δ_i). This approximation results from conservative estimation of code specified⁶⁸ multiplier, λ , for additional long-term deflections caused by the sustained load. Assuming no tension reinforcement ($\rho' = 0$), the maximum value of the time-dependant factor ($\xi = 2$) and that all load is sustained, we arrive at total deflection

$$(1 + \lambda) \Delta_i = \left(1 + \frac{\xi}{1 + 50\rho'}\right) \Delta_i \leq 3\Delta_i. \quad \text{Eq. 2-88}$$

For a more detailed method of analysis of long-time deflection the user is referred to a study by Rangan (Ref. [30]).

Material Quantities

The program computes concrete and reinforcing steel quantities. The quantity of concrete is based on an average of the slab, drop, and beam sizes. The total quantity of reinforcing steel computed by the program corresponds to the actual bar sizes and lengths required by design. No allowance is made for bar hooks, anchorage embedment, and so forth. It should be noted that the quantity of reinforcement printed by the program pertains to bending in one direction only. In practice, the total amount of reinforcement for the structure should also include the quantities obtained for the appropriate transverse equivalent frames.

⁶⁸ ACI 318-99, 9.5.2.5; ACI 318-02, 9.5.2.5; CSA A.23.3-94, 9.8.2.5

References

- 1) Kripanarayanan, K. M., Analysis and Design of Slab Systems, Computer Program User's Manual, Portland Cement Association, SR184D, 1979.
- 2) Lee, B. H., Analysis and Design of Flat Plates, Flat Slabs, Waffle Slabs, and Continuous Frames, Portland Cement Association, 1972 (discontinued).
- 3) CRSI Handbook Based Upon the 1977 ACI Building Code and the 1980 Supplement, Concrete Reinforcing Steel Institute, Schaumburg, Illinois, 60195, 1982.
- 4) Sozen, M. A., and Siess, C. P., Reinforced Concrete Floor Slabs – Design Methods: Their Evolution and Comparison, Journal of the American Concrete Institute, Proceedings, V. 60, No. 8, August 1963, pp. 999-1028.
- 5) Hatcher, D. S., Sozen, M. A., and Siess, C. P., Test of a Reinforced Concrete Flat Plate, Proceedings of the American Society of Civil Engineers, V. 91, No. ST5, October 1965, pp. 205-231.
- 6) Guralnick, S. A., and LaFraugh, R. W., Laboratory Study of a Forty-Five-Foot Square Flat Plate Structure, Journal of the American Concrete Institute, Proceedings, V. 60, No. 9, September 1963, pp. 1107-1185.
- 7) Hatcher, D. S., Sozen, M. A., and Siess, C. P., Test of a Reinforced Concrete Flat Slab, Proceedings of the American Society of Civil Engineers, V. 95, No. ST6, June 1969, pp. 1051-1072.
- 8) Jirsa, J. O., Sozen, M. A., and Siess, C. P., Test of a Flat Slab Reinforced with Welded Wire Fabric, Proceedings of the American Society of Civil Engineers, V. 92, No. ST3, June 1966, pp. 199-224.
- 9) Gamble, W. L., Sozen, M. A., and Siess, C. P., Test of a Two-Way Reinforced Floor Slab, Proceedings of the American Society of Civil Engineers, V. 95, No. ST6, June, 1969, pp. 1073-1096.
- 10) Vanderbilt, M. D., Sozen, M. A., and Siess, C. P., Test of a Modified Reinforced Concrete Two-Way Slab, Proceedings of the American Society of Civil Engineers, V. 95, No. ST6, June, 1969, pp. 1097-1116.
- 11) Shewmaker, R. E., Xanthakis, M., and Sozen, M. A., Very Small Scale Reinforced Concrete Multi-Panel Flat Slabs, Civil Engineering Studies, Structural Research Series No. 265, University of Illinois, June 1963, 171 pp.

- 12) Xanthakis, M., and Sozen, M. A., An Experimental Study of Limit Design in Reinforced Concrete Flat Slabs, Civil Engineering Studies, Structural Research Series No. 277, University of Illinois, December 1963, 159 pp.
- 13) Nichols, J. R., Statistical Limitations Upon the Steel Requirement in Reinforced Concrete Flat Slab Floors, Transactions of the American Society of Civil Engineers, V. 77, 1914, pp. 1670-1726.
- 14) Gamble, W. L., Sozen, M. A., and Siess, C. P., Measured and Theoretical Bending Moments in Reinforced Concrete Floor Slabs, Civil Engineering Studies, Structural Research Series No. 246, University of Illinois, June 1962, 322 pp.
- 15) Jirsa, J. O., Sozen, M. A., and Siess, C. P., Pattern Loadings on Reinforced Concrete Floor Slabs, Proceedings of the American Society of Civil Engineers, V. 95, No. ST6, June, 1969, pp. 1117-1137.
- 16) Corley, W. G., Sozen, M. A., and Siess, C. P., The Equivalent Frame Analysis for Reinforced Concrete Slabs, Civil Engineering Studies, Structural Research Series No. 218, University of Illinois, June, 1961, 166 pp.
- 17) Jirsa, J. O., Sozen, M. A., and Siess, C. P., The Effects of Pattern Loadings on Reinforced Concrete Floor Slabs, Civil Engineering Studies Structural Research Series No. 269, University of Illinois, July 1963, 145 pp.
- 18) Corley, W. G., and Jirsa, J. O., Equivalent Frame Analysis for Slab Design, Journal of the American Concrete Institute, Proceedings, V. 67, No. 11, November 1970, pp. 875-884.
- 19) ETABS84, Computers and Structures, Inc., Berkeley, California, 1984.
- 20) ICES STRUDL II, Engineering User's Manual, Vols. 1 and 2, Department of Civil Engineering, Massachusetts Institute of Technology, R68-91/92, Cambridge, Massachusetts, 1968.
- 21) Hawkins, N. M., Shear Strength of Slabs with Moments Transferred to Columns, Special Publication SP42-35, American Concrete Institute, Detroit, Michigan, 1974, pp. 817-846.
- 22) ACI Committee 435, Subcommittee 7, Deflections of Continuous Concrete Beams, Journal of the American Concrete Institute, Proceedings V. 70, No. 12, December 1973, pp. 781-787.

- 23) Nilson, A. H., and Walters, D. B., Jr., Deflection of Two-Way Floor Systems by the Equivalent Frame Method, *Journal of the American Concrete Institute, Proceedings*, V. 72, No. 5, May, 1975, pp. 210-218.
- 24) ACI Committee 435, State-of-the-Art Report, Deflection of Two-Way Floor Systems, Special Publication SP43-3, American Concrete Institute, Detroit, Michigan, 1974.
- 25) Kripanarayanan, K. M., and Branson, D. E., Short-Time Deflections of Flat Plates, Flat Slabs and Two-Way Slabs, *Journal of the American Concrete Institute, Proceedings*, V. 73, No. 12, December 1976, pp. 686-690.
- 26) Branson, D. E., Instantaneous and Time-Dependent Deflections of Simple and Continuous Reinforced Concrete Beams, HPR Report No. 7, Pt. I, Alabama Highway Department in Cooperation with U.S. Department of Commerce, Bureau of Public Roads, August 1965.
- 27) Blakey, F. A., Deformations of an Experimental Lightweight Flat Plate Structure, Commonwealth Scientific and Industrial Research Organization (CSIRO), DBR Reprint No. 185, *Civil Engineering Transactions, Institute of Engineers*, V. CE 3, No. 1, Australia, March 1961.
- 28) Taylor, P. J., Long-Term Deflection Calculation Methods for Flat Plates, *Constructional Review*, V. 43, No. 2, Sydney, Australia, May 1970, pp. 68-74.
- 29) Heiman, J. L., A Comparison of Measured and Calculated Deflections of Flexural Members in Four Reinforced Concrete Buildings, Special Publication JSP43-21, American Concrete Institute, Detroit, Michigan, 1974.
- 30) Rangan, B. V., Prediction of Long-Term Deflections of Flat Plates and Slabs, *Journal of the American Concrete Institute, Proceedings*, V. 73, No. 4, April 1976, pp. 223-226.
- 31) Notes on ACI318-83 – Building Code Requirements for Reinforced Concrete with Design Applications, Portland Cement Association, 1984.
- 32) Elgabry, A. and Ghali, A., Proposed Revisions to Building Code Requirements for Reinforced Concrete (ACI 318-83) (Revised 1986), *ACI Structural Journal*, V. 86 No. 3, May-June 1989, pp. 327-328.
- 33) Notes on ACI318-95 – Building Code Requirements for Reinforced Concrete with Design Applications, Portland Cement Association PCA, 1996.
- 34) Manual of Standard Practice, Concrete Reinforcing Steel Institute CRSI, March 2001.

- 35) Reinforced Concrete, Mechanics & Design, 3rd ed. James McGregor, Prentice Hall, 1997.
- 36) Nilson, A. and Winter, G., Design of Concrete Structures, McGraw-Hill, New York, 1997.
- 37) Wang, C. K. and Salmon, C. G., "Reinforced Concrete Design" 6th Ed., Addison-Wesley, 1998.
- 38) A23.3-94 Design of Concrete Structures, Structures Design, Canadian Standards Association CSA, December 1994.
- 39) Concrete Design Handbook, Cement Association of Canada CAC, 2nd Ed., 2001.
- 40) Building Code Requirements for Structural Concrete (318-99) and Commentary (318R-99), American Concrete Institute ACI, Detroit, Michigan, June 1999.
- 41) Building Code Requirements for Structural Concrete (318-02) and Commentary (318R-02), American Concrete Institute ACI, Farmington Hills, Michigan, January 2002.
- 42) James R. Cagley, Changing from ACI 318-99 to ACI 318-02 What's New? Concrete International, June 2001.
- 43) Gilbert, R. I. and Guo X. H., "Time-Dependent Deflection and Deformation of Reinforced Concrete Flat Slabs – An Experimental Study", ACI Structural Journal, V. 102, May-June 2005, pp. 363-373.

Chapter 3

pcaSlab/pcaBeam Interface

User Interface Components



Check Boxes



A check box is a toggle used in a dialog box that enables or disables an option. To enable a check box, toggle the switch so that a ✓ sign is placed in the box. Removing the ✓ sign from the check box disables the command. Click once in the check box with the mouse to enable or disable the command or use the keyboard keys to tab to the check box and press the space bar to activate the option.

Checked Menu Commands



If the menu commands are checked with a ✓ sign on the left, the menu commands are enabled in the current project. To disable the command, single click the left mouse button on the command to clear the ✓ sign. For example, since the Toolbar and Status bar commands are checked in the image above, both the toolbar and status bar will appear in the main window of pcaSlab.

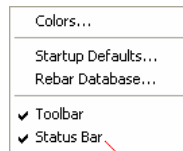
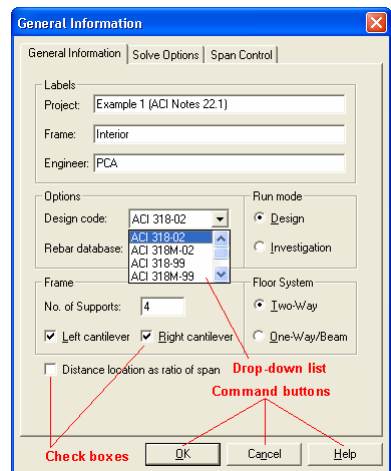

Checked Menu Command

Command Buttons



Command buttons such as OK and CANCEL buttons that are located inside dialog boxes, are labeled to do exactly what they say. After you have completed your input within a dialog box, click once with the left mouse button on Ok (all Windows) or press ALT + O with the keyboard keys (Windows 95, 98, ME) to save the changes. If, while working in a dialog box, you want to disregard the data

you have input, select CANCEL (all Windows) to exit and discard any new data. When using the keyboard keys select ALT + C (Windows 95, 98, ME).

Control Menu

pcaSlab|pcaBeam

Each window has a control menu located to the left of the title bar, in the upper left corner of the window. This menu contains commands that allow you to manipulate that particular window. To access the control menu using the mouse, click the left mouse button on pcaSlab icon in the upper left corner. To access the control menu using the keyboard, press CTRL + F6 to cycle through the windows until you reach the desired window and press ALT + - (hyphen).

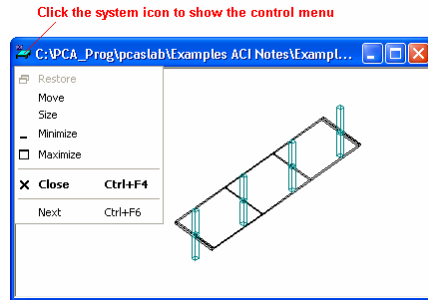

Dialog Boxes

pcaSlab|pcaBeam

Dialog boxes are used to request information or provide you with information. By selecting a command from a menu, a dialog box may be displayed requesting data to complete the command. A dialog box will follow any command that contains three trailing periods, "...". After entering the required data, press the OK button so that the data associated with that dialog box will be acted upon.

Drop-down List

pcaSlab|pcaBeam

A drop-down list is a list box that appears initially as a rectangular box with the current selection marked. To see a list of available choices, click the arrow to the right of the box or press ALT + DOWN ARROW to open the box. You can now select another item in a similar way as you would use a list box.

Usually there are some items in a drop-down list. You may click the left mouse button on the ▾ button on the right side of the list to extend the list. Then select the item you need by single clicking the left mouse button on the item. The selected item will appear in the text box on the top of the drop-down list. If there are too many items in a drop-down list, a vertical scroll bar will appear automatically so that you can use it to scroll up and down.

Drop-down Menu

A drop-down menu is the menu that is shown directly beneath the menu line when you click one of the menu items on the menu line using the left mouse button.

For example, the **File** menu appears directly beneath the "File" menu item when you click the "File" on the menu line or press ALT + F using keyboard.

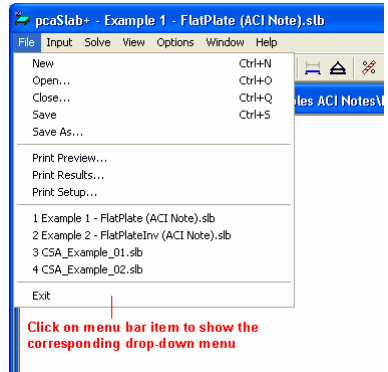

Enable/Disable Options

Some commands in the pop-up menus or input controls in the dialog boxes are black while others are gray. Commands that are black are available for use at that time. Commands that are gray are not available but may become available depending on the data you enter.

For example, in the **Input** menu, the **Reinforcing Bars** command is gray at the start of a new file. When you change the Run Mode from Design to Investigation in the **General Information** dialog box you will notice that the **Reinforcing Bar** command becomes black and is now ready for your input.

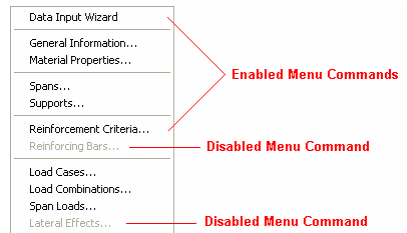

Frame Boxes

A frame box groups some related objects together, such as text boxes or option buttons.

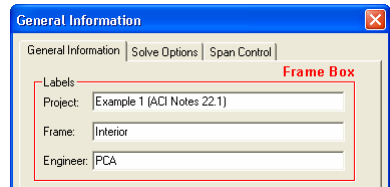

List Boxes

A list box displays a list of choices or items. If there are more choices than can fit in the box, scroll bars are provided so you can move quickly through the list.

The scroll bar is usually located to the right (vertical scroll bar) or at the bottom (horizontal scroll bar) of a list box. It has two directional arrows at either end (up and down, or left and right) in addition to a small rectangle called the scroll box.

The location of the scroll box with respect to the length of the bar indicates the proportion of the amount of the information in view to the whole list.

To scroll through information displayed in a list box one line at a time, click the up or down scroll arrow or, using the keyboard, press the arrow key that points in the direction you want to scroll. Another way is to click inside the scroll bar above or below the scroll box. This scrolls the list one screen at a time (the keyboard equivalent is pressing the PAGE UP or PAGE DOWN key). If you drag the scroll box in the scroll bar, the section of the list that moves into view depends on where you position the scroll box.

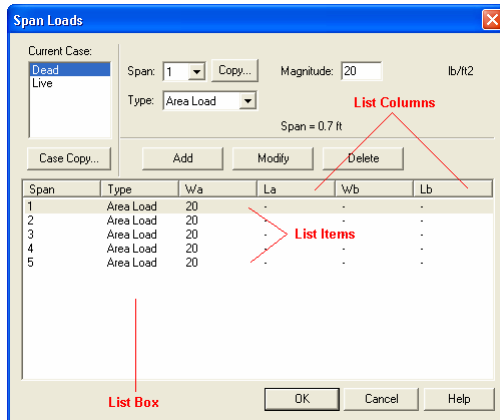

To select a single item from a list box click the scroll arrows until the item you want to select appears in the list box. Click the item. Using the keyboard, use the directional arrow keys to scroll to the item you want.

To select multiple sequential items in a list click the first item you want to select and then drag the cursor to the last item you want to select. Alternatively, click on the first item you want to select, press and hold down the SHIFT key, and click on the last item you want to select. Both items, and all items in between, are selected. To cancel the selections, release the SHIFT key and click any item.

Using the keyboard, use the UP ARROW or DOWN ARROW key to move the cursor to the first item you want to select. Press and hold down the SHIFT key. Continue to press the ARROW key repeatedly until all the items you want are selected. To cancel the selections, release the SHIFT key and press one of the ARROW keys.

To select multiple non-sequential items in a list press and hold down the CTRL key, and click each item you want to select. To cancel a selection, press and hold down the CTRL key, and click the item again. There are no keyboard equivalents for this procedure.

Selected items in a list box can be copied to the clipboard by simply pressing F3 after you make your selection. You will be able to view the contents of the

clipboard by opening the Clipboard Viewer in the Program Manager. Furthermore, the copied information can be transferred to other Windows applications (such as Microsoft Excel) using the application's **Edit/Paste** command. The transferred information will be indented and tabulated.

Option Buttons



An option button is used in a group of options from which you may select only one. A group of option buttons is a type of toggle (on/off) switch that when one option button is chosen, its state is toggled on and all other option buttons are toggled off. For example, in the **General Information** dialog box you will see option buttons. When using a mouse, place the cursor over the option desired and click the left button once to toggle the switch on. When using the keyboard keys, tab to the group of options and choose one by using the up and down arrow keys to toggle the switch.

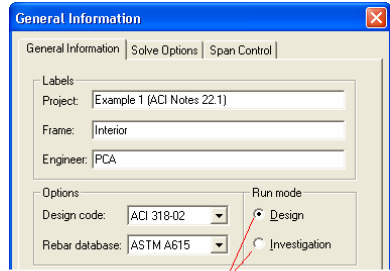

Option buttons

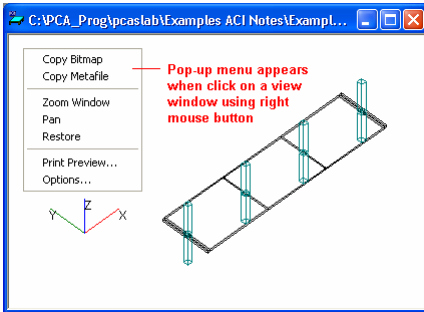

Pop-up Menu



A pop-up menu is the menu that is shown when you click the right mouse button on a view window. The commands on a pop-up menu are usually the commonly used commands associated with the view window that you right click on.

Tabs

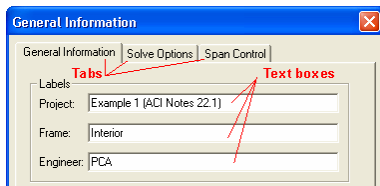

Tabs are different dialog boxes that are integrated together in a more compact interface. Each tab is actually a dialog box itself and each tab has a tab title. For example, there are three tabs in the image shown above and the titles for them are Slabs, Longitudinal Beams, and Ribs, respectively. You may see different text boxes, option buttons, etc. on different tabs. To push a tab to the top or to activate a tab, single click the left mouse button on the title of the tab that you want to access. Once a tab is activated (on the top), other tabs are covered by the activated one and cannot be accessed.

Text Boxes

Text Boxes are rectangular boxes inside dialog boxes that require text to be completed. In some cases, the edit box will contain only a flashing cursor located at the left side of the box prompting you to enter text. In other cases there may already be text in the text boxes. This text can be overwritten when you begin typing. To erase the text, use the backspace or the delete keys.

Main Window

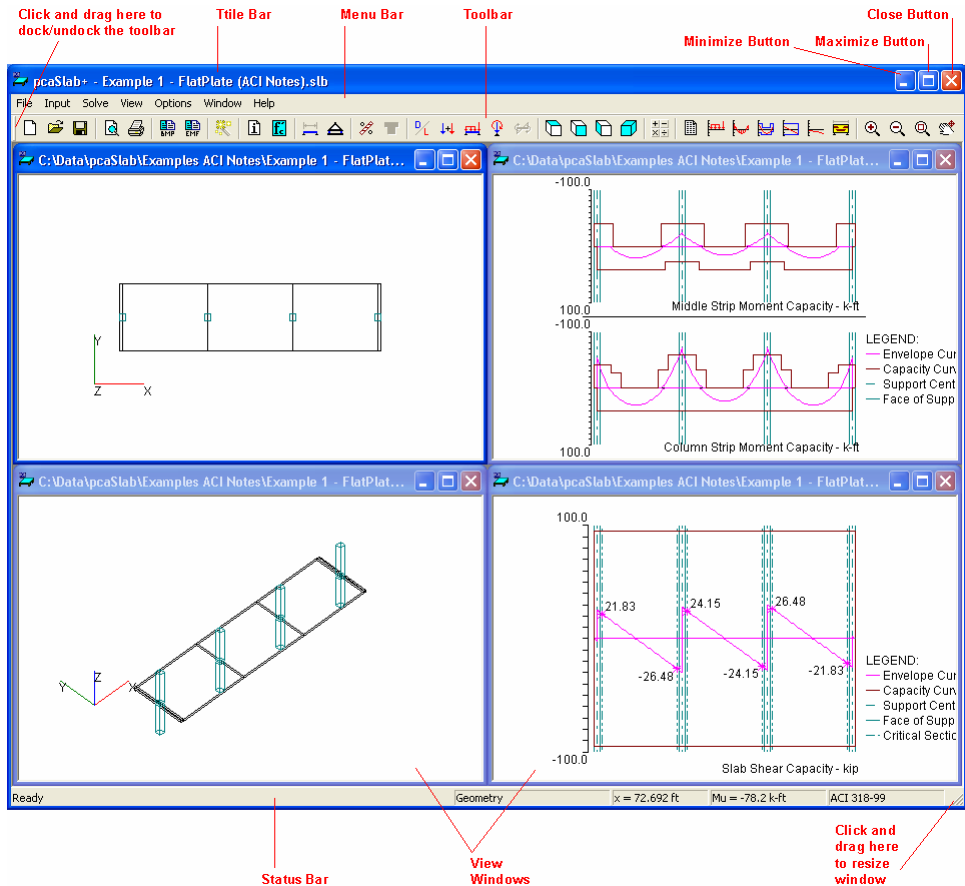

The main screen will appear after the pcaSlab is started as shown above. The main screen consists of a title bar, menu line, toolbar, five view windows and status bar.

The pcaSlab name and current data file name is shown in the title bar. All the menu commands can be accessed from the menu line and some frequently used commands also can be accessed from the buttons in the tool bar. The four view windows show the geometry of a floor system and the loads on it. Plan view, side view, elevated view and isometric view are available. The status bar shows the current states of pcaSlab.

Title Bar



The title bar displays the pcaSlab name, and following the hyphen, displays the name of the current data file you are using. If the data you are currently working on has not been saved into a file, the word pcaSlab1 is displayed in the title bar. If you start an other new data file by clicking the NEW button on the most left of the tool bar, the next data file is named as pcaSlab2, and so on.

Menu Bar

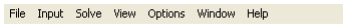

Located directly below the title bar is the menu line. pcaSlab commands are listed in the pop-up menus located in the menu line. These menu commands allow you to perform functions that create, view, and ultimately design the floor system.

In the pcaSlab program there are seven main pull-down menus: **File**, **Input**, **Solve**, **View**, **Options**, **Windows**, and **Help**. To access a menu item using the mouse, place the arrow cursor on the menu item you want and click the left mouse button. Each menu item can also be selected with the keyboard keys by simultaneously pressing the ALT key and the underlined letter of the menu you want to open. For example, to open the **F**ile menu, press ALT + F. To close a menu without selecting a command, move the cursor to any blank area on the screen and click the left mouse button. Press ESC key to close a menu using the keyboard keys.

To select a command from a menu with the mouse, place the arrow on the item you want, and click the left mouse button. In some cases, you will be told to double click on a selection, that is, press the mouse button twice, quickly. Anytime you have to wait, for example, when loading the program or designing the system, the mouse cursor becomes an hourglass cursor. It will return to its original state when the task is completed.

To select a command from a menu using the keyboard, use the down arrow key to highlight your choice and press ENTER key or press the keyboard key of the

command's underlined letter. The space bar is also equivalent to pressing the left mouse button.

Special instructions for inputting with the keyboard keys are given wherever necessary.

Tool Bar



Located directly below the menu line is the tool bar. Some frequently used buttons can be found in the tool bar. A description of the corresponding button is shown in the status bar (on the bottom of the window) when the mouse cursor is moving over this button. In addition to the description in the status bar, a brief tip is shown in a light yellow colored pop-up window close to the corresponding button when a mouse cursor is hanging over the button for a short period of time. Exactly the same functions or features can be accessed from either the menu items or tool bar buttons.

The tool bar can be changed from docking status to floating status by single clicking the left mouse button on the tool bar and dragging it away from the docking position to any other positions on the screen. A floating tool bar can be resized by clicking and dragging its borders.

To restore the tool bar to the docking status, single click the left mouse button on the tool bar and drag it to the location that is directly below the menu line and release the mouse button.

View Windows

A total of 10 view windows can be used to show Plan, Elevated, Side and Isometric views of the geometry, as well as Loads, Shear and Moment, Moment Capacity, Shear Capacity, Deflection, and Reinforcement.

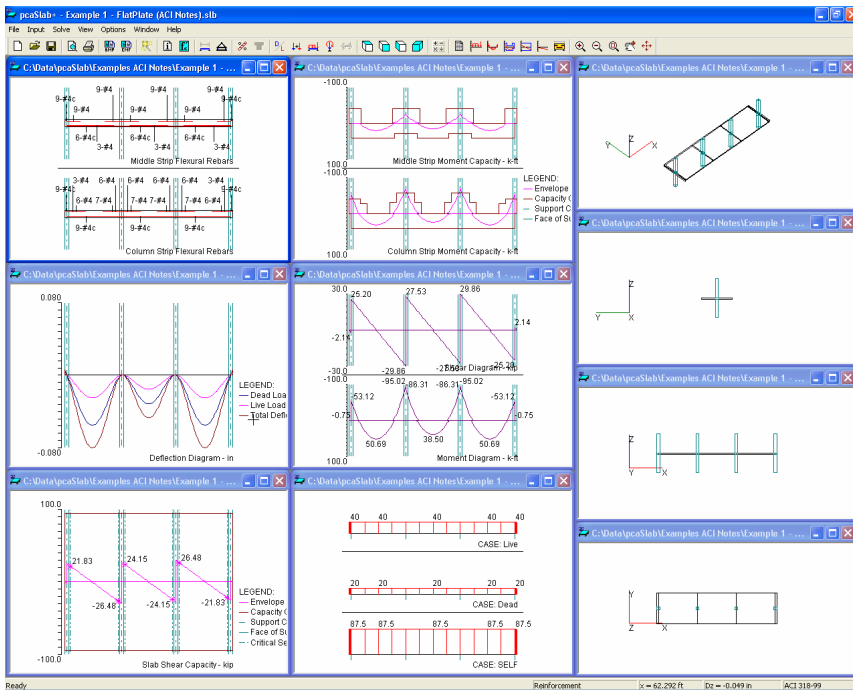

Status Bar

Status bar is always on the bottom of the main window. The status bar shows the current status of the data file and the coordinate values of the mouse cursor position.

For example, the figure above shows that pcaSlab is ready to take user input and the current view window is Deflection View. The "x=9.044 ft" is the horizontal coordinate of the mouse cursor (shown as "+" symbol) and the "Dz=-0.055 in" shows the current vertical value of the mouse cursor. Depending on the active view window, different information of the mouse cursor will appear in the status bar.

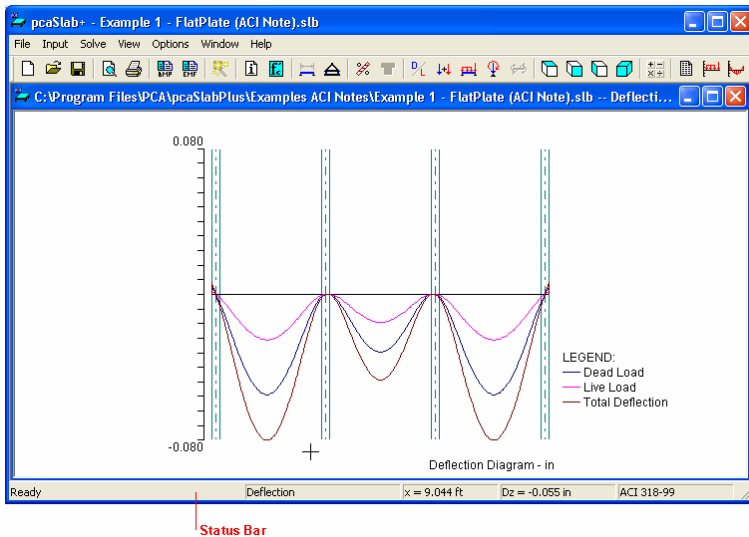

File Menu

The **File** menu is used for saving or retrieving data, printing, and exiting. The **File** menu contains the following commands: **New**, **Open**, **Close**, **Save**, **Save As**, **Print Preview**, **Print Results**, **Print Setup**, **Recent Files** and **Exit**.

New	Ctrl+N
Open...	Ctrl+O
Close...	Ctrl+Q
Save	Ctrl+S
Save As...	
Print Preview...	
Print Results...	
Print Setup...	
1 Example 1 - FlatPlate (ACI Note).slb	
2 JHU TYP INTERIOR.slb	
Exit	

New

The **New** command clears any data input and returns to the default values. Thus, you are able to create a new data file. However, before you can begin a new data file, pcaSlab will ask whether you want to save the current data. Answering YES will save the old data and begin a new data file. Answering NO will discard any changes to the data and begin a new data file. Answering CANCEL will return you to pcaSlab so that you can continue to work with the current data.

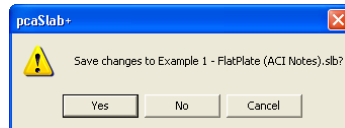

Open

The **Open** command allows you to load an existing pcaSlab data file. The dialog box that appears shows you a listing of all the files with the extension contained in

the default data directory or in the current directory (if a default data directory was not specified). This box also enables you to change the current drive and directory. If you are currently working on a data file and select the **Open** command, pcaSlab will ask whether you want to save the current data. Answering YES will save the old data and display the **Open** dialog box. Answering NO will discard any changes to the data and display the **Open** dialog box. Answering CANCEL will return you to pcaSlab so that you can continue to work with the current data.

Close



The **Close** command allows you to close the current pcaSlab data file. If you are currently working on a data file and select the **Open** command, pcaSlab will ask whether you want to save the current data. Answering YES will save the old data and display the **Open** dialog box. Answering NO will discard any changes to the data and display the **Open** dialog box. Answering CANCEL will return you to pcaSlab so that you can continue to work with the current data.

Save



The **Save** command saves the changes you've made to the current data under that same filename. The new data overwrites the old data, and you cannot retrieve the old data. It is a good practice to periodically save while inputting data. If a data file is untitled, the **Save As** dialog box will appear.

Save As



The **Save As** command allows you to name or rename a data file. Use Save As when you want to save both the original data and any changes you've currently made to the data. The original data remains under the old filename. If a file of the same name exists, the program will ask if you would like to overwrite the file.

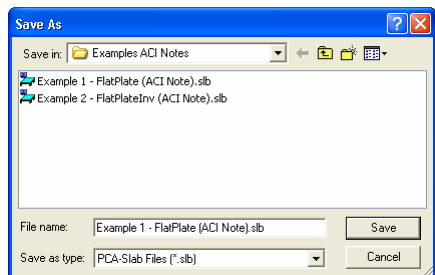

Print Preview



The **Print Preview** command allows you to preview and print the current view window (floor system geometry in the plan, elevated, and isometric views, prints the shear and moment diagrams, and prints the deflected shapes). To obtain a view window you must first perform the design, then select what you want to view from the **View** menu. You may have more than one view windows opened. The current

view window is the one activated and on top of the others on your screen. Selecting this command closes the pcaSlab main window and opens the print preview window as shown below. On the print preview window, press the ZOOM IN or ZOOM OUT buttons or simply click the left mouse button on the preview window to magnify or reduce the size of the preview paper. Press the NEXT PAGE button if more than one page needs to be printed. Press the PRINT button to print the view. The printer could be a local printer, which is connected to your computer directly, or a network printer. Press the CLOSE button to close the preview window and go back to pcaSlab.

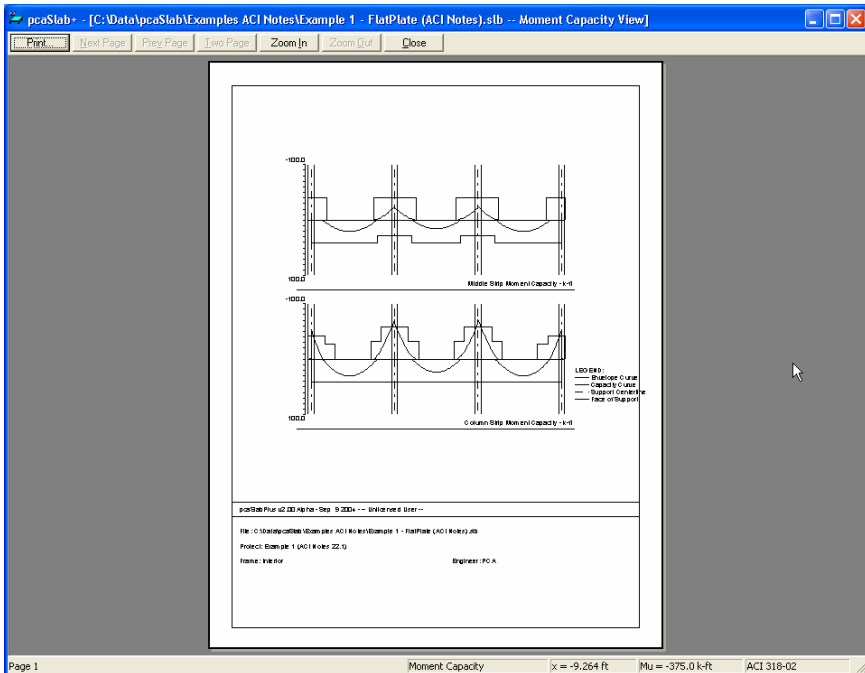

Print Results

The **Print Results** command allows you to send the analysis and/or design results to the printer. Selecting this command will show the **Results Report Setup** dialog box. By selecting items in the **Selection** group prior to performing the print, you can print selected sections of the data instead of the entire analysis. Option **Include Non-redistributed Internal Forces** is available only for beams/one-way slab systems if moment redistribution is engaged. It allows including in the report

non-redistributed internal forces in addition to redistributed values which are printed by default.

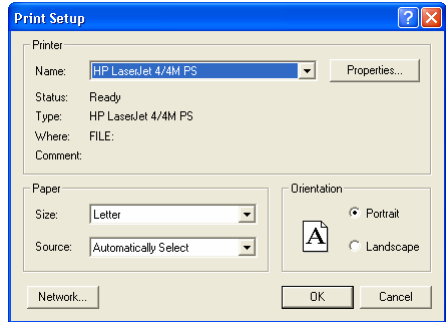
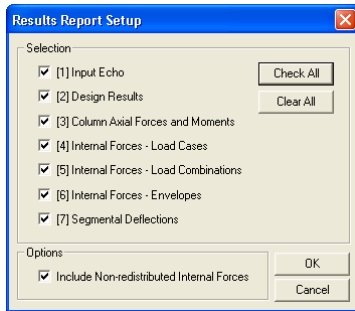

Printer Setup

The **Printer Setup** command brings up the Windows printer setup box which allows the user to select the printer to send the output to and to change the settings of the printer.

Recent Files

This list contains the data files that are used recently and can be accessed quickly from the menu by a single click. The most recently used one is on the top of the list. Up to four files can be listed.

Exit

The **Exit** command ends the pcaSlab session and returns you to Windows. If you have made any changes to your data and have not saved them, pcaSlab will first ask whether you want to save or abandon any changes you've made before you exit.

Input Menu

The **Input** menu allows you to enter and modify data for the floor system. The **Input** menu contains the following commands: **Data Input Wizard**, **General Information**, **Material Properties**, **Spans**, **Supports**, **Reinforcement Criteria**, **Reinforcing Bars**, **Load Cases**, **Load Combinations**, **Span Loads**, **Support Loads and Displacements**, and **Lateral Effects**.

Data Input Wizard
General Information...
Material Properties...
Spans...
Supports...
Reinforcement Criteria...
Reinforcing Bars...
Load Cases...
Load Combinations...
Span Loads...
Support Loads and Displacements...
Lateral Effects...

Data Input Wizard

The **Data Input Wizard** command is designed to make the inputting process easier. By selecting **Data Input Wizard**, a logical sequence of dialog boxes will automatically be displayed allowing you to enter data for your floor system.

General Information

The **General Information** consists of three tabs: **General Information**, **Solve Options**, and **Span Control**.

The **General Information** tab will allow you to enter the project name, frame name, engineer name, design code, rebar database, run mode, and number of supports. You must always use the **General Information** tab before doing any further inputting since it affects the availability of other commands in this menu.

The **Solve Options** command allows you to specify design options and deflection calculations options. Please note that design options for two-way systems are different from beams/one-way slab systems. To take effect, this command must be used prior to **Execute**.

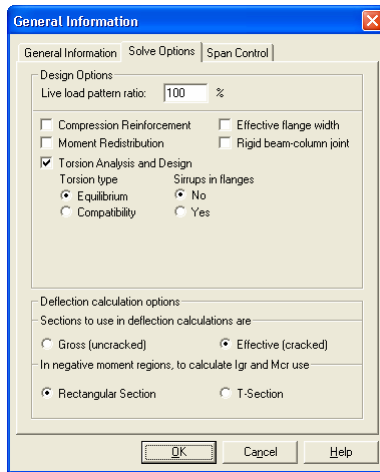
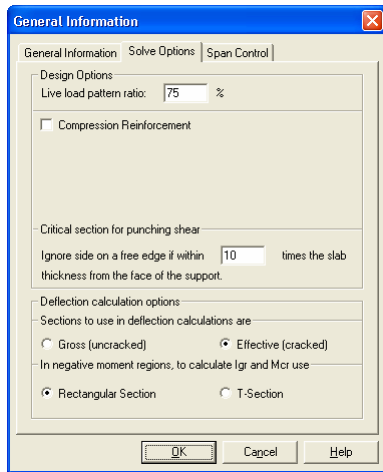
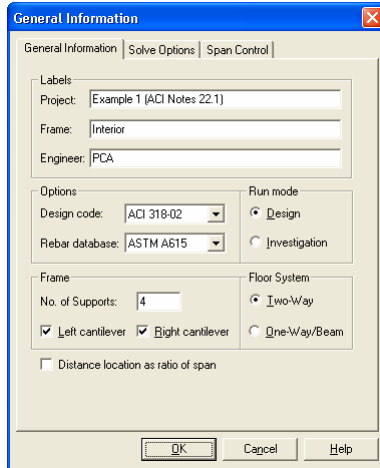

The **Span Control** tab provides commands for span manipulation such as inserting new spans, copying spans, moving spans, and deleting spans.

Material Properties

The **Material Properties** command enables you to input material property requirements for concrete and reinforcement. Concrete density, compressive strength, Young’s modulus, rupture modulus, as well as the longitudinal and shear reinforcement yield levels, are required.

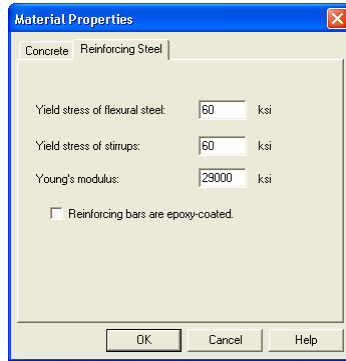
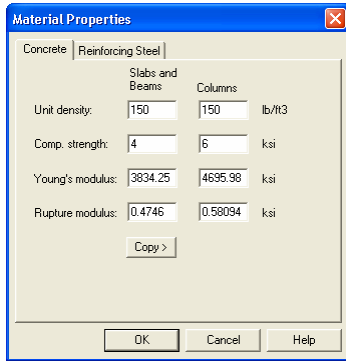

Spans

The **Spans** menu allows you to input geometric dimensions for slabs, longitudinal beams, and ribs.

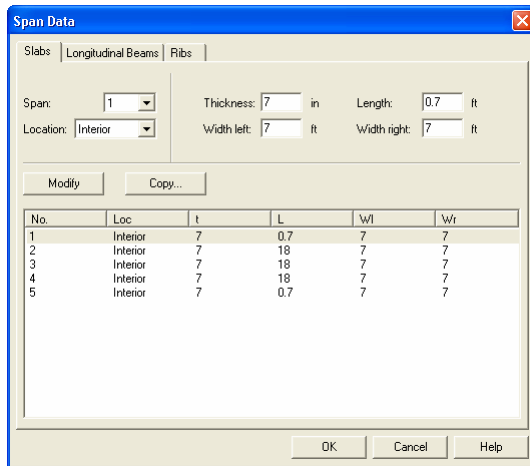

Supports

The **Supports** menu allows you to input geometric dimensions for columns, drop panels, column capitals, and transverse beams. The percentage of the actual column joint stiffness to be used in the analysis to determine the joint moments and shears can be modified on the **Columns** tab. The **Drop Panels** tab is available if two-way system is selected and the **Moment Redistribution** tab is available only for beams/one-way slab systems if moment redistribution is engaged in the **General Information** window.

Support Data

Columns | Drop Panels | Column Capitals | Transverse Beams | Boundary Conditions

Support: 1

Stiffness share %: 100

Height (ft) c1 (in) c2 (in)

Above: 9 16 16

Below: 9 16 16

Check punching shear around column

Modify Copy...

No.	Stiff%	HtA	C1A	C2A	HtB	C1B	C2B	Shear
1	100	9	16	16	9	16	16	Yes
2	100	9	16	16	9	16	16	Yes
3	100	9	16	16	9	16	16	Yes
4	100	9	16	16	9	16	16	Yes

OK Cancel Help

Support Data

Columns | Column Capitals | Transverse Beams | Moment Redistribution | Boundary Conditions

Support: 1

Stiffness share %: 100

Height (ft) c1 (in) c2 (in)

Above: 11 10 10

Below: 11 10 10

Modify Copy...

Sup. No.	Stiff%	HtA	c1A	c2A	HtB	c1B	c2B
1	100	11	10	10	11	10	10
2	100	12	11	11	12	11	11
3	100	13	12	12	13	12	12
4	100	14	13	13	14	13	13

OK Cancel Help

Reinforcement Criteria

The **Reinforcement Criteria** menu allows you to specify the distance to reinforcement, reinforcement bar sizes, bar spacing, and reinforcing ratio for both slabs and beams.

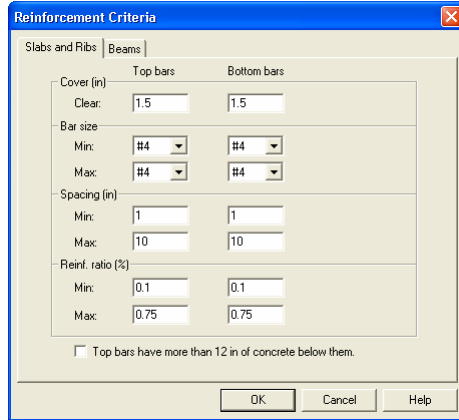

Reinforcement Bars

For two-way floor systems, the **Reinforcement Bars** menu allows you to specify the longitudinal reinforcement arrangement information for column strip, middle strip, and beam, as well as shear reinforcing information for beams.

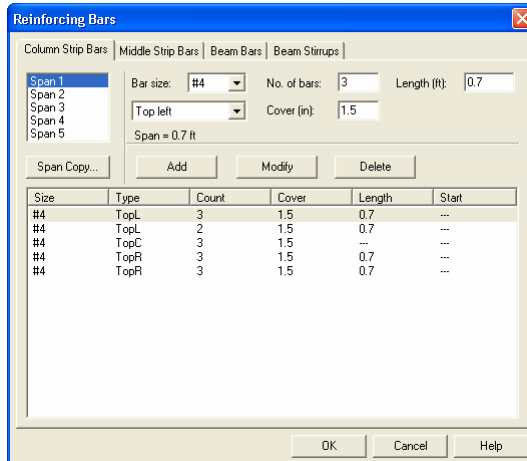

For beams/one-way slab systems, flexural bars, stirrups, and torsional longitudinal reinforcement can be specified. The **Reinforcement Bars** menu is disabled if **Run Mode** of Design is selected from the **General Information** dialog box. Select the **Run Mode** of Investigation from the **General Information** dialog box to enable it.

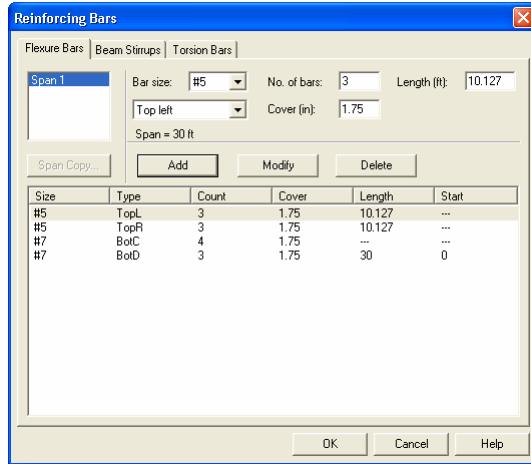

Load Cases

The **Load Cases** menu allows you to specify load cases. Up to six load cases can be added and only one live load case is allowed.

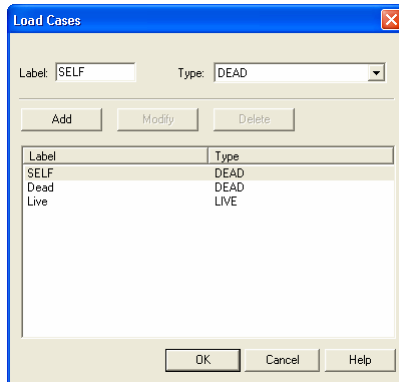

Load Combinations

The **Load Combinations** menu allows you to specify load combinations as shown in Figure 3-34. Up to twenty load combinations can be added.

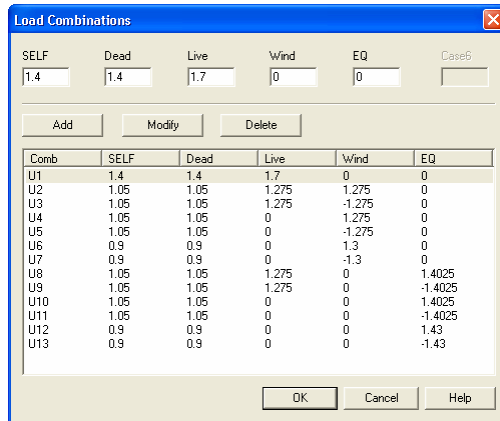

Span Loads

The **Span Loads** menu allows you to enter superimposed area loads, line loads, point loads, and moments.

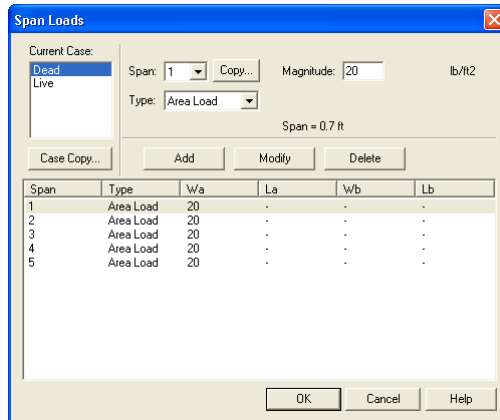

Support Loads and Displacements

The **Support Loads and Displacements** menu allows you to enter prescribed displacements and rotations of supports as well as concentrated loads applied directly at support locations.

Support Loads and Displacements

Current Case: Dead
Live

Support: 1

Displacement/Rotation: Dz: 0 in, Ry: 0 rad

Force/Moment: Fz: 0 kip, My: 0 k-ft

Modify Copy...

Supp No.	Dz	Ry	Fz	My
1	0	0	0	0
2	0	0	0	0
3	0	0	0	0
4	0	0	0	0
5	0	0	0	0

OK Cancel Help

Lateral Effects

The **Lateral Effects** menu allows you to enter the lateral loads as moments acting on the two ends of each span.

Lateral Load Effects

Current Case: s

Span: 1

Moment at left: 0 k-ft

Moment at right: 0 k-ft

Modify Copy...

No.	Mleft	Mright
1	0	0
2	0	0
3	0	0
4	0	0
5	0	0

OK Cancel Help

Solve Menu

Execute... F5
Results Report... F6

The **Solve** menu contains commands that enable you to perform the analysis and/or design of the floor system and view the results. The **Solve** menu contains the following commands: **Execute** and **Report**.

Execute

The **Execute** command executes the solver portion of pcaSlab. If some data is still required when this command is executed, pcaSlab will respond with an "Invalid Model!" error message. The missing data must be completed before execution. A status window pops up and shows the status during the execution. If the execution is not successful, an error message will be shown and the execution is terminated.

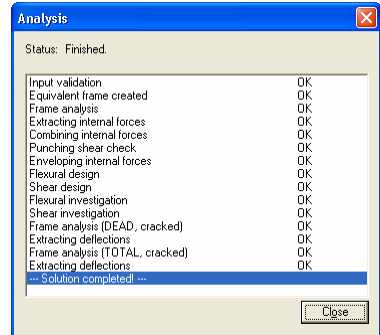
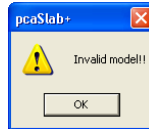

Results Report

The **Results Report** command brings up a window with text results of the analysis and/or design as shown below. From this window, results can be copied to clipboard or printed using **Copy** and **Print** command buttons.

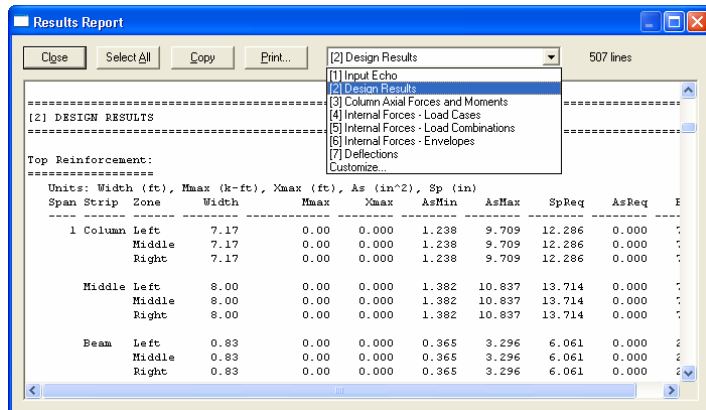

To change the content of report, select items [1] through [7] from the combo box. Item **Customize** brings up the Results Report Setup window described earlier (Print **Results**, page 3-12). It will allow you to generate a report with multiple item selected.

View Menu

The **View** menu commands enable you to modify the floor system's appearance on the screen to suit your viewing needs and enable you to view the result diagrams. The **View** menu contains the following commands: **Zoom**, **Pan**, **Restore**, **Plan View**, **Elevated View**, **Side View**, **Isometric View**, **Change View Angles...**, **View Options...**, **Loads**, **Internal Forces**, **Moment Capacity**, **Shear Capacity**, **Deflection**, **Reinforcement**, and **Duplicate Active View**.

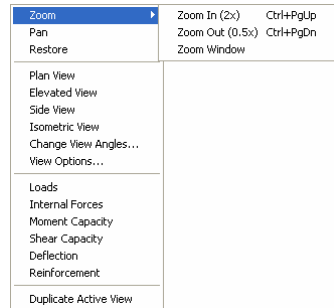

Zoom

The **Zoom** menu contains a cascade sub-menu, which enables you to zoom in and out on any portion of your floor system. Select **Window** from the sub-menu and use the mouse to specify a zooming region; the program will enlarge the portion you select. Select the **In(2x)** or **Out(0.5x)** to enlarge or reduce the model by two times, respectively.

Pan

The **Pan** command allows you to move your model on the plane of the screen. You may move the model in any direction. The mouse cursor is changed to a palm shape once the **Pan** command is selected. Press and hold the left mouse button on the view window and drag to the new location. After the mouse button is released, the model is moved in the same distance and direction as the mouse cursor from the original position.

Restore

The **Restore** command will redraw the floor system in full size. If you have altered your screen view using the **Zoom** command, select **Restore** to restore the figure's original proportions.

Plan View



Select **Plan View** command to show the plan view window.

Elevated View



Select **Elevated View** command to show the elevated view window.

Side View



Select **Side View** command to show the side view window.

Isometric View



Select **Isometric View** command to show the isometric view window.

Change View Angles



The **Change View Angle** command allows you to modify the angle at which the floor system is displayed in the Isometric View. The default angles are set at -45 about the X axis and 45 about the Z axis. A more convenient way to change the view angle is to use the keyboard short cut CTRL + ARROW KEYS. To rotate around Z axis, press CTRL + ← or CTRL + →. To rotate around X axis, press CTRL + ↑ or CTRL + ↓.

View Options



The **View Options** command allows you to view selected members of the floor system in the view windows. Clicking the left mouse button on the check boxes next to the items in the dialog box, or tabbing to the member type and pressing the space bar will toggle the selection. pcaSlab will draw any members that contain a ✓ in the box.

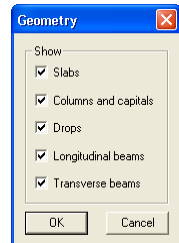

Loads



Select **Loads** command to show the load view window.

Internal Forces



Select **Internal Forces** command to show the shear, moment, and torsion (for beams/one-way slab systems only) diagram view window. The analysis and/or design must be performed before selecting this command. Otherwise “Problem Not Solved” message will be shown instead.

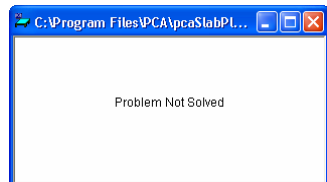

Moment Capacity



Select **Moment Capacity** command to show the moment capacity diagram view window. The analysis and/or design must be performed before selecting this command. Otherwise “Problem Not Solved” will be shown instead.

Shear Capacity



Select **Shear Capacity** command to show the shear capacity diagram view window. The analysis and/or design must be performed before selecting this command. Otherwise “Problem Not Solved” will be shown instead.

Reinforcement



Select **Reinforcement** command to show the reinforcement view window. The analysis and/or design must be performed before selecting this command. Otherwise “Problem Not Solved” will be shown instead.

Deflection



Select **Deflection** command to show the deflection diagram view window. The analysis and/or design must be performed before selecting this command. Otherwise “Problem Not Solved” will be shown instead.

Duplicate Active View



Select **Duplicate Active View** to make a copy of the current active view window.

Options Menu

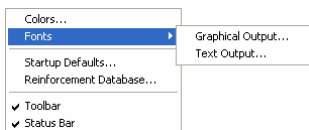

The **Options** menu allows you to change the startup options of the pcaSlab program to suit your needs. The **Options** menu contains the following commands: **Colors**, **Startup Defaults**, **Rebar Database**, **Toolbar**, and **Status Bar**.

Colors



The **Colors** command allows you to change the background color, member color, load color, text color, diagram color, etc. You may save the new colors as default setting, which will be used when pcaSlab is executed in the future.

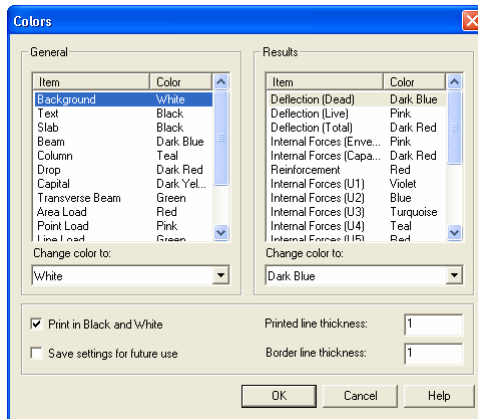

Fonts

The **Fonts** command allows you to select properties of the font that will be used in the graphical output window and printout, **Graphical Output**, as well as in the text result window and output, **Text Output**. Please note that for the Text Output only nonproportional (fixed width) fonts can be used.

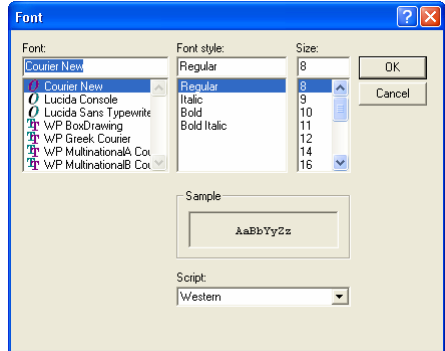
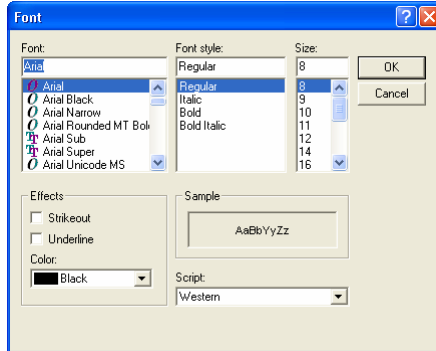

Startup Defaults

The **Startup Defaults** command allows you to enter engineer name, change the default design code, reinforcement database, and the data directory, a directory where the program looks for data when it is executed.

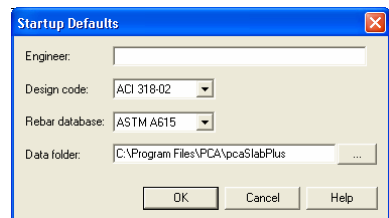

Reinforcement Database



The **Rebar Database** command allows you to view the pre-defined rebar information and define your own database. The user-defined database can be selected from the **General Information** dialog box.

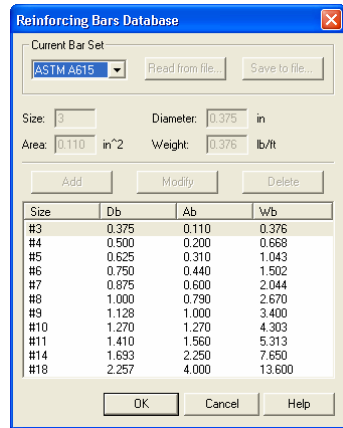

Toolbar



Check the **Toolbar** command with a ✓ sign to show the tool bar. Select the command again to clear the ✓ sign to hide the tool bar. The tool bar is shown by default.

Status Bar



Check the **Status Bar** command with a ✓ sign to show the status bar. Select the command again to clear the ✓ sign to hide the status bar. The status bar is shown by default.

Window Menu



This menu enables you to arrange view windows shown on screen. The **Window** menu contains the following commands: **Cascade**, **Tile Horizontal** and **Tile Vertical**.

Cascade



The **Cascade** command displays all the open windows in the same size, arranging them on top of each other so that the title bar of each is visible. The current active view window will be on the top after the execution of the **Cascade** command.

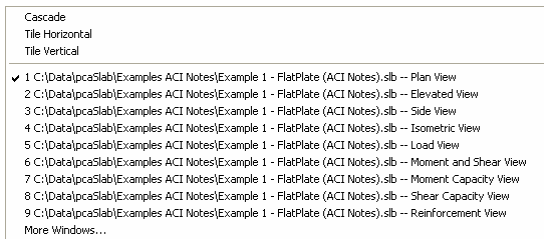

Tile Horizontal



The **Tile Horizontal** command arranges all open windows horizontally so that no window overlaps another. The current active view window will be on the most left

or on the upper-left corner of the screen after the execution of the **Tile Horizontal** command.

Tile Vertical



The **Tile Vertical** command arranges all open windows vertically so that no window overlaps another. The current active view window will be on the most left or on the upper-left corner of the screen after the execution of the **Tile Vertical** command.

Window List



The remaining menu items are in a list of the windows that are available for viewing. Selecting any window from this menu will bring up or restore the window to its previous size and position if it was minimized.

Help Menu



Help Topics...	F1
Context Help...	Shift+F1
About pcaSlab...	

The **Help** menu includes commands that enable you to obtain online help for the program and show the copyright and registration information about your software. The **Help** menu contains three commands: **Help Topics**, **Context Help** and **About pcaSlab**.

Help Topics



The **Help Topics** command shows the Windows Help window with a table of contents. Select a topic of your interest to display information about that item. More information on the help system can be obtained from the Microsoft Windows manual.

Context Help



The **Context Help** command enters the program into the context-sensitive help mode which is indicated by a question mark  attached to the mouse cursor. In this mode, the user can click the element for which information is needed and the program will display the help topic associated with this element. More information on the help system can be obtained from the Microsoft Windows manual.

About pcaSlab/pcaBeam



The **About pcaSlab** command shows the version number of the program, the licensing information, and the copyright information. In the case of a trial license, the expiration date is given as well as the locking code which is needed to obtain a standalone license.

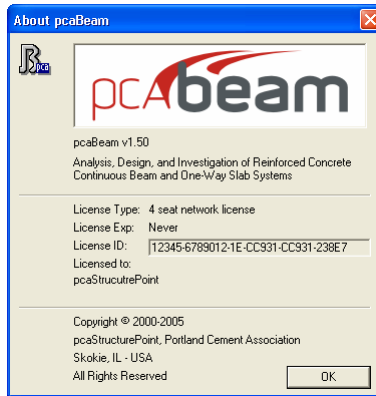
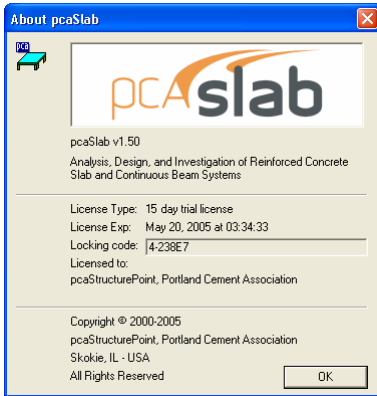

The Control Menu

All the view windows have one pull-down menu located in the upper left hand corner of the open window. This is the **Control** menu. To access the **Control** menu, press CTRL + F6 to cycle through the windows and press ALT + - (hyphen), to open the Control menu of the desired window. The following is a list and a brief description of the commands in this menu.

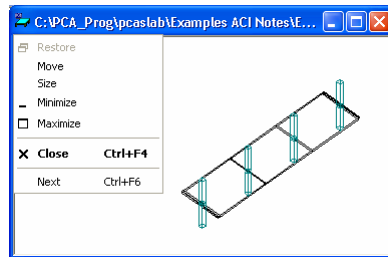

Restore

The **Restore** command will restore a window or an icon to its previous size and position. This menu item is available when the window is iconized or maximized.

Move

The **Move** command moves the window to a new location. Select **Move** and use the ARROW KEYS to move the window in the desired direction and select ENTER to accept the new location.

Size

The **Size** command resizes a window. Select **Size** and use the ARROW KEYS to move the border of the window in the desired direction and select ENTER to accept the new size.

Minimize

The **Minimize** command reduces a window to an icon and positions it at the bottom of the screen.

Maximize

The **Maximize** command enlarges a window to fit your entire screen.

Close

The **Close** command is used to close a window and return it to an icon and the bottom of the screen.

Next

The **Next** command switches among open windows and icons.

Program Toolbar

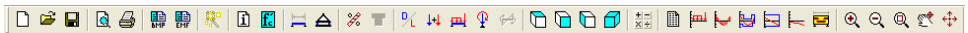

Close the current data file if there is one and start a new data file. The equivalent menu command is **File/New**.



Open an existing data file on hard disk. The equivalent menu command is **File/Open**.



Save the current data file to hard disk. The equivalent menu command is **File/Save**. If you have not changed the default file name (pcaSlab1, pcaSlab2, etc.), the equivalent menu command is **File/Save As**.



Print view window. The equivalent menu command is **File/Print View**.



Print results. The equivalent menu command is **File/Print Results**.





















Copy Bitmap to clipboard. The bitmap then can be pasted to a word processing or presentation software such as Microsoft Word or Microsoft PowerPoint.



Copy Metafile to clipboard. The metafile then can be pasted to a word processing or presentation software such as Microsoft Word or Microsoft PowerPoint.



Open the Data Input Wizard. The Data Input Wizard will guide you to enter the necessary input to your project. The equivalent menu command is **Input/Data Input Wizard**.

-  Enter general information. The equivalent menu command is **Input/General Information**.
-  Enter material properties. The equivalent menu command is **Input/Material Properties**.
-  Enter span geometry information for slabs, longitudinal beams, and ribs. The equivalent menu command is **Input/Spans**.
-  Enter support information for columns, drop panels, column capitals, and transverse beams. The equivalent menu command is **Input/Support**.
-  Enter reinforcement criteria for slab and ribs, and beams. The equivalent menu command is **Input/Reinforcement Criteria**.
-  Enter reinforcing bar information for column strips, middle strips, beams, and beam stirrups. This button is disabled if **Design** run mode is selected from the **General Information** dialog box. The equivalent menu command is **Input/Reinforcing Bars**.
-  Enter load cases. The equivalent menu command is **Input/Load Cases**.
-  Enter load combinations. The equivalent menu command is **Input/Load Combinations**.
-  Enter span loads. The equivalent menu command is **Input/Span Loads**.
-  Enter support loads and displacements. The equivalent menu command is **Input/Support Loads and Displacements**.
-  Enter lateral effects. The equivalent menu command is **Input/Lateral Effects**.
-  View plan geometry. The equivalent menu command is **View/Plan View**.
-  View elevated geometry. The equivalent menu command is **View/Elevated View**.
-  View side geometry. The equivalent menu command is **View/Side View**.
-  View isometric geometry. The equivalent menu command is **View/Isometric View**.
-  Execute the analysis and/or design. The equivalent menu command is **Solve/Execute**.
-  View results. The equivalent menu command is **Solve/Report**.
-  View loads. The equivalent menu command is **View/Loads**.
-  View internal forces within the whole system or a single span. The equivalent menu command is **View/Internal Forces**.



View moment capacity of the whole geometry or a single span. The equivalent menu command is **View/Moment Capacity**.



View shear capacity of the whole geometry or a single span. The equivalent menu command is **View/Shear Capacity**.



View deflection of the whole geometry or a single span. The equivalent menu command is **View/Deflection**.



View flexure reinforcement for beam strip, middle strips, and column strips. View shear reinforcement for beam strips. The equivalent menu command is **View/Reinforcement**.



Zoom in view window to magnify the system. The equivalent menu command is **View/Zoom/In(2x)**.



Zoom out view window to reduce the system. The equivalent menu command is **View/Zoom/Out(0.5x)**.



Zoom any part of a view window. The equivalent menu command is **View/Zoom/Window**.



Move the model in the screen plane. The equivalent menu command is **View/Pan**.



Restore a view window. The equivalent menu command is **View/Redraw**.

Chapter 4

Operating *pcaSlab/pcaBeam*

Working with Data Files (menu File)



Creating a New Data File



When you first load *pcaSlab* you will have a new file ready for input. The data will not have a filename associated with it, therefore, "pcaSlab1" will appear in the title bar. If a new data file is created after the "pcaSlab1", the new data file will be named as "pcaSlab2", and so on.

To start a new data file:

1. If you are already in the program and in an existing file, select **NEW** button  or **New** menu command to clear your screen and return you to the default settings. If existing data has been changed prior to executing the **New** command, *pcaSlab* will ask if you would like to save the data.
2. After **New** is selected, **Auto Input** command in the **Input** menu may be used. This command guides you through the inputting process by automatically displaying all the dialog boxes necessary to design your floor system. You may cancel the auto input mode by selecting **CANCEL** button from any dialog box.
3. After you enter data through the **Input** menu, use the **Save As** command to give the file a name.

Opening Existing Data File



pcaSlab allows you to open data files that were saved at an earlier time.

To open an existing data file:

1. Select **Open** command from the **File** menu or click the **OPEN** button  to bring in an existing *pcaSlab* data file. The dialog box of Figure 4-1 will be displayed. All the files with an .slb extension contained in the current drive and directory will be displayed in the list box. This dialog box also enables you to change the current drive and directory.

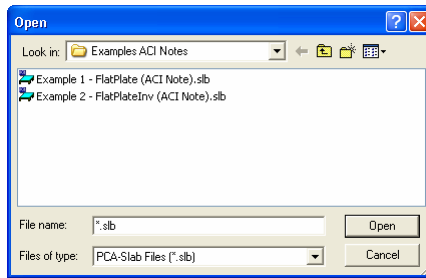



Figure 4-1 Open dialog box

2. Type in the name of the file you want to open. You may also select a file from the provided list with the mouse or using the keyboard by tabbing to the list and using the up and down arrow keys.
3. Press OPEN to exit the dialog box and allow pcaSlab to read the data. You may combine steps 2 and 3 of this procedure by double clicking the left mouse button over the desired file from the provided list.

Importing ADOSS and PCA-Beam Data File

pcaSlab and pcaBeam allow you to open ADOSS v6.0x/7.0x and PCA-Beam v1.0x data files that were saved at an earlier time.

To open an existing ADOSS or PCA-Beam data file:

1. Select **Open** command from the **File** menu or click the OPEN button . The dialog box of Figure 4-2 will be displayed. Select the type of the file you want to open and all files of the selected type contained in the current drive and directory will be displayed in the list box. This dialog box also enables you to change the current drive and directory.

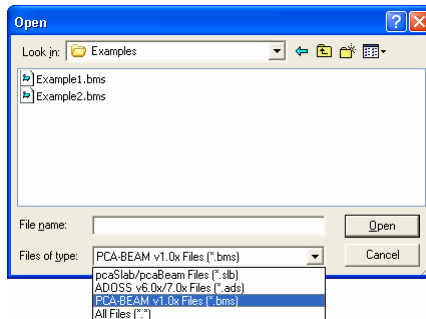



Figure 4-2 Importing ADOSS or PCA-Beam data file dialog box

2. Type in the name of the file you want to open. You may also select a file from the provided list with the mouse or using the keyboard by tabbing to the list and using the up and down arrow keys.
3. Press OPEN to exit the dialog box and allow pcaSlab to read the data. You may combine steps 2 and 3 of this procedure by double clicking the left mouse button over the desired file from the provided list.

Note: The extension name of an ADOSS v6.0x/7.0x file is .ADS and the extension name of a PCA-Beam v1.01 file is .BMS. Both pcaSlab and pcaBeam v1.5x use files with the .SLB extension.

Saving the Data File

To save your data with the same filename:

1. Select the **Save** command from the **File** menu or simply click the SAVE button . If the data has not been modified since the last save or **Save As** command was executed, this option will not be available. The file will be updated and the **Save** command and button will be shaded gray.

To give your data a new filename:

1. If you have not saved your data yet, select the **Save** or **Save As** command from the **File** menu. Either command will have the same effect. If you would like to save a data file that currently has a filename with a new filename, select the **Save As** command. The dialog box of Figure 4-3 will appear. When no filename has been given to the current data, the default filename is "pcaSlab1.slb", and it is highlighted in the edit box.

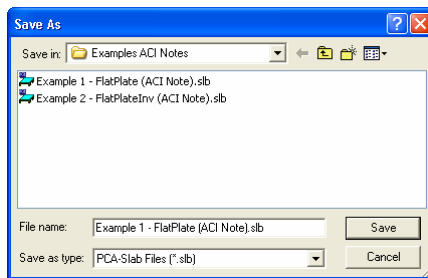

Figure 4-3 Save As dialog box

2. Type a new name to overwrite the current name.
3. Press SAVE to exit the dialog box and save the data into the filename specified.

Most Recently Used Files (MRU)

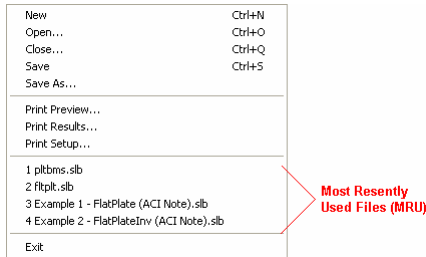



Figure 4-4 Most Recently Used File List (MRU)

The Most Recently Used Files (MRU) list shows the four data files that were opened most recently. Selecting a data file from this list makes it easier and faster to open the file. The list is empty when the program is executed for the first time.

Specifying the Model Data (menu Input)

Data Input Wizard

The **Data Input Wizard** is designed to make the inputting process easier. By selecting the **Data Input Wizard** from **Input** menu or selecting  from the tool bar, a logical sequence of dialog boxes will automatically be displayed allowing you to enter data for your floor system.

Defining General Information

The **General Information** command allows you to enter labels, design code, rebar database, run mode, and the frame information needed by pcaSlab to proceed with the input process. You must choose this command before doing any further inputting since this command affects the availability of the commands in the **Input** menu.

To enter general information:

1. Select the **General Information** command from the **Input** menu or click the  button from the tool bar. The dialog box of Figure 4-5 will appear.
2. Enter the project name, frame name, and engineer name in the Label frame box.
3. Select the building standard you want your floor system to be designed to (ACI 318-02, ACI 318M-02, ACI 318-99, ACI 318M-99, CSA A23.3-94, CSA A23.3-94E) from the Option frame box.

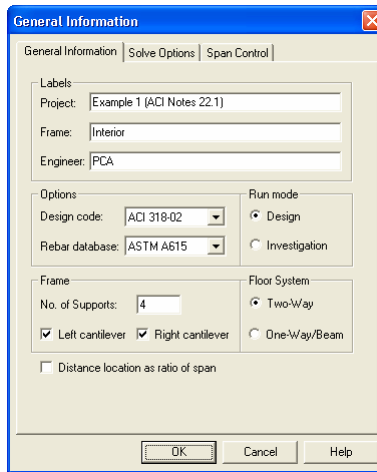

Figure 4-5 General Information dialog box

4. Select the **Design** or **Investigation** from the **Run mode** frame box.
5. In the **Frame** frame box, enter the Number of supports of the frame. The default number of supports is 2. The minimum and maximum number of spans is 1 and 20 spans, respectively. Therefore the minimum number of supports is 2 and the maximum number of supports is 21.
6. Check the Left cantilever and/or Right cantilever check boxes if left cantilever and/or right cantilever exist in the frame respectively.
7. In the Floor System frame box, select Two-Way or Beams/one-way slab option.
8. Check the Distance location as ratio of span if the locations of loads need to be entered as a ratio of the length of a span.
9. Press OK button to exit the dialog box and allow pcaSlab to use the new data. If using the Auto Input, click the NEXT button to the next dialog box.

Defining Solve Option

The **Solve Options** command allows you to select options and specify parameters that affect the analysis and design results. Please be advised that changing these settings involves engineering judgment and it has to be done cautiously. To take effect, this command must be used prior to the **Execute** command. The set of parameters is different for two-way and one-way systems.

Two-way systems

To specify solve options for two-way systems:

1. Enter the live load pattern ratio.
2. Check COMPRESSION REINFORCEMENT checkbox if it is to be considered when needed.
3. Enter the multiplier that defines the distance between a column face and a free edge of a slab, within which a segment of punching shear critical section is to be ignored.
4. Choose if GROSS (UNCRACKED) or EFFECTIVE (CRACKED) sections are to be considered in the deflection calculations.
5. Choose if in the case of a section with flanges in the negative moment region, only the web (RECTANGULAR SECTION) or the whole section (T-SECTION) is to be used to calculate the gross moment of inertia (I_g) and the cracking moment.

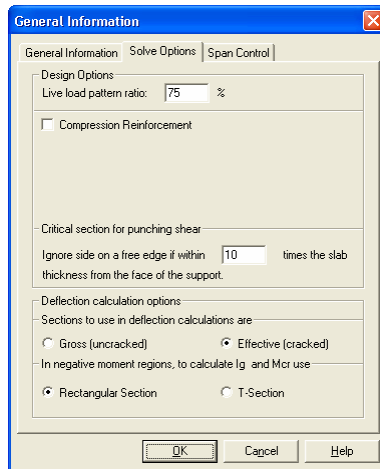

Figure 4-6 Solve Options for two-way systems

One way/beam systems

To specify solve options for beams/one-way slab systems:

1. Enter the live load pattern ratio. The default value for beams/one-way slab systems is 100%.
2. Check COMPRESSION REINFORCEMENT checkbox if it is to be considered when needed.

3. Check MOMENT REDISTRIBUTION checkbox if it is to be considered in the analysis. This option has to be checked for the MOMENT REDISTRIBUTION tab to be available in the SUPPORT DATA dialog box.
4. Check EFFECTIVE FLANGE WIDTH if instead of the full flange width only the effective flange width is to be considered in the flexural design.
5. Check RIGID BEAM-COLUMN JOINT to consider beam-column joint as rigid.
6. Check TORSION ANALYSIS AND DESIGN if they are to be included in the solution. This option has to be checked for the TORSION TYPE and STIRRUPS IN FLANGES options to be enabled. Also torsional loads will only be available in the TYPE combo box of the SPAN LOADS dialog box if this option is checked.
7. If TORSION ANALYSIS AND DESIGN is checked then select if EQUILIBRIUM or COMPATIBILITY torsion is to be considered and if for sections with flanges STIRRUPS IN FLANGES can be considered.
8. Choose if GROSS (UNCRACKED) or EFFECTIVE (CRACKED) sections are to be considered in the deflection calculations.
9. Choose if in the case of a section with flanges in the negative moment region, only the web (RECTANGULAR SECTION) or the whole section (T-SECTION) is to be used to calculate the gross moment of inertia (I_g) and the cracking moment.

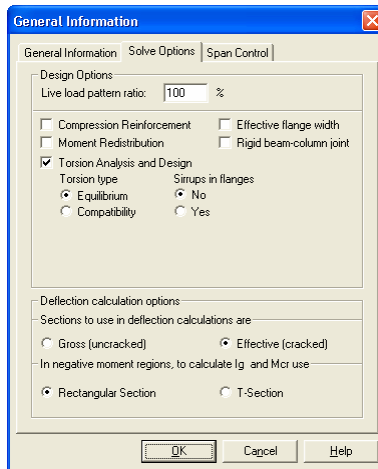

Figure 4-7 Solve Options for one-way systems

Using Span Control

The **Span Control** tab allows you to perform different operations on the spans that your system consists of. These operations include inserting new spans with default parameters, creating new spans by copying existing spans, moving spans to change span sequence, and deleting spans. The result of an operation depends on the span selected as well as on the selected support. Spans can be selected using the **Span Control List** and columns using the **Support Selection** radio buttons.

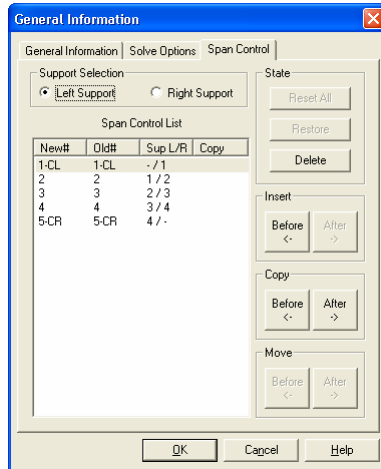

Figure 4-8 Span control tab

Additionally before the **Span Control** window is closed all changes made to the spans can be revoked using the RESET ALL button. The RESTORE button can be used to bring back a span removed using the DELETE button.

To insert a new span with default dimensions:

1. In the SPAN CONTROL LIST select the span next to which you want to insert a new span.
2. Select whether the LEFT SUPPORT or the RIGHT SUPPORT of the newly created span will be inserted.
3. Press INSERT BEFORE button to insert the new span left to the selected span or INSERT AFTER button to insert the new span on the right side of the currently selected span.

Examples of the insert operations are presented in Figure 4-9. Assuming that Span 2 is always selected the resulting systems will depend on whether

INSERT AFTER or INSERT BEFORE was used and whether LEFT COLUMN or RIGHT COLUMN was selected. Newly inserted span and column are denoted with an “x”.

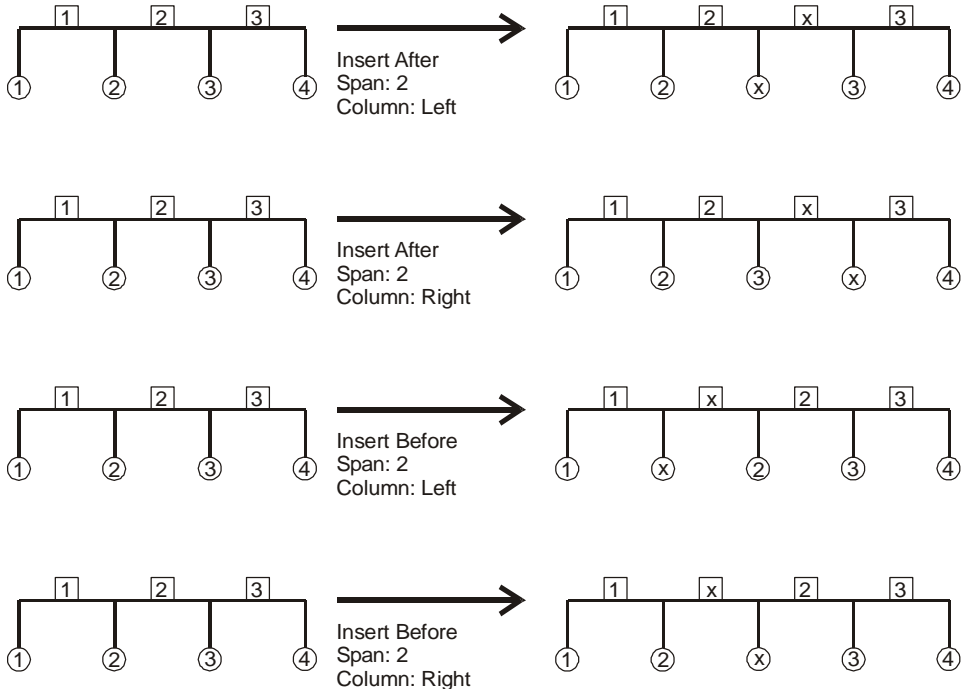

Figure 4-9 Inserting a new span using Span Control

To copy a span:

1. In the SPAN CONTROL LIST select the span you want to copy.
2. Select whether the LEFT SUPPORT or the RIGHT SUPPORT of the copied span will be copied with the span.
3. Press INSERT BEFORE button to place the copied span left to the selected span or INSERT AFTER button to place the copied span on the right side of the currently selected span.

Examples of the insert operations are presented in Figure 4-10. Assuming that Span 2 is always selected the resulting systems will depend on whether COPY AFTER or COPY BEFORE was used and whether LEFT COLUMN or RIGHT

COLUMN was selected. Newly created span and column are denoted with the prime sign.

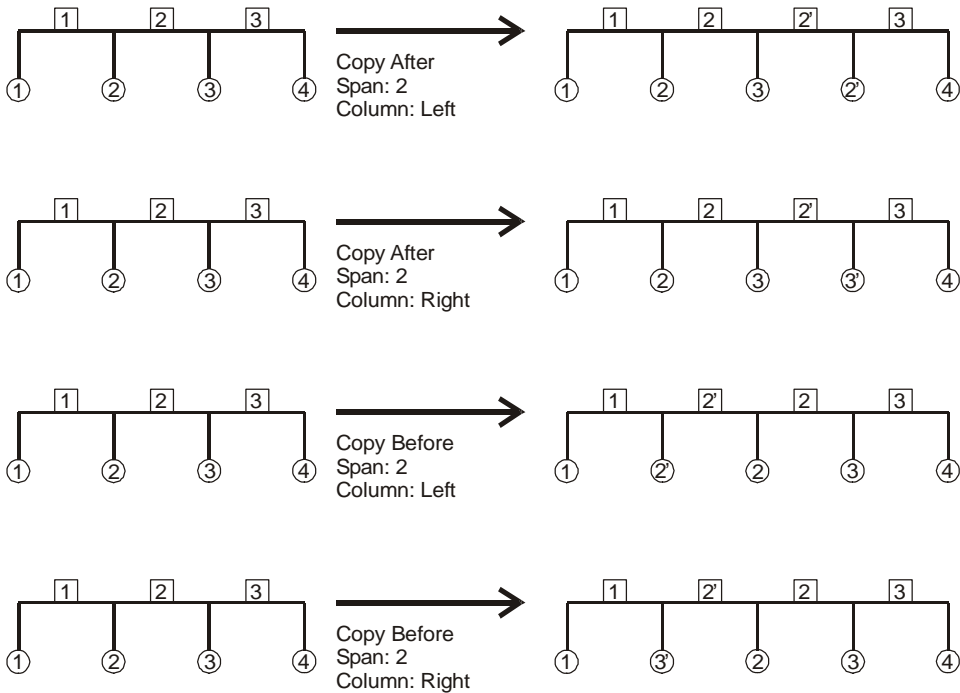

Figure 4-10 Copying a span using Span Control

To move a span:

1. In the SPAN CONTROL LIST select the span you want to move.
2. Select whether the LEFT SUPPORT or the RIGHT SUPPORT of the moved span will be moved with the span.
3. Press MOVE BEFORE button to move the span to the left or MOVE AFTER button to move the span to the right side.

Examples of the move operations are presented in Figure 4-11. Assuming that Span 2 is always selected the resulting systems will depend on whether MOVE AFTER or MOVE BEFORE was used and whether LEFT COLUMN or RIGHT COLUMN was selected.

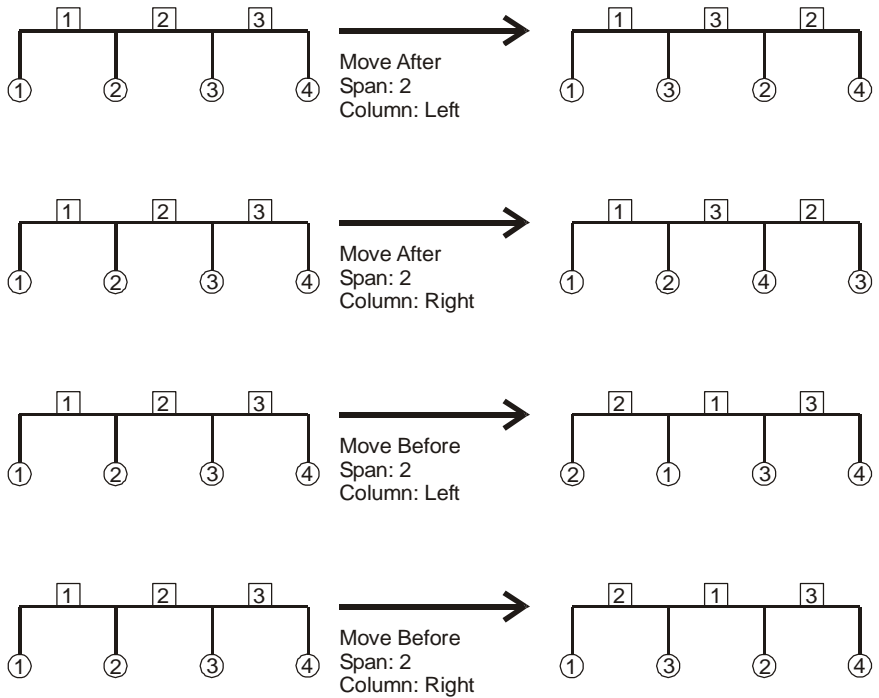

Figure 4-11 Moving a span using Span Control

To delete a span:

1. In the SPAN CONTROL LIST select the span you want to delete.
2. Select whether the LEFT SUPPORT or the RIGHT SUPPORT of the deleted span will be removed with the span.
3. Press the DELETE button to delete the selected span.

Examples of the delete operations are presented in Figure 4-12. Assuming that Span 2 is always selected the resulting systems will depend on whether LEFT COLUMN or RIGHT COLUMN was selected.

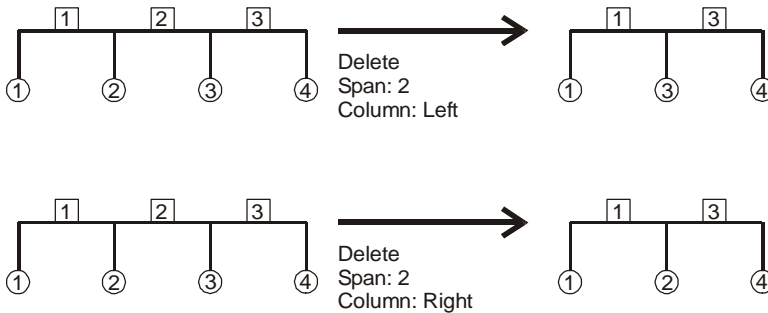



Figure 4-12 Deleting a span using Span Control

Defining Material Properties

The **Material Properties** command from the **Input** menu allows you to input material properties of the concrete and the reinforcement. There are two tabs in this dialog box. One is for concrete and the other is for reinforcing steel. This command must be executed in order to perform a design of the floor system. Use the tab key to get to each edit box then type in your values, or use your mouse and click directly on the desired tab and box, then type in your values. Refer to "Material Properties" for a detailed explanation of the default values.

To define material properties:

1. Select the **Material Properties** command from the **Input** menu or click the  button on the tool bar. The dialog box of Figure 4-13 will appear.

	Slabs and Beams	Columns	Unit
Unit density:	150	150	lb/ft ³
Comp. strength:	4	6	ksi
Young's modulus:	3834.25	4695.98	ksi
Rupture modulus:	0.4746	0.58094	ksi

Figure 4-13 Concrete Properties dialog box

2. Click the **Concrete** tab and enter the concrete density for the following members: Slabs, Beams, and Columns.
3. Enter the concrete compressive strength. By entering a value for the compressive strength, values for Young's modulus and rupture modulus will automatically be computed for the slabs, beams, and columns. Young's modulus and rupture modulus will automatically be shown in the corresponding text boxes.
4. If you have values for the rupture modulus, enter the values in the text boxes for the slabs, beams, and columns. Default values are computed based on average split tensile strength of concrete, which is calculated internally by the program. These values will be used for deflection analysis. A large value for the rupture modulus will produce a deflection analysis based on gross, non-cracked, sections. The CSA A23.3-94 Standard requires⁶⁹ that for the calculation of slab (either one-way or two-way) deflections a rupture modulus value equal to $0.6\sqrt{f'_c} / 2$ be used. pcaSlab defaults to this value of the rupture modulus for the slab concrete in CSA design runs. However, for beams rupture modulus of $0.6\sqrt{f'_c}$ has to be used and this value needs to be entered directly by the user overwriting the default value.
5. Click the **Reinforcing Steel** tab as shown in Figure 4-14.

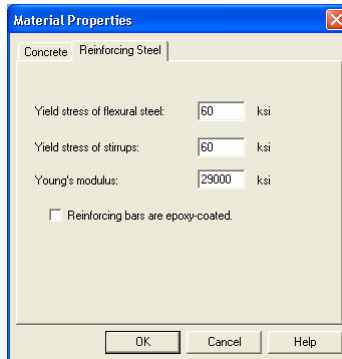

Figure 4-14 Reinforcing Steel Properties dialog box

6. Enter the yield stress of flexure steel.
7. Enter the yield stress of stirrups.

⁶⁹ CSA A23.3-94, 13.3.6

8. Enter the Young's modulus for flexural steel and stirrups.
9. Select whether the main reinforcement is epoxy-coated by clicking the left mouse button on the box or tabbing to the box and pressing the SPACE BAR. This selection affects development lengths.
10. Press OK button to exit the dialog box so that pcaSlab will use these material properties. If using the **Auto Input**, click the NEXT button to the next dialog box.

Defining the Slabs/Flanges

The **Spans** command from the **Input** menu is available for all floor systems. Span numbers, which are determined from the number of supports entered in the General Information box, are automatically filled into the **Span** drop-down list in the **Span Data** dialog box.

To input slab geometry:

1. Select the **Spans** command from the **Input** menu or click the  button on the tool bar. Click the left mouse button on the **Slabs** tab. The dialog box of Figure 4-15 will appear.
2. Select the number of the span, for which dimensions will be entered, from the **Span** drop-down list.

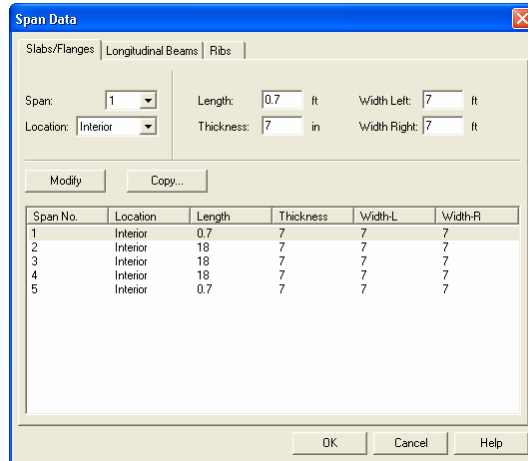

Figure 4-15 Defining the Slabs dialog box

3. Select the span location from the **Location** drop-down list. Three types of locations are available: Interior, Exterior Left, and Exterior Right. The "left"

and "right" are defined as you look along the direction of analysis. If a span has design strips on both sides it should be an "Interior" span. If a span has only a left design strip, it should be an "Exterior Right" span. If a span has only a right design strip, it should be an "Exterior Left" span.

4. Enter the slab thickness of the span.
5. Enter the span length from column centerline to column centerline or edge to column centerline for the two cantilever spans in the Length edit box. If the program detects a cantilever span length less than one-half the column dimension in the direction of analysis, an error message will pop up when the frame is analyzed. If a partial load is affected by the span length, a message warns the user of this condition.
6. Enter the span design width in the transverse direction of analysis on the left and right side of the column (see Figure 4-16). These distances are usually one-half the distance to the next transverse column or edge of the slab for exterior spans. The left and right designations are arbitrary. Both interior and exterior spans may be used in a design strip. An exterior width will automatically be designated by pcaSlab by entering a width value less than or equal to the transverse column dimension. Exterior sides do not contribute to the attached torsional stiffness, although they do contribute to loading. pcaSlab will use the total width entered for weight and superimposed loading but will use code allowed dimensions for flange width and stiffness computations.

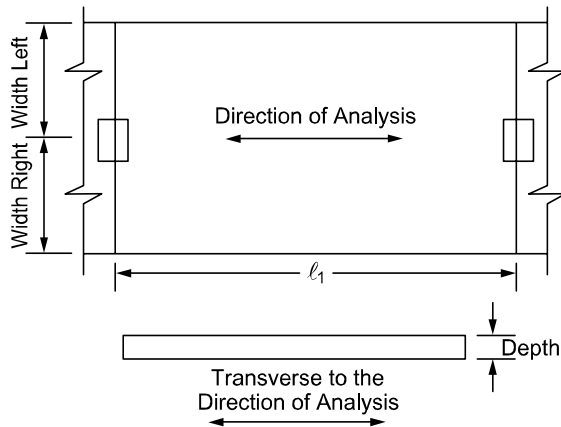

Figure 4-16 Required Slab Dimensions

7. Press the MODIFY button to update the slab geometry.

8. Repeat steps 2 through 7 until all the spans have been updated. You can use the COPY button as a shortcut.
9. Press OK button to exit the dialog box and allow pcaSlab to use the updated slab geometry.

Defining the Longitudinal Beams

Longitudinal beam dimensions are required for the beam-supported slab. Span numbers, which are determined from the number of supports entered in the General Information box, are automatically filled into the **Span** drop-down list.

To input geometry for beam-supported slab system:

1. Select the **Spans** command from the **Input** menu or click the  button on the tool bar. Click the left mouse button on the **Longitudinal Beams** tab. The dialog box of Figure 4-17 will appear.
2. Select the span number from the **Span** drop-down list.
3. Enter the width of the beam (Figure 4-18).
4. Enter the depth of the beam from the top of the slab (Figure 4-18)).
5. Press the MODIFY button to update the longitudinal beam geometry.

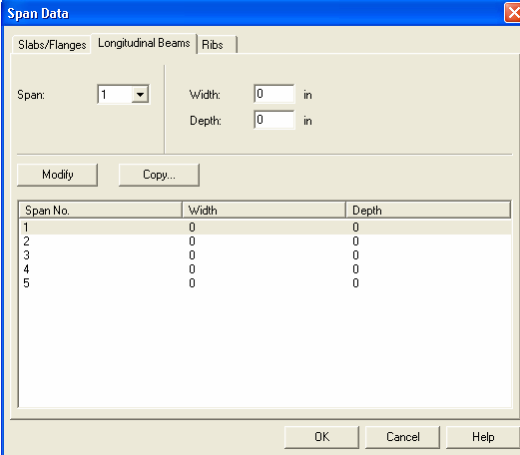

The dialog box titled "Span Data" has three tabs: "Slabs/Flanges", "Longitudinal Beams" (selected), and "Ribs". It contains input fields for "Span:" (a dropdown menu showing "1"), "Width:" (a text box with "0" and "in" unit), and "Depth:" (a text box with "0" and "in" unit). Below these are "Modify" and "Copy..." buttons. At the bottom are "OK", "Cancel", and "Help" buttons. A table is displayed with the following data:

Span No.	Width	Depth
1	0	0
2	0	0
3	0	0
4	0	0
5	0	0

Figure 4-17 Longitudinal Beam Geometry dialog box

6. Repeat steps 2 through 6 until all the beams have been updated. You can use the COPY button as a shortcut.

- Press OK button to exit the dialog box so that pcaSlab will use the new beam geometry.

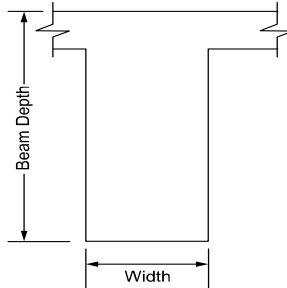



Figure 4-18 Required Longitudinal Beam Dimensions

Defining the Ribs

For the waffle slab system, you must define the rib geometry. The ribs are assumed to be the same throughout the strip.

To enter rib geometry:

- Select the **Spans** command from the **Input** menu or click the  button on the tool bar. Click the left mouse button on the **Ribs** tab. The dialog box of Figure 4-19 will appear.

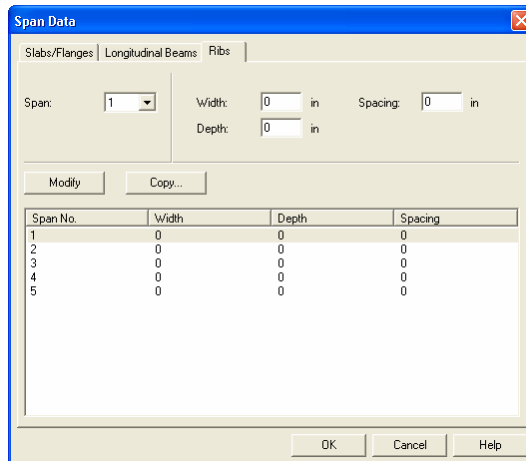

Figure 4-19 Ribs Geometry dialog box

2. Select the span number from the **Span** drop-down list.
3. Enter the spacing between ribs at the bottom for clear rib spacing (see Figure 4-20).

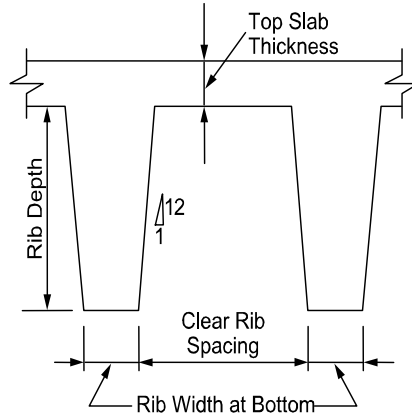



Figure 4-20 Required Rib Dimensions

4. Enter the width at the bottom for rib width (see Figure 4-20).
5. Enter the depth of the rib below the slab for Rib depth (see Figure 4-20).
6. Press OK button to exit the dialog box so that pcaSlab can use the rib geometry.

Defining the Columns

Column data is optional. If no column is specified at the joints the joint is assumed hinged. You will be allowed to enter column dimensions above and below.

To input column/capital geometry:

1. Select the **Supports** command from the **Input** menu or click the  button on the tool bar. The dialog box of Figure 4-21 will appear. Click on the **Columns** tab.
2. Enter the column height above, which is the distance from the top of the design floor to the top of the floor above (see Figure 4-21). pcaSlab obtains the clear column height above by subtracting the average slab depth from the height given. Only the slab is considered for the floor system above. A zero dimension for the column heights above and below will create a pin condition.

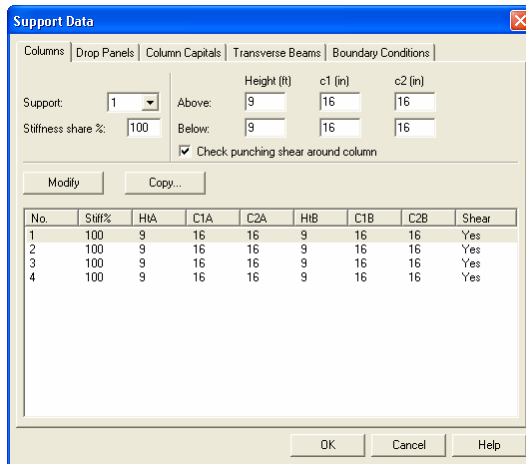

Figure 4-21 Column Geometry dialog box

- Enter the column height below, which is the distance from the design floor to the top of the floor below (see Figure 4-22). To obtain a clear column height below, the slab/drop/beam depth is subtracted from the height given. A zero dimension for the column heights above and below will create a pin condition.

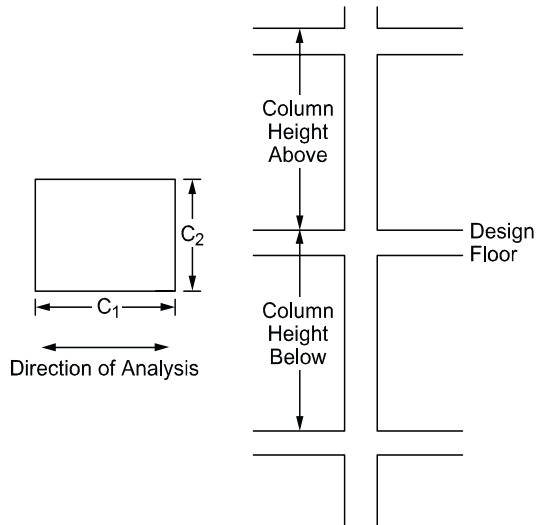

Figure 4-22 Required Column Dimensions

4. Enter a value for c_1 , the column dimension in the direction of analysis (see Figure 4-22).
5. Enter a value for c_2 , the column dimension perpendicular to the direction of analysis (see Figure 4-22). Round columns are specified with a zero input for c_2 ; c_1 is then taken as the diameter. Zero value for Stiffness Share will create a pin condition.
6. Press the MODIFY button to update the slab geometry.
7. Check the Check punching shear around column if the punching shear needs to be checked.
8. Repeat steps 2 through 7 until all the columns and capitals have been updated. You can use the COPY button as a shortcut.
9. Press OK button to exit the dialog box so that pcaSlab will use the new data.

Defining the Drop Panels

pcaSlab

Drops are only available for the flat slab or waffle slab systems and can be defined at all the support locations. The drop length and width dimensions are computed by pcaSlab, based on slab span dimensions, when the "Standard" is selected in the **Type** drop-down list.

To input drop geometry

1. Select the **Supports** command from the **Input** menu or click the  button then click on the **Drop Panels** tab. The dialog box of Figure 4-23 will appear.

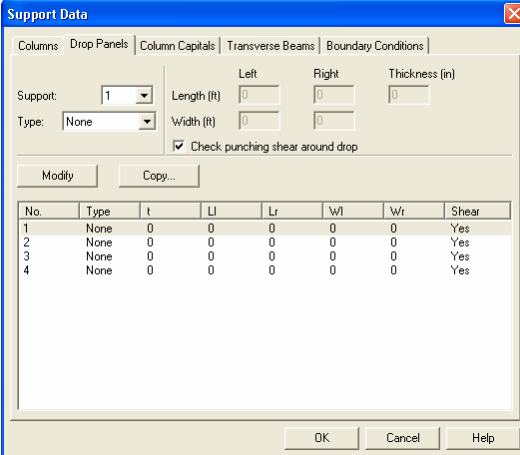

No.	Type	t	Ll	Lr	Wl	Wr	Shear
1	None	0	0	0	0	0	Yes
2	None	0	0	0	0	0	Yes
3	None	0	0	0	0	0	Yes
4	None	0	0	0	0	0	Yes

Figure 4-23 Drop Geometry dialog box

2. Select whether pcaSlab should compute the drop dimensions or the dimensions will be user specified. If pcaSlab is to compute the dimensions, the "Standard" option should be selected from the **Type** drop-down list and then only the drop depth will be available. When the "Standard drop" option is selected pcaSlab will calculate drop panel dimensions in accordance with ACI 318 Clause 13.3.7. Similar requirements contained in previous editions of the CSA A23.3 Standard have been removed from the 1994 edition. As a result, the ACI minimum specifications for drop panels are also used in CSA A23.3 runs when the "Standard Drops" option is selected. If you would like to specify drop dimensions other than those computed by pcaSlab, you must select "User-defined" from the **Type** drop-down list.
3. Enter the dimension in the direction of analysis from the column centerline to the edge of the drop left of the column (see Figure 4-24). If this is a standard drop, this dimension will not be available and the length left is set equal to the slab span length left/6 for interior columns or the left cantilever length for the first column.

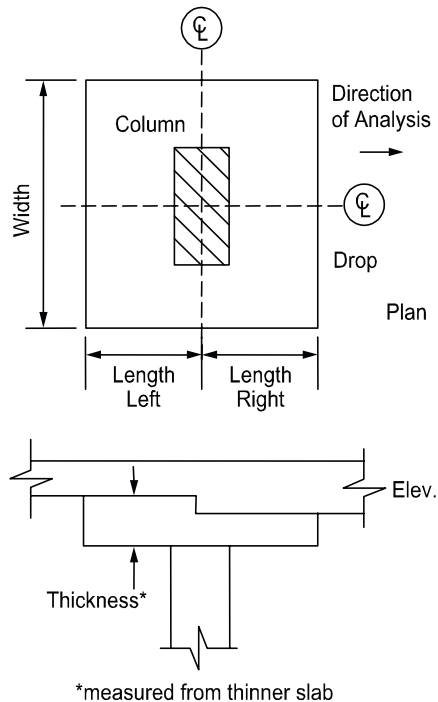



Figure 4-24 Required Drop Dimensions

4. Enter the width dimension in the transverse direction (see Figure 4-24). If this is a standard drop, this dimension will not be available and the width is set equal to slab width/3.
5. In order for pcaSlab to recognize drops, drop depths are required for the flat slab systems even if Standard Drop is selected. Enter the depth of the drop from the span with the smaller slab depth (see Figure 4-24). For waffle slab systems, the depth is automatically assumed to be equal to the rib depth below the slab and is not displayed. A value entered will be considered to exist below the rib depth during calculations.
6. Press the MODIFY button to update the drop geometry.
7. Repeat steps 2 through 6 until all the drop dimensions have been updated. You can use the COPY button as a shortcut.
8. Press OK button to exit the dialog box so that pcaSlab will use the new drop geometry.

Defining the Column Capitals

To input column capital geometry:

1. Select the **Supports** command from the **Input** menu or click the  button on the tool bar. Click left mouse button on the **Column Capitals** tab to activate it. The dialog box of Figure 4-25 will appear.

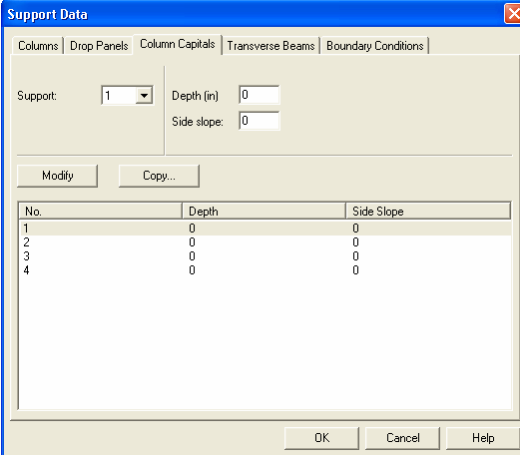

No.	Depth	Side Slope
1	0	0
2	0	0
3	0	0
4	0	0

Figure 4-25 Capital Dimensions

2. Select the support number from the **Support** drop-down list.
3. Enter the capital depth which is the distance from the bottom of the soffit (slab, drop, or beam), to the bottom of the capital.
4. The Side slope is the rate of depth to extension of the capital and it must be greater than 1 and smaller than 50 (see Figure 4-26).
5. Enter the capital extension which is the distance from the edge of the column to the end of the capital (see Figure 4-26).

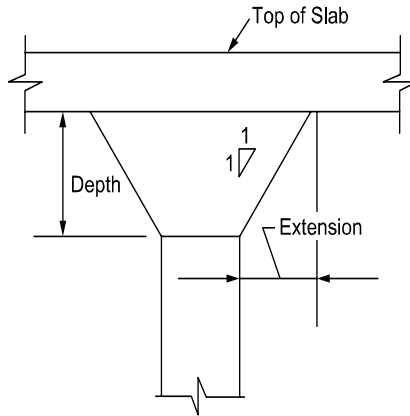

Figure 4-26 Required Capital Dimensions

Defining the Transverse Beams

The Transverse **Beam** command allows you to input the width, depth, and offset (eccentricity) of transverse beams at each column. This command is optional.

To input transverse beam geometry:

1. Select the **Support** command from the **Input** menu. Select **Transverse Beams** tab from the **Support Data** dialog box. The dialog box of Figure 4-27 will appear.
2. Enter the width of the transverse beam (see Figure 4-28)
3. Enter the depth of the transverse beam which is taken from the top of the slab to the bottom of the beam (see Figure 4-28)
4. Enter the eccentricity, which is measured from the joint centerline, positive to the right, and negative to the left of the joint (See Figure 4-28).
5. Press the MODIFY button to update the transverse beam dimensions.

- Repeat steps 2 through 5 until all the beams have been updated. You can use the COPY button as a shortcut (see "Entering the Structure Geometry" earlier in this chapter for help on the COPY button).

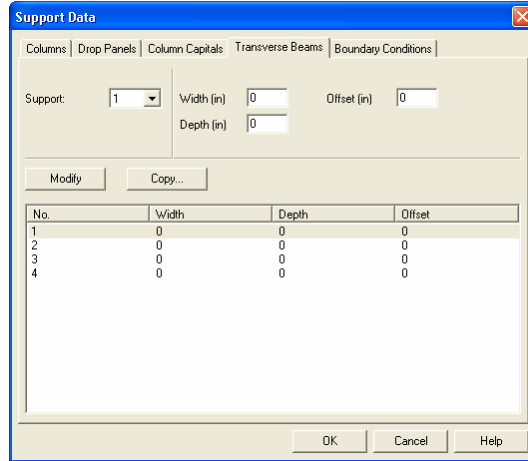

Figure 4-27 Transverse Beam Geometry dialog box

- Press OK button to exit the dialog box so that pcaSlab will use the new beam geometry.

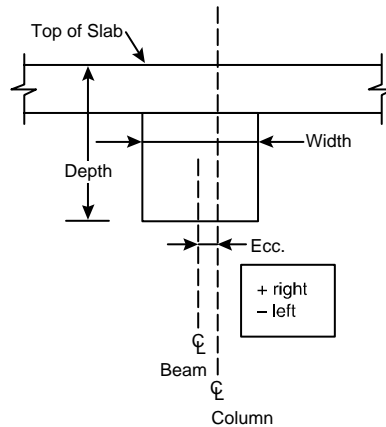

Figure 4-28 Required Transverse Beam Dimensions

Defining the Boundary Conditions

By default pcaSlab assumes that column-slab/beam joints can only rotate and that they do not undergo any translational displacements. Rotation of a joint is affected by the stiffness of elements it connects i.e. slabs/beams, transverse beams, and columns. Columns are assumed by default to be fixed at their far ends as shown in Figure 2-6. These default assumptions can be altered using the **Boundary Conditions** command.

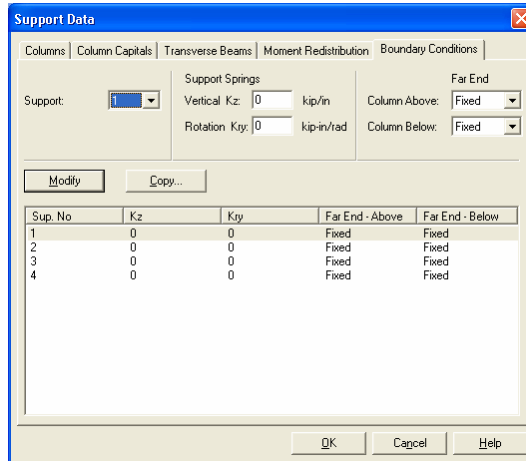

Figure 4-29 Boundary Conditions dialog box

By specifying vertical spring support constant with K_z value other than 0, you can allow the joint to displace vertically. This movement is then controlled by the stiffness of the spring K_z in addition to the stiffness of the column below. The column above is assumed not to constrain the vertical movement of the joint. Additional rotational spring support can be applied to the joint by specifying the value of K_{xy} . Also the far end column conditions can be selected as either fixed or pinned as shown in Figure 4-30 (b). All elements controlling the displacements of a joint are shown in Figure 4-30 (a).

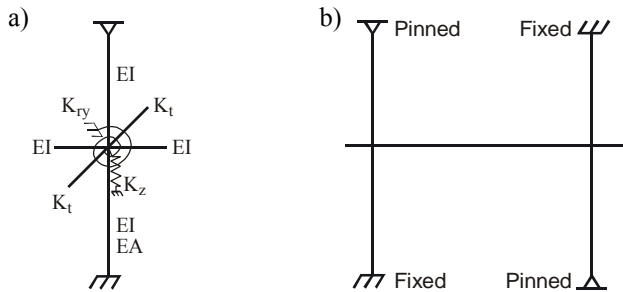

Figure 4-30 (a) Elements controlling joint displacement (b) Far End Column Boundary Conditions

To input boundary conditions:

1. Select the **Support** command from the **Input** menu. Select **Boundary Conditions** tab from the **Support Data** dialog box. The dialog box of Figure 4-29 will appear.
2. Select support number
3. Enter value of K_z to allow vertical displacement of the support and to add translational spring support (see Figure 4-30 (a))
4. Enter value of K_{xy} to add rotational spring support (see Figure 4-30 (a))
5. Select far end support conditions for the column above and below the joint (see Figure 4-30 (b))
6. Press the MODIFY button to update the boundary conditions.
7. Repeat steps 2 through 5 until all the joints have been updated. You can use the COPY button as a shortcut (see "Entering the Structure Geometry" earlier in this chapter for help on the COPY button).
8. Press OK button to exit the dialog box so that pcaSlab will use the new boundary conditions.

Defining the Moment Redistribution Factors

This command is only available for beams/one-way slab systems when MOMENT REDISTRIBUTION option is checked in the **General Information** dialog box.

To input boundary conditions:

1. Select the **Support** command from the **Input** menu. Select **Moment Redistribution** tab from the **Support Data** dialog box. The dialog box of Figure 4-31 will appear.

2. Select support number
3. Enter the maximum value of the redistribution factors you want to allow on the left and the right side of the support. Please note that actual value used is determined by the program when the problem is being solved and that the check against the code specified limit is also performed.
4. Press the MODIFY button to update the redistribution factor limits.
5. Repeat steps 2 through 5 until all the supports have been updated. Please note that supports connecting to cantilevers will not be available since moment redistribution is not allowed there. You can use the COPY button as a shortcut (see "Entering the Structure Geometry" earlier in this chapter for help on the COPY button).
6. Press OK button to exit the dialog box so that pcaSlab will use the new moment redistribution limits.

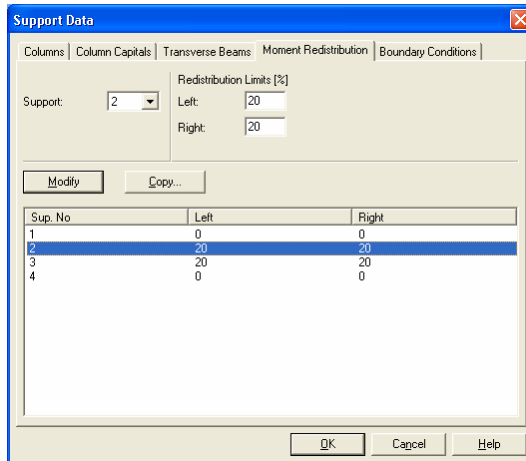



Figure 4-31 Moment Redistribution dialog box

Defining the Reinforcement Criteria for Slabs and Ribs

In order for pcaSlab to select the reinforcement, you must define the slab and rib reinforcement, bar sizes, location, and minimum spacing dimensions. See "Area of Reinforcement" and "Reinforcement Selection" in Method of Solution for a discussion of the reinforcement computations.

To define reinforcement Criteria for Slabs and Ribs:

1. Select the **Reinforcement Criteria** command from the **Input** menu or click the  button on the tool bar. Select **Slabs and Ribs** tab by clicking the left mouse button on the tab title. The dialog boxes of Figure 4-32 will appear.

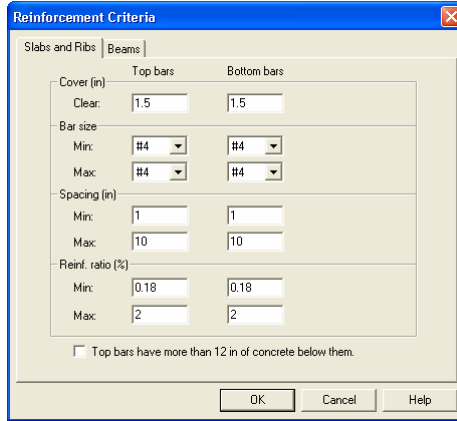

Figure 4-32 Slab and Rib Reinforcement dialog boxes

2. For slabs and ribs, enter the clear covers for top and bottom reinforcing bars. For the top reinforcement, this distance is from the top of the slab to the top of the top bars. For the bottom reinforcement, this distance is from the bottom of the slab to the bottom of the bottom bars (see Figure 4-33). The default value is 1.5 in. (40mm) for both input items.
3. Enter the minimum bar size to start the iteration for determining flexural reinforcement.
4. Enter the maximum bar size. This number will be used as a stop in the iteration for determining flexural bars in beams.
5. Enter minimum bar spacing for slab and rib flexural reinforcement. This number should be based on aggregate size or detailing considerations. Default spacing is 6 in. (150mm) for slabs and ribs.
6. Enter maximum bar spacing for slab and rib flexural reinforcement. Default spacing is 18 in. for slabs and ribs.
7. Enter minimum Reinforcement Ratio for slab and rib flexural reinforcement. Default ratio is 0.2% for slabs and ribs. If the user specified value is smaller than 0.18, 0.18 is used by pcaSlab. If the user specified value is greater than 0.18, the specified value is used by pcaSlab.

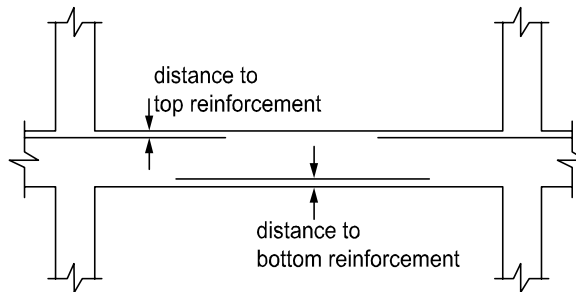

Figure 4-33 Distance to Reinforcement Edges

8. Enter maximum Reinforcement Ratio for slab and rib flexural reinforcement. Default ratio is 2% for slabs and ribs.
9. If the top bars have more than 12 in. of concrete below them, check the corresponding check box.
10. Press OK button to exit the dialog box and allow pcaSlab to use the new data.

Defining the Reinforcement Criteria for Beams

In order for pcaSlab to select the reinforcement, you must define the beam reinforcement, bar sizes, location, and minimum spacing dimensions. See "Area of Reinforcement" and "Reinforcement Selection" in the Method of Solution for a discussion of the reinforcement computations.

To define reinforcement criteria for beams:

1. Select the **Reinforcement Criteria** command from the **Input** menu or click the % button on the tool bar. Select **Beams** tab by clicking the left mouse button on the tab title. The dialog boxes of Figure 4-34 will appear.
2. Enter the covers for top and bottom reinforcing bars for beams. For the top reinforcement, this distance is from the top of the slab to the centroid of the top bars; and for the bottom reinforcement, this distance is from the bottom of the slab to the bottom of the bottom bars (see Figure 4-35). The default value is 1.5 in. (40mm) for both input items.
3. Enter the minimum bar size for top and bottom bars and stirrups to start the iteration for determining flexural reinforcement.
4. Enter the maximum bar size for top and bottom bars and stirrups. This number will be used as a stop in the iteration for determining flexural bars in beams.
5. Enter the minimum bar spacing for beam flexural reinforcement and stirrups. This number should be based on aggregate size or detailing considerations.

The default minimum reinforcement bar spacing is 2 in. and the default stirrup spacing is 6 in.

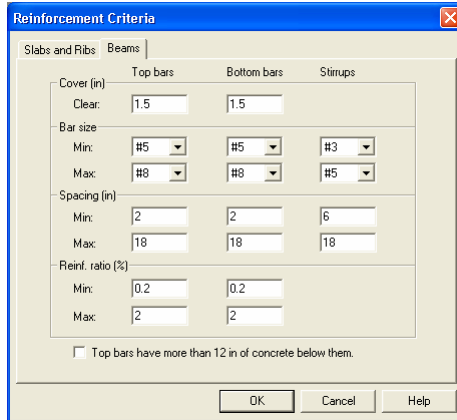

Figure 4-34 Reinforcement dialog boxes

6. Enter the maximum bar spacing for beam flexural reinforcement and stirrups. The default maximum reinforcement spacing is 18 in. and the default maximum stirrup spacing is 18 in.
7. Enter the minimum Reinforcement Ratio for beam flexural reinforcement. Default ratio is 0.2% for beams. If the user specified value is smaller than 0.2, 0.2 is used by pcaSlab. If the user specified value is greater than 0.2, the specified value is used by pcaSlab.

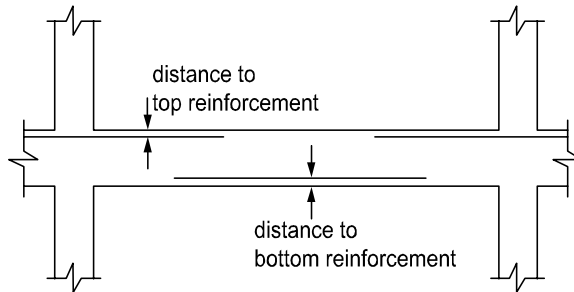

Figure 4-35. Distance to Reinforcement

8. Enter the maximum Reinforcement Ratio for beam flexural reinforcement. Default ratio is 2% for slabs and ribs.

9. If the top bars have more than 12 in. of concrete below them, check the corresponding check box.
10. Press OK button to exit the dialog box and allow pcaSlab to use the new data.

Defining Column Strip Bars for Two-Way Slab Systems



The reinforcing bar size, number of bars, bar length, etc. can be defined by users if the Run Mode of Investigation and two-way floor system are selected in the General Information dialog box. This menu item is not available if Run Mode of Design is selected in the **General Information** dialog box.

To define column strip bars:

1. Select **Reinforcing Bars** from the **Input** menu or click the  button on the tool bar. Select the **Column Strip Bars** tab by clicking the tab title or use the tab key on the keyboard to toggle to the tab title then select the Column Strip Bars tab using the arrow keys. The dialog boxes of Figure 4-36 will appear.

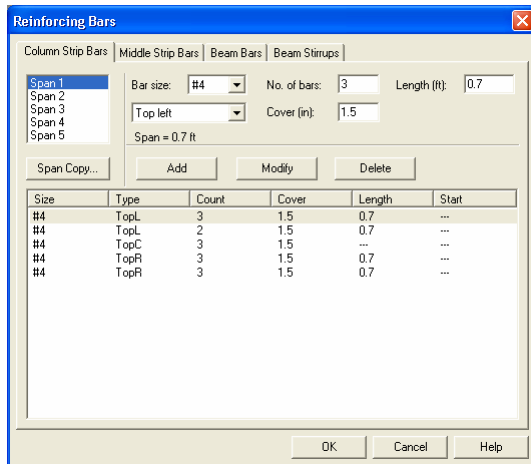

Figure 4-36 Defining Column Strip Bars

2. Select the span for which reinforcing bars will be defined from the Span list box on the upper left corner. The length of the selected span will be shown right above the ADD button.
3. Select bar size from the **Bar Size** drop-down list.
4. Define the number of reinforcing bars in the selected span by entering the number in the Number of Bars input box.

5. Define the length of the reinforcing bars by entering the length in the Length input box. The unit of the length is foot [m].
6. Define the types of the reinforcing bars in the selected span by selecting from the **Type** drop-down list, which is right below the **Bar Size** drop-down list. Five types are available: Top Left, Top Right, Top Continuous, Bottom Continuous and Bottom Discontinuous.
7. Define the cover by entering the number in the Cover input box. The unit of cover is inch [mm].
8. Press ADD button to add the new data into the list box below the buttons.
9. Repeat steps 2 to 8 to define reinforcing bars for all the spans. You may use the SPAN COPY button below the Span list to simply copy the data of one span to other spans.
10. If the reinforcing data of a span needs to be modified, select the data from the data list box on the lower part of the dialog box then modify the data as mentioned above. Press MODIFY button when finished to update the corresponding data in the data list box.
11. To delete the reinforcing data for a span, select the data of the span from the data list box then press the DELETE button.
12. Press OK button to exit the dialog box so that pcaSlab will use these reinforcing bar properties.

Defining Middle Strip Bars for Two-Way Slab Systems



The reinforcing bar size, number of bars, bar length, etc., can be defined by users if the Run Mode of Investigation and two-way floor system are selected in the General Information dialog box. This menu item is not available if **Run Mode of Design** is selected in the **General Information** dialog box.

To define middle strip bars:

1. Select **Reinforcing Bars** from the **Input** menu or click the  button on the tool bar. Select the **Middle Strip Bars** tab by clicking the tab title or use the tab key on the keyboard to toggle to the tab title then select the **Middle Strip Bars** tab using the arrow keys. The dialog boxes of Figure 4-37 will appear.

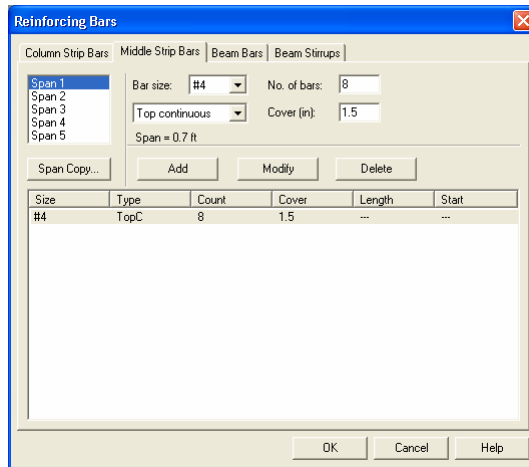

Figure 4-37 Defining Middle Strip Bars

2. Select the span for which reinforcing bars will be defined from the Span list box on the upper left corner. The length of the selected span will be shown right above the ADD button.
3. Select bar size from the **Bar Size** drop-down list.
4. Define the number of reinforcing bars in the selected span by entering the number in the Number of Bars input box.
5. Define the length of the reinforcing bars by entering the length in the Length input box. The unit of the length is foot [m].
6. Define the Types of the reinforcing bars in the selected span by selecting from the drop-down list, which is right below the **Bar Size** drop-down list. Five types are available: Top Left, Top Right, Top Continuous, Bottom Continuous and Bottom Discontinuous.
7. Define the cover by entering the number in the Cover input box. The unit of cover is inch [mm].
8. Press ADD button to add the new data into the list box below the buttons.
9. Repeat steps 2 to 8 to define reinforcing bars for all the spans. You may use the SPAN COPY button below the Span list to simply copy the data of one span to other spans.
10. If the reinforcing data of a span needs to be modified, select the data from the data list box on the lower part of the dialog box then modify the data as

mentioned above. Press **MODIFY** button when finished to update the corresponding data in the data list.

11. To delete the reinforcing data for a span, select the data of the span from the data list box then press the **DELETE** button.
12. Press **OK** button to exit the dialog box so that pcaSlab will use these reinforcing bar properties.

Defining Beam Bars for Two-Way Slab Systems

pcaSlab

The reinforcing bar size, number of bars, bar length, etc. can be defined by users if the **Run Mode of Investigation** and two-way floor system are selected in the **General Information** dialog box. This menu item is not available if **Run Mode of Design** is selected in the **General Information** dialog box.

To define beam bars:

1. Select **Reinforcing Bars** from the **Input** menu or click the  button from the tool bar. Select the **Beam Bars** tab by clicking the tab title or use the tab key on the keyboard to toggle to the tab title then select the **Beam Bars** tab using the arrow keys. The dialog boxes of Figure 4-38 will appear.

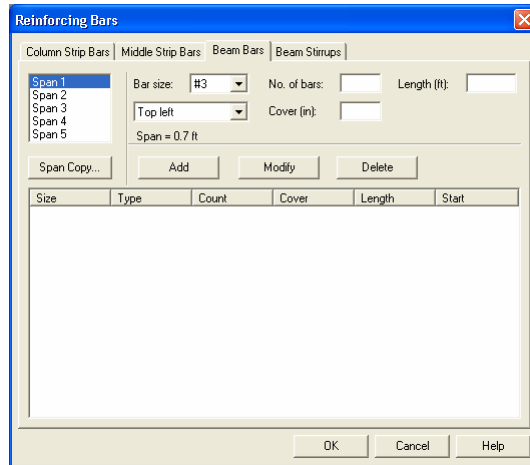

Figure 4-38 Defining Beam Bars

2. Select the span for which reinforcing bars will be defined from the **Span** list box on the upper left corner. The length of the selected span will be shown right above the **ADD** button.
3. Select bar size from the **Bar Size** drop-down list.

4. Define the number of reinforcing bars in the selected span by entering the number in the Number of Bars input box.
5. Define the length of the reinforcing bars by entering the length in the Length input box. The unit of the length is foot [m].
6. Define the types of the reinforcing bars in the selected span by selecting from the **Type** drop-down list, which is right below the **Bar Size** drop-down list. Five types are available: Top Left, Top Right, Top Continuous, Bottom Continuous and Bottom Discontinuous.
7. Define the cover by entering the number in the Cover input box. The unit of cover is inch [mm].
8. Press ADD button to add the new data into the list box below the buttons.
9. Repeat steps 2 to 8 to define reinforcing bars for all the spans. You may use the SPAN COPY button below the Span list to simply copy the data of one span to other spans.
10. If the reinforcing data of a span needs to be modified, select the data from the data list box on the lower part of the dialog box then modify the data as mentioned above. Press MODIFY button when finished to update the corresponding data in the data list.
11. To delete the reinforcing data for a span, select the data of the span from the data list box then press the DELETE button.
12. Press OK button to exit the dialog box so that pcaSlab will use these reinforcing bar properties.

Defining Beam Stirrups for Two-Way Slab Systems

The stirrup size, number of stirrups, etc. can be defined by users if the Run Mode of Investigation and two-way floor system are selected in the **General Information** dialog box. This menu item is not available if **Run Mode** of **Design** is selected in the **General Information** dialog box.

To define beam stirrups:

1. Select **Reinforcing Bars** from the **Input** menu or click the  button from the tool bar. Select the **Beam Stirrups** tab by clicking the tab title or use the tab key on the keyboard to toggle to the tab title then select the **Beam Stirrups** tab using the arrow keys. The dialog boxes of Figure 4-39 will appear.

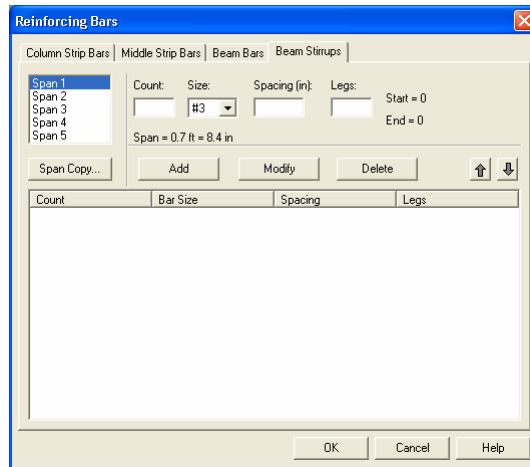

Figure 4-39 Defining Beam Stirrups

2. Select the span for which stirrups will be defined from the **Span** list box on the upper left corner. The length of the selected span will be shown right above the ADD button.
3. Enter the amount of stirrups of the selected span in the Count input box. (see Note)
4. Select stirrup size from the **Size** drop-down list.
5. Enter the spacing of the stirrups of the selected span in the Spacing input box. The unit of spacing is inch [mm].
6. Enter the number of legs in the Leg input box.
7. Press ADD button to add the new data into the list box below the buttons.
8. Repeat steps 2 to 8 to define stirrups for all the spans. You may use the Span COPY button below the Span list to simply copy the data of one span to other spans.
9. If the stirrup data of a span needs to be modified, select the data from the data list box on the lower part of the dialog box then modify the data as mentioned above. Press MODIFY button when finished to update the corresponding data in the data list.
10. To delete the stirrup data for a span, select the data of the span from the data list box then press the DELETE button.
11. Press OK button to exit the dialog box so that pcaSlab will use these reinforcing bar properties.

Note: If stirrups do not apply in a part of a span, the Count should be set to 0 (zero) and the Spacing should be the length of the part of the span where no stirrups are defined. For example, the following configuration shows stirrups in the left and right ends of a span with an empty space (46.0 in. long, no stirrups) in the middle part of the span.

Count	Bar Size	Spacing	Legs
32	#5	4.50	2
0	#5	46.0	2
32	#5	4.50	2

Defining Flexure Bars for Beams and One-Way Slab Systems

The reinforcing bar size, number of bars, bar length, etc. for one-way beam systems can be defined by users if the Run Mode of Investigation and beams/one-way slab floor system are selected in the **General Information** dialog box. This menu item is not available if **Run Mode** of **Design** is selected in the **General Information** dialog box.

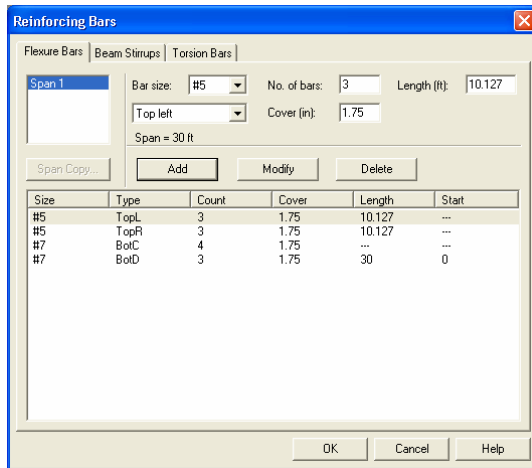

Figure 4-40 Defining Flexure Bars for Beams/One-Way slab Systems

To define flexure bars for beam in beams/one-way slab systems follow the steps described in section Defining Beam Bars.

Defining Stirrups for Beams and One-Way Slab Systems

The stirrup size, number of stirrups, etc. for beams/one-way slab systems can be defined by users if the Run Mode of Investigation and beams/one-way slab floor system are selected in the **General Information** dialog box. This menu item is not available if **Run Mode** of **Design** is selected in the **General Information** dialog box.

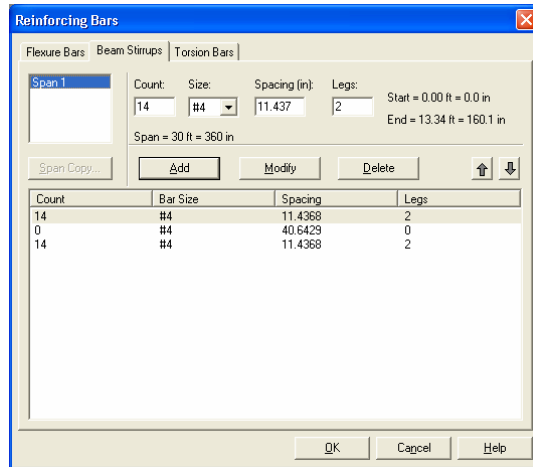



Figure 4-41 Defining Beams Stirrups in Beams/One-Way Slab Systems

To define beam stirrups in beams/one-way slab systems follow the steps described in section Defining Beam Stirrups.

Defining Torsional Longitudinal Bars for Beams

The torsional longitudinal reinforcement bars are distributed along the perimeter of the section in addition to the flexure bars. They can be defined by users if the Run Mode of Investigation, beams/one-way slab floor system, and torsional analysis and design are selected in the **General Information** dialog box. This menu item is not available if **Run Mode** of **Design** is selected in the **General Information** dialog box.

To define torsional longitudinal bars for beams in beams/one-way slab systems:

1. Select **Reinforcing Bars** from the **Input** menu or click the  button from the tool bar. Select the **Torsion Bars** tab by clicking the tab title or use the tab key on the keyboard to toggle to the tab title then select the **Torsion Bars** tab using the arrow keys. The dialog boxes of Figure 4-42 will appear.

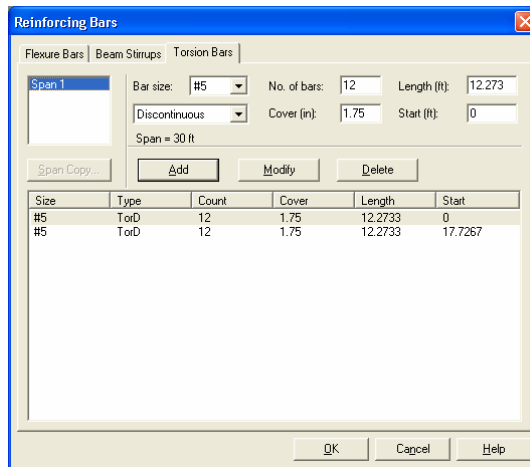

Figure 4-42 Defining Torsion Bars for Beams in Beams/One-Way Slab Systems

2. Select the span for which reinforcing bars will be defined from the **Span** list box on the upper left corner. The length of the selected span will be shown right above the ADD button.
3. Select bar size from the **Bar Size** drop-down list.
4. Define the type of the reinforcing bars in the selected span by selecting from the **Type** drop-down list, which is right below the **Bar Size** drop-down list. Two types are available: Continuous and Discontinuous.
5. Define the number of reinforcing bars in the selected span by entering the number in the Number of Bars input box.
6. Define the cover by entering the number in the Cover input box. The unit of cover is inch [mm].
7. For discontinued bars, define the length and the starting point of the reinforcing bars by entering the values in the Start and Length input boxes. The unit of both is foot [m].
8. Press ADD button to add the new data into the list box below the buttons.
9. Repeat steps 2 to 8 to define reinforcing bars for all the spans. You may use the SPAN COPY button below the Span list to simply copy the data of one span to other spans.
10. If the reinforcing data of a span needs to be modified, select the data from the data list box on the lower part of the dialog box then modify the data as

mentioned above. Press **MODIFY** button when finished to update the corresponding data in the data list.

11. To delete the reinforcing data for a span, select the data of the span from the data list box then press the **DELETE** button.
12. Press **OK** button to exit the dialog box so that pcaSlab will use these reinforcing bar properties.

Defining Load Cases

Up to 6 load cases of dead load, live load or lateral load can be defined in the **Load Cases** dialog box. The default five load case labels (types) are SELF (dead load), Dead (dead load), Live (live load), Wind (wind load), and EQ (seismic load).

To define load cases:

1. Select **Load Cases** command from the **Input** menu or click the  button on the tool bar. Dialog box as in Figure 4-43 will appear.

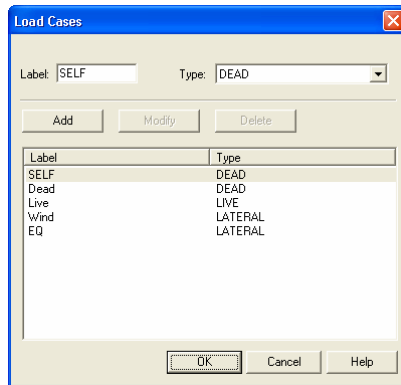

Figure 4-43 Defining Load Cases

2. Enter a name for the new load case in the Label edit box. The name could be any character string defined by the user.
3. Select the type of the new load case from the **Type** drop-down list. The available types are Dead Load, Live Load and Lateral Load.
4. Press **ADD** button to add the new load case into the load case list box on the lower part of the dialog box.

5. Repeat steps 2 to 4 to define all the load cases. The maximum number of load cases is 6. Once the maximum number is reached, the ADD button will be disabled.
6. To modify an existing load case, select the load case from the load case list box then change the label or type the selected load case as mentioned above and press the MODIFY button.
7. To delete an existing load case, select the load case from the load case list box then press the DELETE button.
8. Press OK button to exit the dialog box so that pcaSlab will use these load cases.

Note: Only one case of live load can be defined. Load case label must be unique for each of the load cases.

Defining Load Combinations

pcaSlab allows you to change the magnification factors applied to the load cases. The default values depend on the code selected with the General Information command.

To define load factors:

1. Select **Load Combinations** from the **Input** menu or click the  button from the tool bar. The dialog box of Figure 4-44 will appear if the ACI code was selected in the GENERAL INFORMATION dialog box.

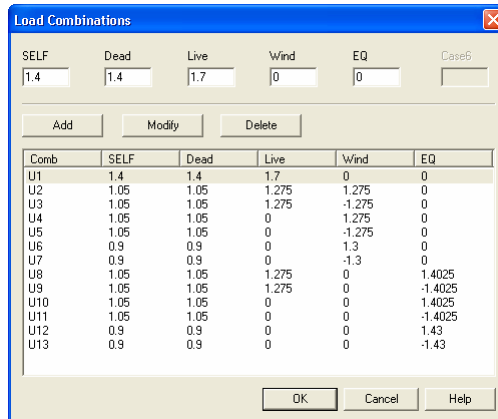

Figure 4-44 Define Load Combinations

2. The load cases and the corresponding factors that are defined in the Load Cases dialog box are shown on the top of the Load Combinations dialog box.
3. Enter the load factors for each of the load cases in the input box below the corresponding load case label.
4. Press the ADD button to add the combination defined above into the big list box in the lower part of the dialog box.
5. Repeat steps 2 to 4 to define all the load combinations. Up to twenty load combinations may be defined. All the combinations are indexed automatically from U1 to U20.
6. To change the factors of an existing combination, select the load combination from the load combination list box on the lower part of the dialog box then change the factors as mentioned above. Press the MODIFY button when finished to update the data in the load combination list box.
7. To delete an existing combination, select the load combination from the load combination list box then press the DELETE button.
8. Select OK button when all the desired load factors have been modified to exit so that pcaSlab will use the new data.

Span Loads

pcaSlab computes the self weight of the floor system. Other loads applied to the structure have to be specified by the user. There are several types of applied loads that may be entered. They are found in the **Input** menu. Surface loads are placed over the entire strip. Partial loads consist of uniform or trapezoidal loads, concentrated loads, and concentrated moments that may exist anywhere within the span length. For beams/one-way slab systems torsional loads can be defined either as concentrated or distributed torques.

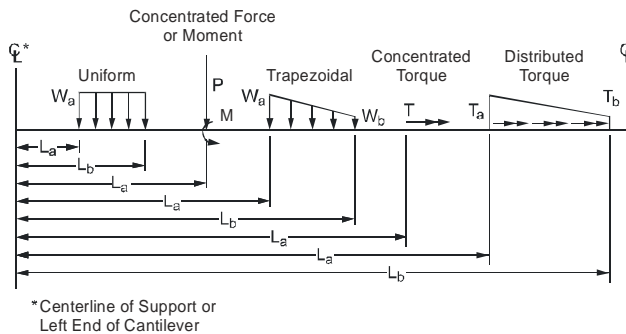

Figure 4-45 Span Load Types

Note: The loads shown in the Figure 4-45 are all positive and may not match the typical sign conventions.

The following table describes input for the span load types shown in Figure 4-45.

W_a	<p>For uniformly distributed loads, W_a is the intensity of the load in units of lbs/ft [kN/m], positive W_a is downward. For trapezoidal loads, W_a is the intensity at the left end in units of lbs/ft [kN/m], positive W_a is downward. For concentrated force, W_a is the force P in units of kips [kN], positive W_a is downward. For concentrated moments, W_a is the moment M in units of ft-kips [kN-m], positive W_a is clockwise. For concentrated torque, W_a is the external torque T in units of ft-kips [kN-m], positive W_a is such that applying the right hand screw rule the torque vector points to the right. For distributed torque, W_a is the external torque intensity T_a in units of ft-kips/ft [kN-m/m], positive W_a is such that applying the right hand screw rule the torque vector points to the right.</p>
W_b	<p>For trapezoidal loads, W_b is the intensity at the right end in units of lbs/ft [kN/m], positive W_b is downward. For distributed torque, W_b is the external torque intensity T_b in units of ft-kips/ft [kN-m/m], positive W_a is such that applying the right hand screw rule the torque vector points to the right. For all the other partial load types, W_b is not available.</p>
L_a	<p>For distributed loads, L_a is the distance where the load begins from the centerline of the column at the left of the span, in units of ft [m]. For concentrated loads and moments, L_a is the distance where the load exists from the centerline of the column at the left of the span in units of ft [m].</p>
L_b	<p>For distributed loads, L_b is the distance where the load ends from the centerline of the column at the left of the span, in units of ft [m]. For concentrated loads and moments, L_b is unavailable.</p> <p>Note: Although the particular loading may not actually act over the entire transverse width, all line loading is converted internally by pcaSlab to act over the full width of the slab. In the design direction, partial loads given as acting over less than 1/20 of the span length will be averaged over 1/20 by the program.</p>

Defining Area Load on Span

Area loads are uniform loads acting over the entire strip. These loads have units of lb/ft² [kN/m²].

To input area loads:

1. Select the **Span Loads** command from the **Input** menu or click the  button on the tool bar. Select the AREA LOAD from the TYPE drop-down list on the SPAN LOADS dialog box. The dialog box of Figure 4-46 will appear.

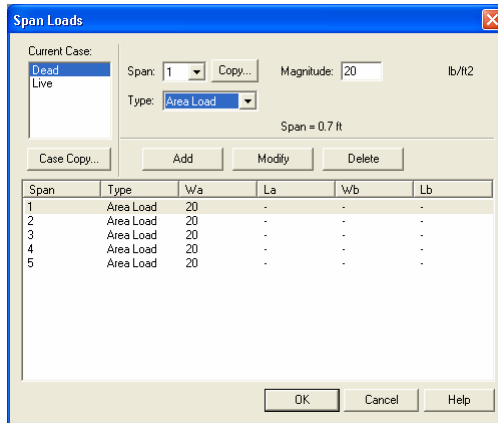

Figure 4-46 Defining Area Load on Span

2. Select the load case from the CURRENT CASE list box on the upper left corner as shown in the dialog above.
3. Select the span on which the area loads will be applied from the SPAN drop-down list.
4. Enter the un-factored superimposed area load magnitude acting over the entire area of the strip in the Magnitude edit box. Positive surface loads act downward.
5. Press the ADD button to update the area loads in the area load list box on the lower part of the dialog box.
6. Repeat steps 2 through 5 until the loads have been updated. You can use the COPY button as a shortcut.
7. To change the data of an existing area load, select the area load from the area load list box then change the magnitude as mentioned above. Press the MODIFY button when finished to update the data in the area load list box.

8. To delete an existing area load, select the load from the area load list box then press the DELETE button.
9. Press OK button to exit the dialog box so that pcaSlab will use the new data.

Defining Line Load on Span

You may enter uniform or trapezoidal loads that do not span from column centerline to column centerline in the direction of analysis. These loads are called line loads and are input through the SPAN LOADS dialog of the **Input** menu. Partial loads are assumed to act over the entire strip width.

To input line loads:

1. Select the **Span Loads** command from the **Input** menu or click the  button on the tool bar. Select the LINE LOAD from the TYPE drop-down list. The dialog box of Figure 4-47 will appear.

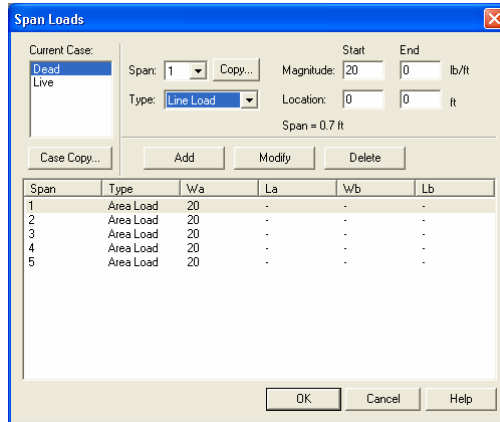

Figure 4-47 Defining Line Load on Span

2. Select the load case of the line load that will be defined from the **Current Case** list box.
3. From the **Span** drop-down list, select the span number of the span whose line loads you would like to input.
4. Define un-factored load values and their locations in the corresponding text boxes.
5. Select **Add** to add the line load defined into the line load list box.
6. Repeat steps 2 through 5 until all the line loads have been entered then press OK button to exit the dialog box so that pcaSlab will use the new loads.

To change line loads data:

1. Select the line load you want to change from the line load list box on the lower part of the dialog box by clicking the left mouse button on the load or tabbing to the list box and using the arrow up and down keys.
2. Make your changes to the load by modifying the load type, the load magnitude, and/or location.
3. Select **Modify** to replace the old data with the new data.

To delete line load data:

1. Select the line load you want to delete from the line load list box by clicking the left mouse button on the load or tabbing to the list box and using the arrow up and down keys.
2. Press the DELETE button.

Defining Point Force on Span

You may enter concentrated vertical loads. These loads are input through the **Span Load** command of the **Input** menu. Point loads are assumed to act over the entire strip width.

To input point loads:

1. Select the **Span Loads** command from the **Input** menu or click the  button on the tool bar. Select the **Point Force** from the **Type** drop-down list. The dialog box of Figure 4-48 will appear.

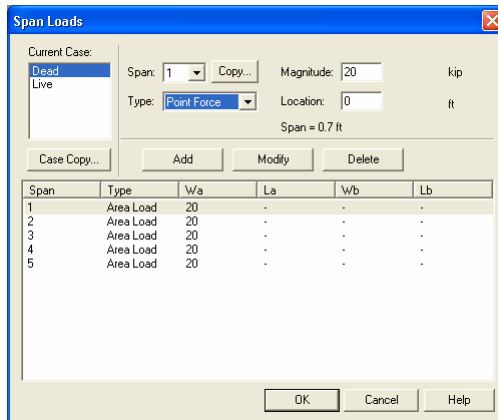

Figure 4-48 Defining Point Forces on Span

2. Select the load case of the point force that will be defined from the **Current Case** list box.
3. From the **Span** drop-down list, select the span number of the span whose point loads you would like to input.
4. Define un-factored load values and their locations in the corresponding text boxes.
5. Select **Add** to add the point load defined into the point load list box on the lower part of the dialog box.
6. Repeat steps 2 through 5 until all the point loads have been entered then press OK button to exit the dialog box so that pcaSlab will use the new loads.

To change point load data:

1. Select the point force you want to change from the point load list box by clicking the left mouse button on the load or tabbing to the list box and using the arrow up and down keys.
2. Make your changes to the load by modifying the load type, the load magnitude, and/or location.
3. Select **Modify** to replace the old data with the new data.

To delete point load data:

1. Select the point force you want to delete from the point load list box to the right by clicking the left mouse button on the load or tabbing to the list box and using the arrow up and down keys.
2. Press the DELETE button.

Defining Point Moment on Span

You may enter concentrated moment. This load is input through the **Span Load** command of the **Input** menu. Point moments are assumed to act over the entire strip width.

To input point moments:

1. Select the **Span Loads** command from the **Input** menu or click the  button on the tool bar. Select the **Point Moment** from the **Type** drop-down list. The dialog box of Figure 4-49 will appear.

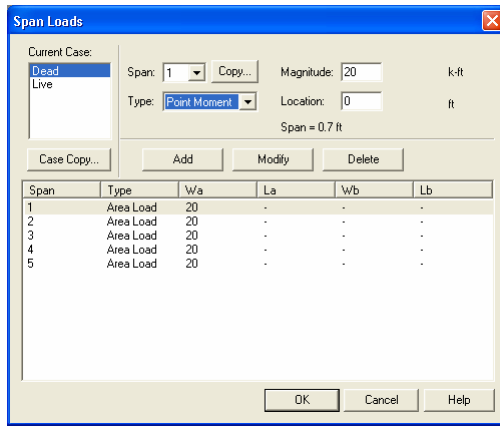

Figure 4-49 Defining Point Moments on Span

2. Select the load case of the point moment that will be defined from the **Current Case** list box.
3. From the **Span** drop-down list, select the span number of the span whose point moments you would like to input.
4. Define un-factored moment values and their locations in the corresponding text boxes.
5. Select **Add** to add the point moment defined into the point moment list box on the lower part of the dialog box.
6. Repeat steps 2 through 5 until all the point moments have been entered then press OK button to exit the dialog box so that pcaSlab will use the new moments.

To change point load data:

1. Select the point moment you want to change from the point moment list box by clicking the left mouse button on the load or tabbing to the list box and using the arrow up and down keys.
2. Make your changes to the moment by modifying the moment type, the moment magnitude, and/or location.
3. Select **Modify** to replace the old data with the new data.

To delete point load data:

1. Select the point moment you want to delete from the point moment list box to the right by clicking the left mouse button on the load or tabbing to the list box and using the arrow up and down keys.
2. Press the DELETE button.

Defining Line Torque on Span

You may enter line torque for beams/one-way slab systems if Torsion Analysis and Design is selected in the GENERAL INFORMATION dialog box. This load is input through the **Span Load** command of the **Input** menu.

To input line loads:

1. Select the **Span Loads** command from the **Input** menu or click the  button on the tool bar. Select the LINE TORQUE from the TYPE drop-down list. The dialog box of Figure 4-50 will appear.

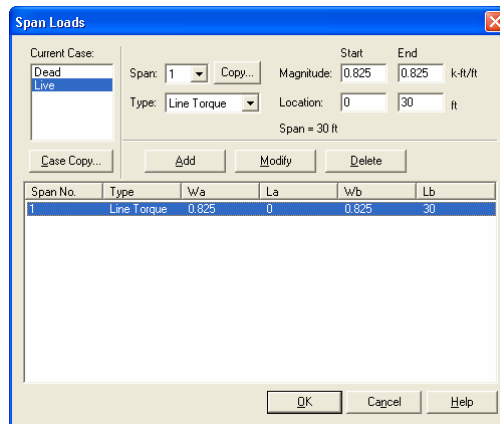

Figure 4-50 Defining Line Torque on Span

2. Select the load case of the line load that will be defined from the CURRENT CASE list box.
3. From the SPAN drop-down list, select the span number of the span whose line loads you would like to input.
4. Define un-factored torque values and their locations in the corresponding text boxes.
5. Select **Add** to add the line torque defined into the list box.

6. Repeat steps 2 through 5 until all the line torques have been entered. Then press OK button to exit the dialog box so that pcaSlab will use the new loads.

To change line torque data:

1. Select the line torque you want to change from the load list box on the lower part of the dialog box by clicking the left mouse button on the load or tabbing to the list box and using the arrow up and down keys.
2. Make your changes to the load by modifying the load type, the load magnitude, and/or location.
3. Select **Modify** to replace the old data with the new data.

To delete line torque data:

1. Select the line torque you want to delete from the load list box by clicking the left mouse button on the load or tabbing to the list box and using the arrow up and down keys.
2. Press the DELETE button.

Defining Point Torque on Span

You may enter point torque for beams/one-way slab systems if Torsion Analysis and Design is selected in the GENERAL INFORMATION dialog box. This load is input through the **Span Load** command of the **Input** menu.

To input point torque:

1. Select the **Span Loads** command from the **Input** menu or click the  button on the tool bar. Select the POINT TORQUE from the TYPE drop-down list. The dialog box of Figure 4-51 will appear.
2. Select the load case of the point torque that will be defined from the CURRENT CASE list box.
3. From the SPAN drop-down list, select the span number of the span whose point moments you would like to input.
4. Define un-factored torque values and their locations in the corresponding text boxes.
5. Select ADD to add the point torque defined into the list box on the lower part of the dialog box.
6. Repeat steps 2 through 5 until all the point torques have been entered. Then press OK button to exit the dialog box so that pcaSlab will use the new torques.

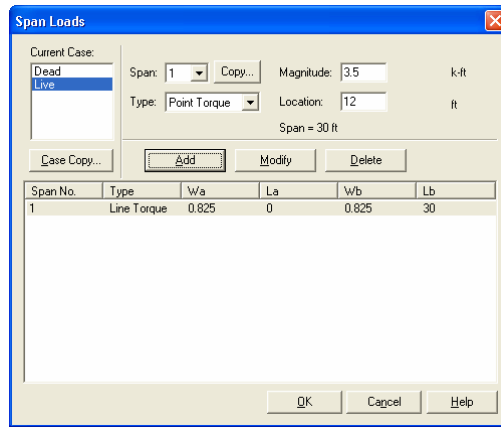

Figure 4-51 Defining Point Torque on Span

To change point torque data:

1. Select the point torque you want to change from the list box by clicking the left mouse button on the load or tabbing to the list box and using the arrow up and down keys.
2. Make your changes to the moment by modifying the torque magnitude, and/or location.
3. Select MODIFY to replace the old data with the new data.

To delete point load data:

1. Select the point moment you want to delete from the point moment list box by clicking the left mouse button on the load or tabbing to the list box and using the arrow up and down keys.
2. Press the DELETE button.

Defining Support Loads and Displacements

You may enter prescribed support displacements and rotations as well as apply concentrated forces and moments to the system at support locations. These loads are input through the **Support Loads and Displacements** command of the **Input** menu.

To input support loads and displacements:

1. Select the **Support Loads and Displacements** command from the **Input** menu or click the  button on the tool bar. The dialog box of Figure 4-52 will appear.

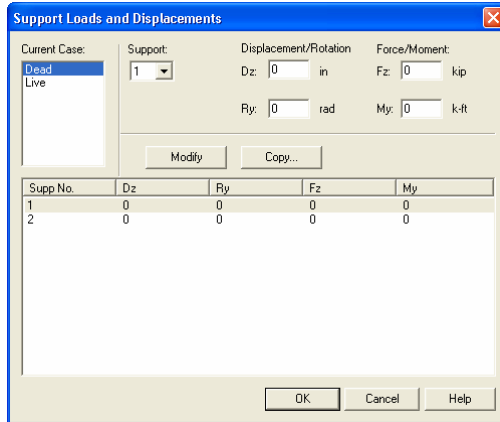

Figure 4-52 Defining Support Loads and Displacements

2. Select the load case of the support loads and displacements that will be defined from the CURRENT CASE list box.
3. From the SUPPORT drop-down list, select the support number of the support whose loads you would like to input.
4. Define un-factored values of the displacement, rotation, forces, and moment.
5. Select **Add** to add the support loads and displacements defined into the load list box on the lower part of the dialog box.
6. Repeat steps 2 through 5 until all the support loads and displacements have been entered then press OK button to exit the dialog box so that pcaSlab will use the new moments.

To change support and displacement loads data:

1. Select the entry you want to change from the load list box by clicking the left mouse button on the load or tabbing to the list box and using the arrow up and down keys.
2. Make your changes to the values.
3. Select **Modify** to replace the old data with the new data.

To delete support and displacement load data:

1. Select the entry you want to delete from the load list box by clicking the left mouse button on the load or tabbing to the list box and using the arrow up and down keys.
2. Press the DELETE button.

Defining Lateral Effects

pcaSlab can combine the gravity load analysis with a lateral load analysis. Lateral loads are entered as joint moments obtained elsewhere by a frame analysis. The joint moments are combined with the gravity load moments to produce load patterns 5 through 8.

To input lateral load moments:

1. Define at least one lateral load case from the **Load Cases** dialog box.
2. Select **Lateral Effects** from the **Input** menu. If no lateral case is defined this command is disabled. Once selected, Figure 4-53 will appear.

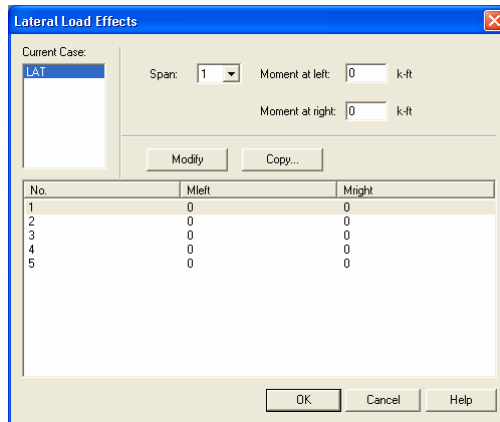

Figure 4-53 Lateral Moment dialog box

3. Select load cases from the CURRENT CASE list box. At least one lateral load case must be defined in the LOAD CASES dialog box before you can see the load case in the CURRENT CASE list box.
4. Select span number on which lateral loads will be defined from the SPAN drop-down list.
5. Enter the moments at the left end and right end of the span in the Moment at Left and Moment at Right input boxes, respectively.

6. Press the ADD button to add the lateral load defined above into the lateral load list box in the lower part of the dialog box.
7. Repeat steps 2 through 5 to define all the lateral loads.
8. To change an existing lateral load, select the load from the lateral load list box then change the moments as mentioned above. Press the MODIFY button when finished to update the data in the lateral load list box.
9. To delete an existing lateral load, select the load from the lateral load list box then press the DELETE button.
10. Select OK button when all the desired lateral loads have been modified to exit so that pcaSlab will use the new data.

Executing the Calculations (menu Solve)

Execute

The **Execute** command starts the design portion of pcaSlab after you have finished inputting all the data.

To design the system:

Select the **Execute** command from the **Solve** menu or click the  button on the tool bar. If any data required to analyze and design the system has not been input prior to executing this command, pcaSlab will display an "Invalid model!" message. You must complete the data before execution.

An analysis status window shows the current state of the execution as shown in. If the state of each of the computations is OK, the analysis is successful. If any error is encountered ERROR will be shown and the computation is terminated.

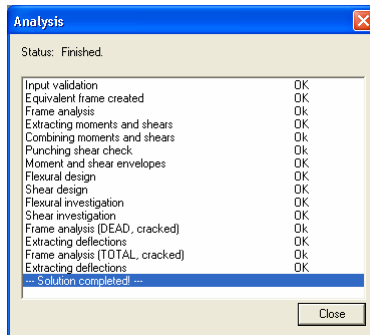



Figure 4-54 Analysis Status Window

Viewing Results Report

Once the analysis and/or design is performed, you can view the results, shear and moment diagrams, and deflected shapes. This section provides procedures performing these functions.

To view the analysis and design results:

1. Select **Report** command from the **Solve** menu or click the  button from the tool bar. A dialog box similar to Figure 4-55 will appear.

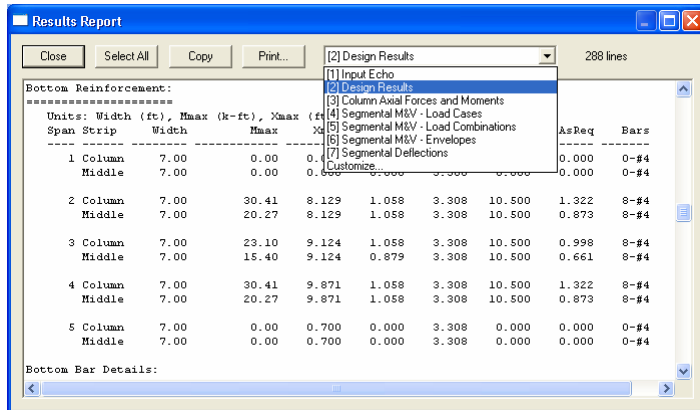

Figure 4-55 View and Print Results dialog box

2. Select the results you want to view from the drop-down list. The contents of the results box will be changed based on your selection. The Customize option allows for more than one result selection to be viewed in the results report.
3. Press the COPY button to copy the current results into the Windows clipboard. Then you may use CTRL + V to paste the contents of the clipboard to any other editors such as Word or Notepad.
4. Press the CLOSE button to close the result dialog box.

Saving Results Report

Analysis and design results are automatically saved to a text file named "projectname.out" in the same folder as the project data file (.slb file). The contents of the .out file depends on which option is selected from the drop-down list on the **Results Report** dialog box.

For example, if the project name is "Example 1 - FlatPlate (ACI Note)" and Input Echo is selected from the **Results Report** dialog box as shown in Figure 4-56, a text file named "Example 1 - FlatPlate (ACI Note).out" is generated automatically in the same directory as "Example 1 - FlatPlate (ACI Note).slb".

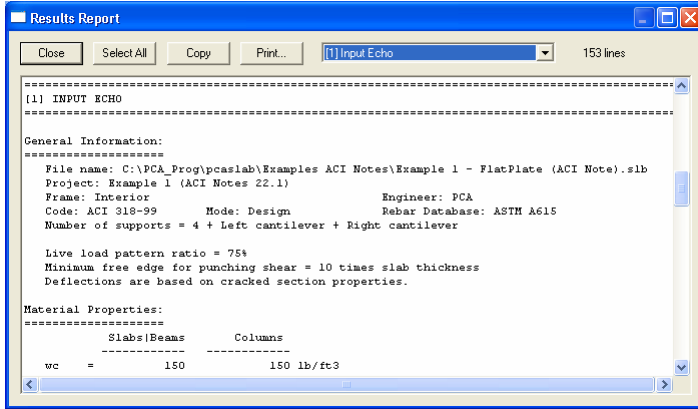

Figure 4-56 Input Echo is selected from Results Report dialog box

The file "Example 1 - FlatPlate (ACI Note).out" is a pure text file and can be opened, edited and printed using Word or Wordpad as shown in Figure 4-57.

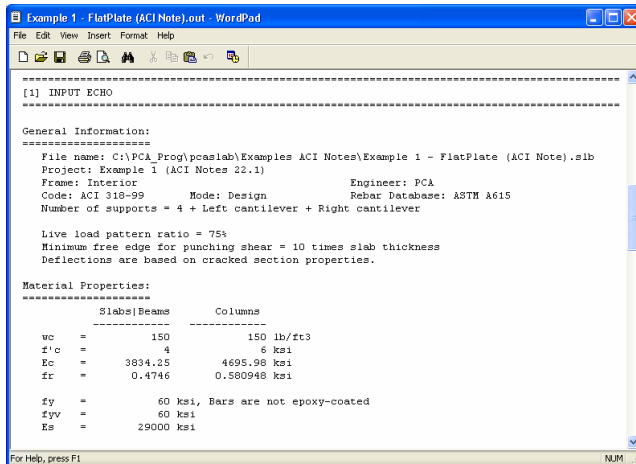

Figure 4-57 Output file is opened using Wordpad

Note: Once another option is selected from the **Results Report** dialog box, the contents of the .out file is changed based on the selection.

Output files (.out file) may not be in proper format if opened using Microsoft Notepad. Please use Word or Wordpad.

View Program Output (menu View)



Zooming in on the Floor System



In order to view the floor system in greater detail, pcaSlab allows you to magnify a portion of the floor system for closer analysis.

Using zoom with a magnifier:

1. Select **Zoom** from the **View** menu then a sub menu appears beside the **View** menu.
2. Select **Window** from the sub menu. Notice that the **Window** command is checked and the cursor is changed to a magnifier. The other way to magnify window is to click the  button on the tool bar.
3. Move the cross cursor to the upper left corner of the portion of the system you want to enlarge.
4. Press and hold down the left mouse button while dragging the cursor to the lower right portion of the system enclosing the desired area within the dashed box.
5. Release the mouse to enlarge that portion.

Using **Zoom In** and **Zoom Out** command:

1. Select **Zoom** from the **View** menu and a sub menu appears.
2. Select the **In(2x)** menu command from the sub menu. The current active window will be magnified by two times. The other way to do this is to click the  button on the tool bar.
3. Select the **Out(0.5x)** menu command from the sub menu. The current active window will be reduced by two times. The other way to do this is to click the  button on the tool bar.

Note: To return to original (default) zoom, select **Restore** from the **View** menu, or select  from tool bar. To move model in a view window, use **Pan** from the **View** menu, or select  from tool bar.

Change the Isometric View Angle

You can modify the X and Z angles at which the floor system is displayed in the isometric view window. By default, the floor system is viewed at -45° about the X axis and 45° about the Z axis. The right hand rule is used to determine the angle of rotation about the X and Z axes and the X axis is always rotated first.

To change angles:

1. Select **Change View Angle** from the **View** menu. The dialog box of Figure 4-58 appears displaying the currently set angles.

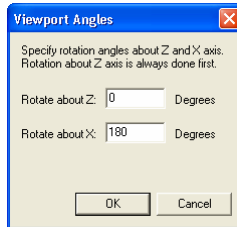

Figure 4-58 Isometric View dialog box

2. Change the angles of rotation about the X and Z axes. The X axis is rotated first then the Z axis is rotated. The floor system is rotated about the axis using the right hand rule.
3. Select OK button to accept the new angles and to modify the isometric view.

Note: A more convenient way to change the view angles instantly without entering angles in the dialog box is to use the keyboard shortcut CTRL + ARROW Keys. For example, press CTRL + ← and CTRL + → to rotate the floor system around Z axis and press CTRL + ↑ or CTRL + ↓ to rotate around X axis.

Viewing the Specific Member Type

In order to see the floor system members in greater detail, you can select specific member types to view by enabling and disabling them.

To select member type:

1. Select the **View Options** command from the **View** menu. The dialog box of Figure 4-59 will appear showing the currently displayed member types. Depending on the floor system, some of the member types will be shaded gray and unavailable.

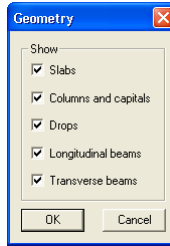



Figure 4-59 View Options dialog box

2. To hide a member type from a view of the floor system you must remove the ✓ sign from the check box. Click the left mouse button on the check box of the member type you would like to hide. To view a previously hidden member type, click the left mouse button on the check box to add the ✓ sign to the check box.
3. Select OK button to view only the selected member types.

Plan View

To switch to plan view:

1. Select the **Plan View** command from the **View** menu or click  button on the tool bar. The dialog box of Figure 4-60 will appear.

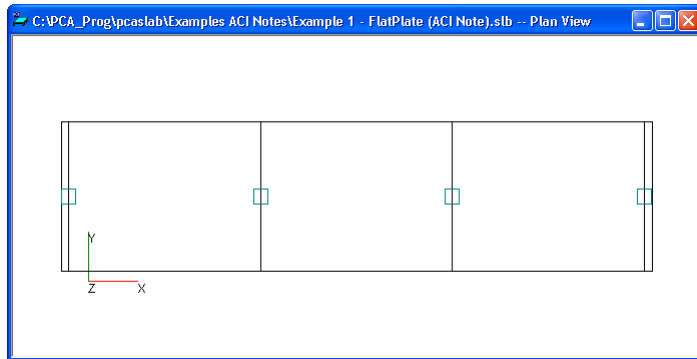

Figure 4-60 Plan View Window

2. Right click on the view window to show the pop-up menu. You may save the current view window as bitmap (BMP) file or metafile (EMF) on the Windows clipboard by selecting Copy Bitmap or Copy Metafile, respectively.

You may also select the commands from the pop-up menu to zoom in or zoom out the view window and preview it before printing it out.

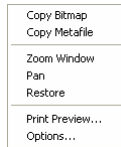

Figure 4-61 Pop-up Menu of View Window

3. Select the **Options** command from the pop-up menu, and then you may decide what geometry members need to be shown on the view window as shown in Figure 4-62. To hide a member type from a view of the floor system you must remove the ✓ sign from the check box. Click the left mouse button on the check box of the member type you would like to hide. To view a previously hidden member type, click the left mouse button on the check box to add the ✓ sign to the check box.

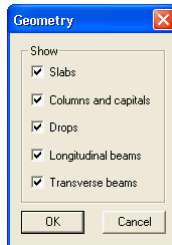



Figure 4-62 Geometry Options of Plan View

4. Select OK button to view only the selected member types.

Elevated View

To switch to elevated view:

1. Select the **Elevated View** command from the **View** menu or click  button from the tool bar. The dialog box of Figure 4-63 will appear.

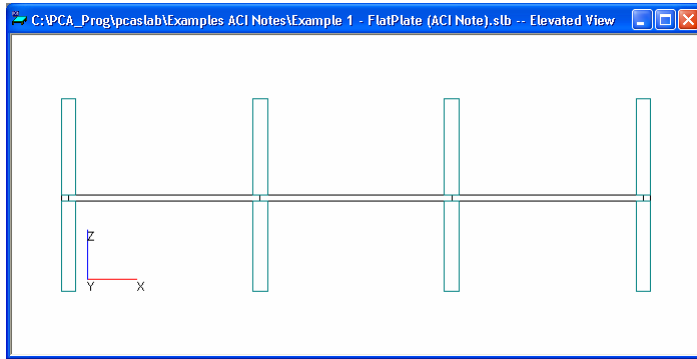

Figure 4-63 Elevated View Window

2. Right click on the view window to show the pop-up menu. You may save the current view window as bitmap (BMP) file or metafile (EMF) onto the Windows clipboard by selecting Copy Bitmap or Copy Metafile, respectively. You may also select the commands from the pop-up menu to zoom in or zoom out the view window and preview it before printing it out.

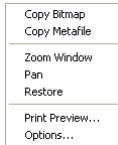

Figure 4-64. Pop-up Menu of View Window

3. Select the **Options** command from the pop-up menu, and then you may decide what geometry members need to be shown on the view window as shown in Figure 4-65. To hide a member type from a view of the floor system you must remove the ✓ sign from the check box. Click the left mouse button on the check box of the member type you would like to hide. To view a previously hidden member type, click the left mouse button on the check box to add the ✓ sign to the check box.

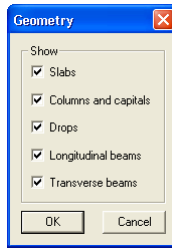



Figure 4-65 Geometry Options of Elevated View

4. Select OK button to view only the selected member types.

Side View

To switch to side view:

1. Select the **Elevated View** command from the **View** menu or click  button from the tool bar. The dialog box of Figure 4-66 will appear.

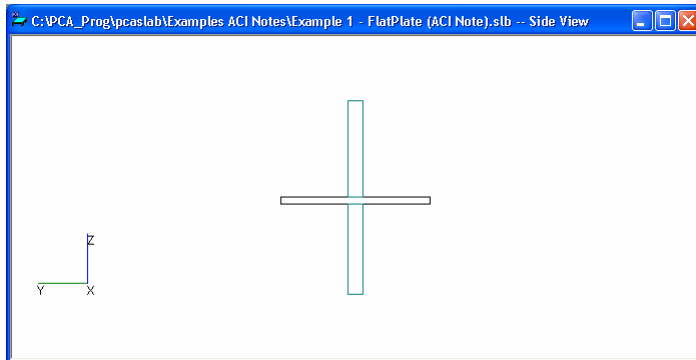

Figure 4-66 Side View Window

2. Right click on the view window to show the pop-up menu. You may save the current view window as bitmap (BMP) file or metafile (EMF) onto the Windows clipboard by selecting Copy Bitmap or Copy Metafile, respectively. You may also select the commands from the pop-up menu to zoom in or zoom out the view window and preview it before printing it out.

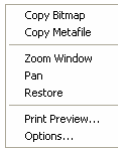

Figure 4-67 Pop-up Menu of View Window

3. Select the **Options** command from the pop-up menu, and then you may decide what geometry members need to be shown on the view window as shown in Figure 4-68. To hide a member type from a view of the floor system you must remove the ✓ sign from the check box. Click the left mouse button on the check box of the member type you would like to hide. To view a previously hidden member type, click the left mouse button on the check box to add the ✓ sign to the check box.

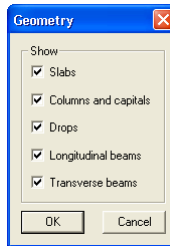



Figure 4-68 Geometry Options of Side View

4. Select OK button to view only the selected member types.

Isometric View

To switch to isometric view:

1. Select the **Isometric View** command from the **View** menu or click  button on the tool bar. The dialog box of Figure 4-69 will appear.

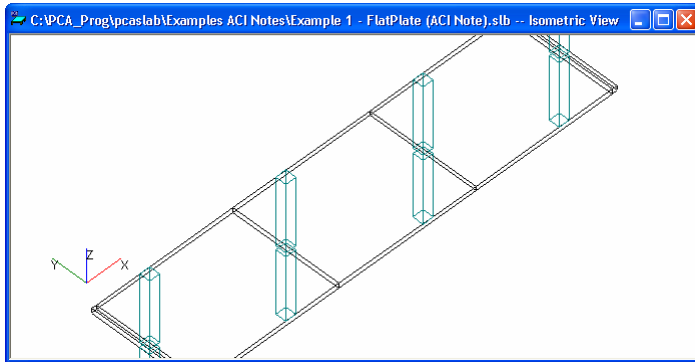

Figure 4-69 Isometric View Window

- Right click on the view window to show the pop-up menu. You may save the current view window as bitmap (BMP) file or metafile (EMF) onto the Windows clipboard by selecting Copy Bitmap or Copy Metafile, respectively. You may also select the commands from the pop-up menu to zoom in or zoom out the view window and preview it before printing it out.

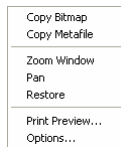

Figure 4-70 Pop-up Menu of View Window

- Select the **Options** command from the pop-up menu, and then you may decide what geometry members need to be shown on the view window as shown in Figure 4-71. To hide a member type from a view of the floor system you must remove the ✓ sign from the check box. Click the left mouse button on the check box of the member type you would like to hide. To view a previously hidden member type, click the left mouse button on the check box to add the ✓ sign to the check box.

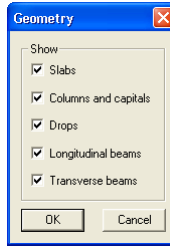



Figure 4-71 Geometry Options of Isometric View

4. Select OK button to view only the selected member types.

Loads

To show the loads:

1. Select the **Loads** command from the **View** menu or click  button from the tool bar. The dialog box of Figure 4-72 will appear.

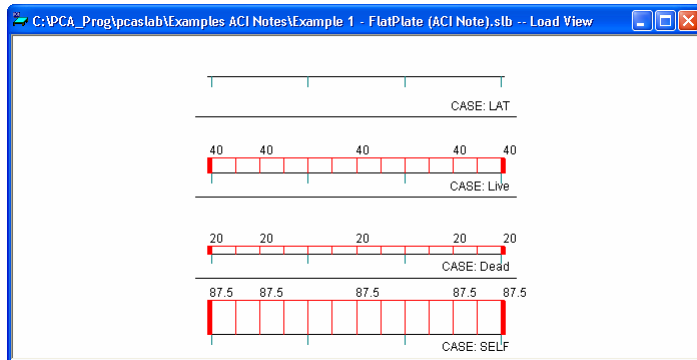

Figure 4-72 Loads View Window

2. Right click on the view window to show the pop-up menu. You may save the current view window as bitmap (BMP) file or metafile (EMF) onto the Windows clipboard by selecting Copy Bitmap or Copy Metafile, respectively. You may also select the commands from the pop-up menu to zoom in or zoom out the view window and preview it before printing it out.

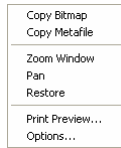

Figure 4-73 Pop-up menu of View Window

3. Select the **Options** command from the pop-up menu, and then you may decide what kind of loads need to be shown on the view window as shown in Figure 4-74. To hide a load case or type you must remove the ✓ sign from the check box. Click the left mouse button on the check box of the member type you would like to hide. To view a previously hidden load type, click the left mouse button on the check box to add the ✓ sign to the check box.

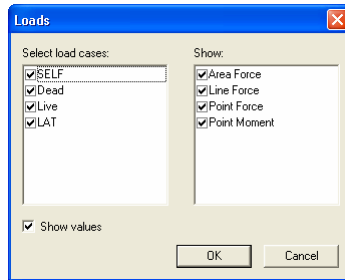

Figure 4-74 Loads Options

4. If you want to hide the load values, remove the ✓ sign before Show values check box.
5. Select OK button to view only the selected member types.

View Graphical Results

Viewing the Internal Forces Diagrams

Once the design has been performed, you may view the shear, moment, and internal torque (beams/one-way slab systems with torsion) diagrams for any span at any available load combination..

To view shears and moments diagram:

1. Select the **Internal Forces** command from the **View** menu or click the  button on the tool bar. A view window similar to Figure 4-75 will appear. The upper half view window shows the shear diagram and the lower half the view

window shows the moment diagram. If torsion is enabled for beams/one-way slab systems than internal torque diagram will also be shown in this window.

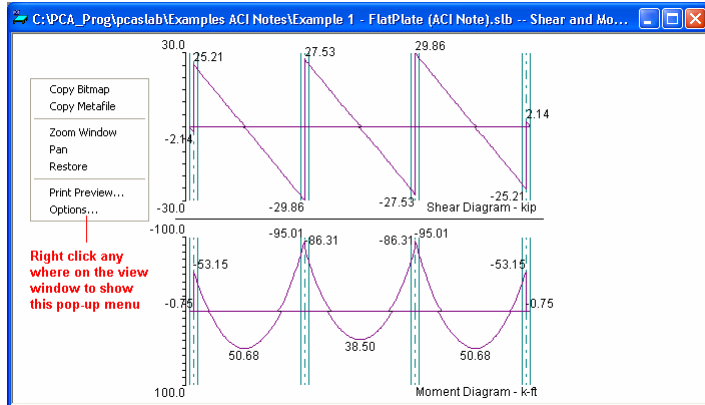

Figure 4-75 View Internal Forces Diagram

2. The current coordinate values can be captured based on the position of the mouse cursor. The status bar in Figure 4-76 shows the name of the diagram, two coordinate values of the current mouse cursor position, and the current design code used in the project.

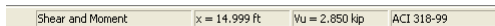

Figure 4-76. Coordinate Value Shown in Status Bar

3. Click the right mouse button anywhere on the view window to show the pop-up menu. You may **Restore**, **Zoom**, **Pan** or **Print View** directly by selecting commands from this pop-up menu.
4. Click the **Options** command from the pop-up menu to change the span for which the internal forces diagrams will be shown and to choose if legend will be displayed or not. Figure 4-77 shows the OPTIONS dialog box. Select a span number from the SHOW DIAGRAM FOR drop-down list and select a load Envelope or combination from the SELECT LOAD COMBINATIONS check list box. Use DRAW LEGEND checkbox to control whether legend is drawn or not. Press the OK button to close the dialog box and redraw the view windows.

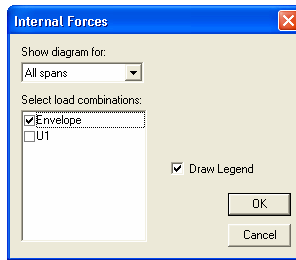



Figure 4-77 View Internal Forces Diagram Options

Note: The pop-up menu can be accessed from each of the view windows of pcaSlab.

The **Restore** command cannot be executed in the pop-up menu until the **Zoom** or **Pan** command is stopped by pressing the ESC key. Without stopping the **Zoom/Pan** command, one can only restore a view using the **Restore** command in **View** menu or  button in the tool bar. This occurs in all pcaSlab view windows.

Viewing the Moment Capacity

Once the design has been performed, you may view the moment capacity diagrams for any span at any available loading pattern. The moment capacity window will be split in half horizontally. The middle strip moment capacity will occupy the upper half and the column strip moment capacity will occupy the lower half where each diagram will be scaled to fill the entire half of the window.

To view moment capacity:

1. Select the **Moment Capacity** command from the **View** menu or click the  button on the tool bar. A view window similar to Figure 4-78 will appear.
2. Right click on the Moment Capacity view window and select **Options** command from the pop-up menu. A dialog box similar to Figure 4-79 will appear.
3. The current coordinate values can be captured based on the position of the mouse cursor. The status bar shows the name of the diagram, two coordinate values of the current mouse cursor position, and the current design code used in the project.
4. Click the right mouse button anywhere on the view window to show the pop-up menu. You may **Restore**, **Zoom**, **Pan** or **Print View** directly by selecting commands from this pop-up menu.

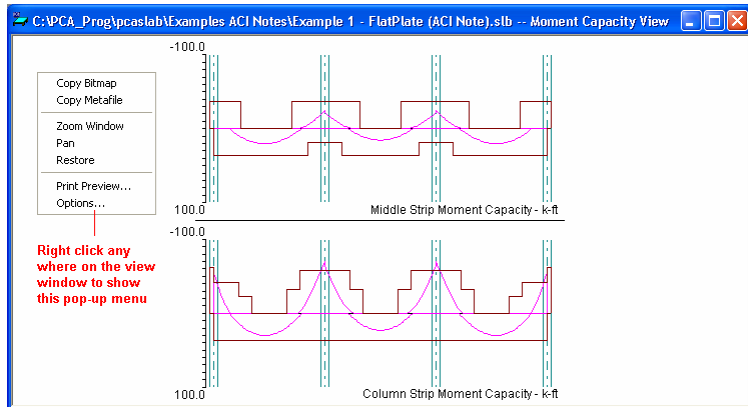

Figure 4-78 View Moment Capacity Diagram

5. Click the **Options** command from the pop-up menu to change the span for which the moment capacity will be shown. Select which span will be shown in the SHOW DIAGRAM FOR drop-down list. Use DRAW LEGEND checkbox to control whether legend is drawn or not. Select which part of the selected span will be shown in the Show frame box.
6. Press the OK button to close the dialog box and redraw the view windows.

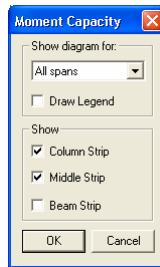



Figure 4-79 View Moment Capacity Option dialog box

Viewing the Shear Capacity

Once the design has been performed, you may view the slab shear capacity diagrams for any span at any available loading pattern.

To view shear capacity:

1. Select the **Shear Capacity** command from the View menu or click the  button on the tool bar. A view window similar to Figure 4-80 will appear.

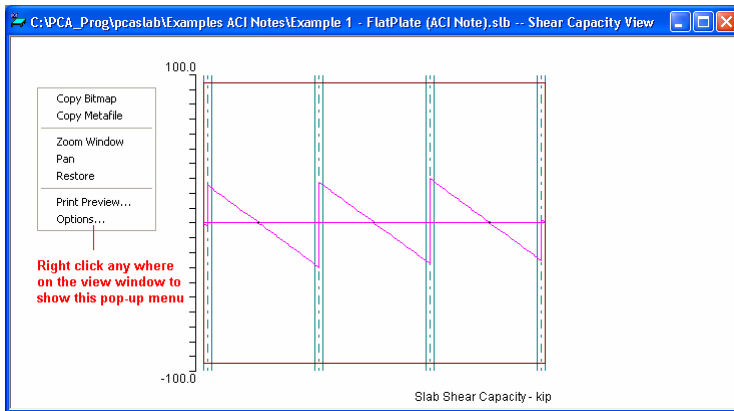

Figure 4-80 View Shear Capacity

- Right click on the Shear Capacity view window and select **Options** command from the pop-up menu. A dialog box similar to Figure 4-81 will appear.

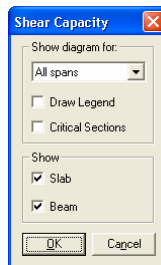

Figure 4-81 View Shear Capacity Option dialog box

- The current coordinate values can be captured based on the position of the mouse cursor. The status bar shows the name of the diagram, two coordinate values of the current mouse cursor position, and the current design code used in the project.
- Click the right mouse button anywhere on the view window to show the pop-up menu. You may **Restore**, **Zoom**, **Pan** or **Print View** directly by selecting commands from this pop-up menu.
- Click the **Options** command from the pop-up menu to change the span for which the shear capacity will be shown. Select which span will be shown in the SHOW DIAGRAM FOR drop-down list. Use DRAW LEGEND checkbox and CRITICAL SECTION checkbox to control if the legend and critical sections are

drawn or not. Select which part of the selected span will be shown in the SHOW frame box.

- Press the OK button to close the dialog box and redraw the view windows.

Viewing the Reinforcement

Once the design has been performed, you may view the reinforcement diagrams for any span at any available loading pattern. The reinforcement window will be split in half horizontally. The middle strip reinforcement will occupy the upper half, and the column strip reinforcement will occupy the lower half where each diagram will be scaled to fill the entire half of the window.

To view reinforcement:

- Select the **Reinforcement** command from the **View** menu or click the  button on the tool bar. A view window similar to Figure 4-82 will appear.

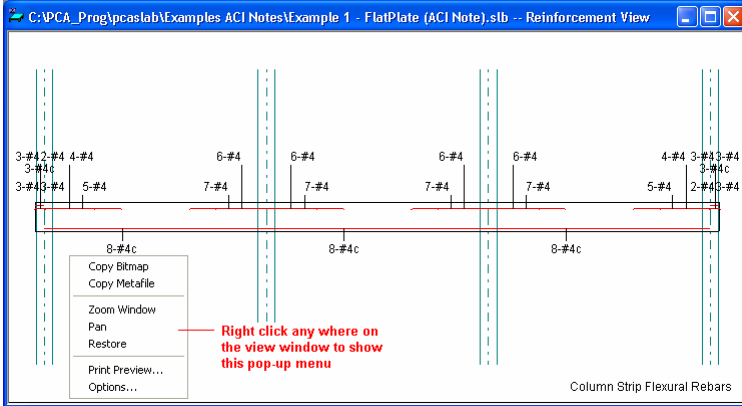

Figure 4-82 View Reinforcement

- Right click on the Reinforcements view window and select **Options** command from the pop-up menu. A dialog box similar to Figure 4-83 will appear.
- The current coordinate values can be captured based on the position of the mouse cursor. The status bar shows the name of the diagram, coordinate value of the current mouse cursor position in the design direction, and the current design code used in the project.
- Click the right mouse button anywhere on the view window to show the pop-up menu. You may **Restore**, **Zoom**, **Pan** or **Print View** directly by selecting commands from this pop-up menu.

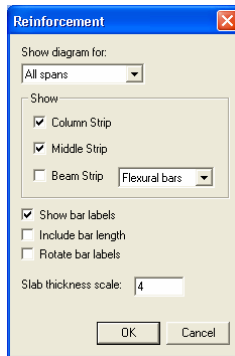

Figure 4-83 View Reinforcement Options dialog box

5. Click the **Options** command from the pop-up menu to change the span for which the shear capacity will be shown. Select the span you want to show from the **Show diagram for** drop-down list. Select which part of the selected span will be shown from the Show frame box. Checking the SHOW REBAR LABELS will show labels beside each rebar on the view. Similarly bar length can be included by checking INCLUDE BAR LENGTH. Bar labels can also be arranged vertically if ROTATE BAR LABELS is checked. Set the vertical scale (relative to the horizontal scale which is set automatically) to which members are drawn in the SLAB THICKNESS SCALE edit box.
6. Press the OK button to close the dialog box and redraw the view windows.

Viewing the Deflected Shapes

pcaSlab|pcaBeam

Once the design has been performed, you may view the deflection shapes for any span at any available loading pattern.

To view the deflection shapes:

1. Select the **Deflection** command from the **View** menu or click the  button on the tool bar. A view window similar to Figure 4-84 will appear.
2. Right click on the deflection view window and select **Options** command from the pop-up menu. A dialog box similar to Figure 4-85 will appear.
3. The current coordinate values can be captured based on the position of the mouse cursor. The status bar shows the name of the diagram, two coordinate values of the current mouse cursor position, and the current design code used in the project.

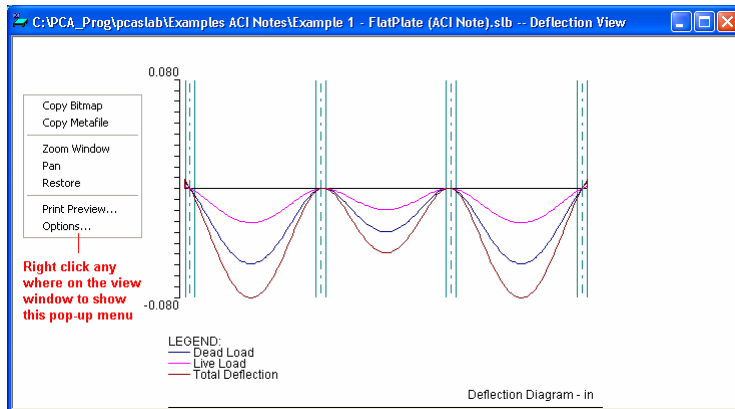

Figure 4-84 View Deflection Diagram

- Click the right mouse button anywhere on the view window to show the pop-up menu. You may **Restore**, **Zoom**, **Pan** or **Print View** directly by selecting commands from this pop-up menu.

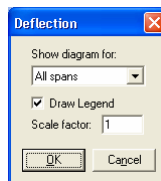

Figure 4-85 View Deflection Option dialog box

- Click the **Options** command from the pop-up menu to change the span for which the deflection will be shown. Select the span you want to show from the SHOW DIAGRAM FOR drop-down list. Check the Draw Legend checkbox to include the legend in the drawing. Enter the scale factor in the SCALE FACTOR edit box. The bigger the scale factor, the more apparent the deflections will be on the diagram.
- Press the OK button to close the dialog box and redraw the view windows.

Print Results

Printing the Analysis and Design Results

Once the analysis and/or design is performed, you can print the results. This section provides procedures for performing these functions.

To print the analysis and design results:

1. Select **Report** command from the **Solve** menu or click the  button from the tool bar. A dialog box similar to Figure 4-86 will appear.

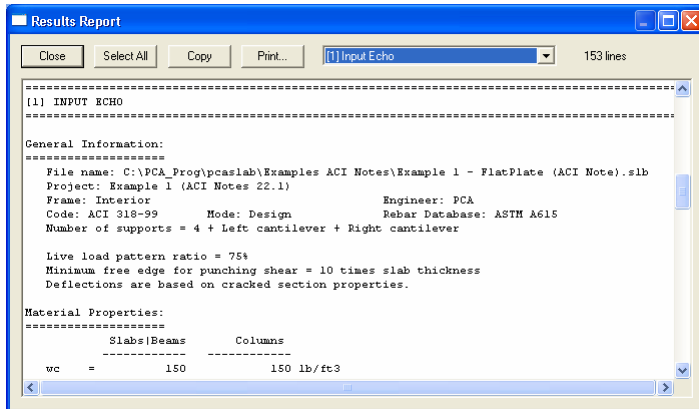

Figure 4-86 View and Print Results dialog box

2. Select the results you want to view from the drop-down list. The contents of the results list box will be changed based on your selection.
3. Press the PRINT button on the dialog box to print the results through a printer. The printer could be a local printer which is connected to your computer directly, or a network printer.
4. Press the CLOSE button to close the result dialog box.

Printing the Current View Window

Once the design has been performed, you may print the diagrams and views for any span at any available loading pattern by selecting the **Print View** command from the **File** menu.

To print a displaying window:

1. To select the diagram or view you want to print, single click the left mouse button on the diagram or view window.
2. Select the **Print View** command from the **File** menu. A print preview window similar to Figure 4-87 will be shown.

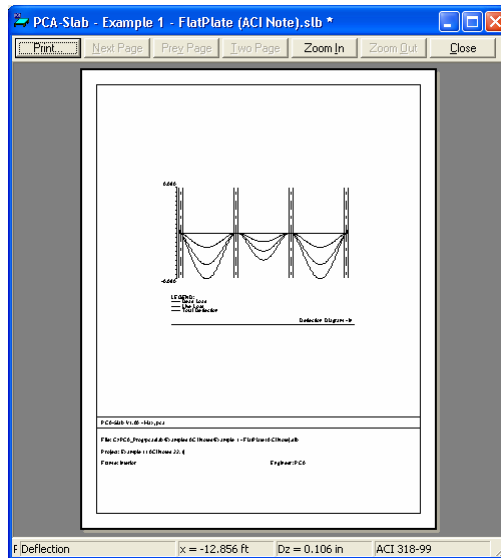

Figure 4-87 Print Preview of a View Window

3. Press the ZOOM IN or ZOOM OUT buttons or simply click the left mouse button on the preview to magnify or reduce the size of the preview paper.
4. Press the NEXT PAGE button if more than one page need to be printed.
5. Press the PRINT button to print the view. The printer could be a local printer which is connected to your computer directly, or a network printer.
6. Press the CLOSE button to close the preview window and go back to pcaSlab.

Print Preview

The **Print Preview** command allows you to preview and print the current view window (floor system geometry in the plan, elevated and isometric views, prints the shear and moment diagrams, and the deflected shapes).

1. To obtain a view window you must first perform the design, then select what you want to view from the **View** menu. You may have more than one view window opened. The current view window is the one activated and on top of the others on your screen.
2. Selecting this command closes the pcaSlab main window and opens the print preview window as shown in Figure 4-87.

3. On the print preview window, press the ZOOM IN or ZOOM OUT buttons or simply click the left mouse button on the preview window to magnify or reduce the size of the preview paper.
4. Press the NEXT PAGE button if more than one page needs to be printed.
5. Press the PRINT button to print the view. The printer could be a local printer which is connected to your computer directly, or a network printer.
6. Press the CLOSE button to close the preview window and go back to pcaSlab.

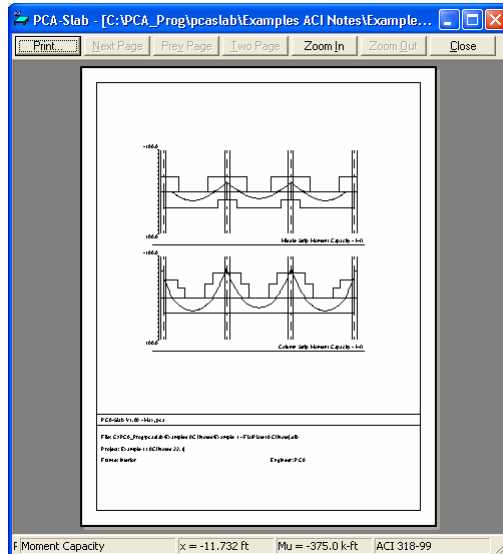

Figure 4-88 Print Preview Window

Copy Graphs to Clipboard

Copy Bitmap (BMP format)

pcaSlab can copy any of the ten view windows onto Windows clipboard as bitmap. The bitmap on clipboard can then be pasted into Microsoft Word or other Windows applications including presentation software such as Microsoft PowerPoint.

To copy view window to clipboard as bitmap:

1. Select the view window that will be copied by single clicking left mouse button on it.

2. Select  from the tool bar to copy the selected view window to clipboard.
3. Switch to other word processing software, such as Microsoft Word, then press the CTRL + V to paste the bitmap on clipboard to a Word file.

Copy Metafile (EMF format)

Since bitmap files cannot easily be resized or re-proportioned without significant distortion to the image, metafiles are generally used for situations requiring scalability of the image.

Advantages of metafiles are:

- Large, simply structured images require less memory than bitmaps for display and make optimal use of the resolution of the output device.
- Metafiles can be resized with none of the distortion which normally accompanies resizing of bitmaps.
- A metafile can contain SelectPalette statements, allowing custom palettes to be displayed in applications such as Microsoft Word.

The Enhanced MetaFile (EMF) format is an extension of the Windows metafiles format developed for use with 32 bit Windows applications. It is only available to native 32 bit applications.

To copy view window to clipboard as Enhanced MetaFile (EMF):

1. Select the view window that will be copied by single clicking left mouse button on it.
2. Select  from the tool bar to copy the selected view window to clipboard.
3. Switch to other word processing software, such as Microsoft Word, then press the CTRL + V to paste the bitmap on clipboard to a Word file.

Customizing Program (menu Options)

Changing Colors

Colors can be changed for background of views, geometry items such as slabs and beams, text on views, result diagrams, etc.

To change colors:

1. Select **Colors** command from the **Options** menu. Figure 4-89 will appear.

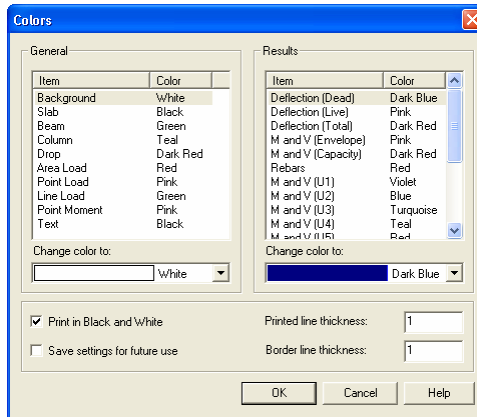

Figure 4-89 Changing Colors dialog box

- From the **General** frame box on the left side, select the item whose color needs to be changed from the list box.
- Select a color from the **Change color to** drop-down list. Once a new color is selected from the drop-down list the color in the list box above the drop-down list is updated instantly.
- From the Results category box on the right side, select the item whose color needs to be changed from the list box.
- Select a color from the **Change color to** drop-down list. Once a new color is selected from the drop-down list the color in the list box above the drop-down list is updated instantly.
- If you want to print views in black and white, select the **Print Black and White** check box.
- If you want to save the settings as default, select the **Save** setting for future use check box.
- Input the line thickness in the Printed Line Thickness edit box. The diagram line thickness will be based on the number you input.
- Press the OK button to save the settings and close the dialog box.

Changing Fonts

Fonts can be selected separately for both the graphical output and the text output via **Options|Font** command.

To change the graphical output font:

1. Select the **FontGraphical Output** command from the **Options** menu. A view window similar to Figure 4-90 will appear.

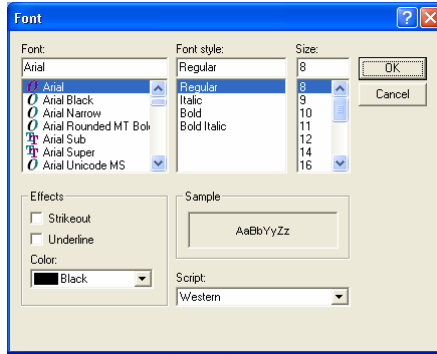

Figure 4-90 Changing Graphical Output Font dialog box

2. Select the font, font style and size from the lists. Font sizes different from those on the list can be typed in.
3. In the EFFECT frame select if strikeout and/or underline effect have to be applied. Alternatively to the COLOR dialog box, the font color can be chosen in this dialog box too.
4. The script of the font by default is Western and should not be changed.
5. Press the OK button to save the new setting and close the dialog box.

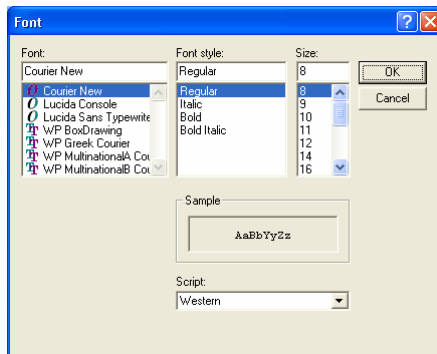

Figure 4-91 Changing Text Output Font dialog box

To change the text output font follow the same procedure as for the graphical output font except that font effects are not available for text output and the list of

fonts only contains non-proportional fonts which are suitable for tabulated text output (Figure 4-91).

Changing Startup Defaults

To change the startup defaults:

1. Select the **Startup Defaults** command from the **Options** menu. A view window similar to Figure 4-92 will appear.

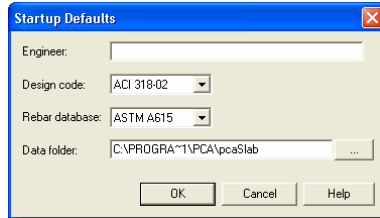

Figure 4-92 Changing Startup Defaults dialog box

2. Input the name of the engineer in the Engineer edit box. The name of the engineer will be shown on the view print.
3. Select the design code from the **Design code** drop-down list. Four design codes are available: ACI 318-99, ACI 318M-99, CSA A23.3-94 and CSA A23.3-94E.
4. Select the rebar database from the **Rebar database** drop-down list. Four defined databases are available: ASTM A615, ASTM A615M, CSA G30.18 and prEN 10080. If you would like to use rebar defined by yourself, select the **User Defined** from the drop-down list. You may define your own rebar database by selecting the **Rebar Database** from the **Options** menu.
5. Press the OK button to save the new setting and close the dialog box.

Changing the Rebar Database

User can define his own rebar database. The defined database, such as ASTM A615M, cannot be changed.

To change the rebar database:

1. Select the **Rebar Database** from the **Options** menu. Figure 4-93 will appear.
2. Select **User-defined** from the **Current Bar Set** drop-down list. Rebar data of the other databases can only be viewed and cannot be changed.

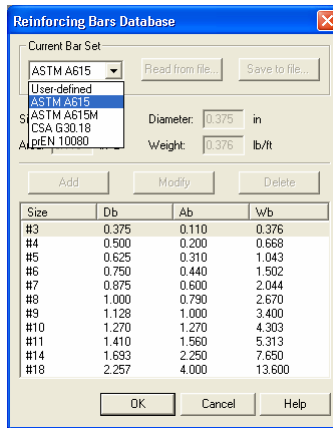

Figure 4-93 Changing Rebar Database

3. To select the rebar that needs to be changed from the rebar list box, single click the left mouse button on it. The size, diameter, area, and weight of the selected rebar are shown in the corresponding text boxes, respectively.
4. Enter the new values of bar size, diameter, area, and weight.
5. Press the ADD button to add the bar as a new bar into the rebar list box on the lower part of the dialog box. If any data inconsistency is found by pcaSlab, an error of "Inconsistent bar data" will be shown.
6. Press the MODIFY button to update an existing rebar.
7. To delete a rebar, select the rebar from the rebar list box then click the DELETE button.
8. After finishing the definitions of your own rebar database, you may save them into a file on the hard drive by pressing the SAVE TO FILE button and specifying a file name for your database. This file can be imported into pcaSlab by pressing the READ FROM FILE button.

Working with View Windows (menu Window)

Cascade

The **Cascade** command displays all the open windows in the same size, arranging them on top of each other so that the title bar of each is visible. The current active view widow will be on the top after the execution of the **Cascade** command.

Tile Horizontal



The **Tile Horizontal** command arranges all open windows horizontally so that no window overlaps another. The current active view widow will be on the most left or on the upper-left corner of the screen after the execution of the **Tile Horizontal** command.

Tile Vertical



The **Tile Vertical** command arranges all open windows vertically so that no window overlaps another. The current active view widow will be on the most left or on the upper-left corner of the screen after the execution of the **Tile Vertical** command.

Remaining Commands



The remaining menu items are in a list of the windows that are available for viewing. Selecting any window from this menu will restore the window to its previous size and position from an icon.

Obtaining Help Information (menu Help)



Opening Table of Contents of the Help System



To open table of contents of the Help system:

1. Select **Help Topics** from the **Help** menu.
2. Select the chapter you need from the content tree view in the left pane of the Help window. The contents of the selected chapter appear in the right pane of the Help window.

Displaying Help Topic Associated with Selected Element



To display the topic associated with the selected element:

1. Select **Context Help** from the **Help** menu. The mouse cursor changes to .
2. Click the element for which you need information about. The program will display the topic which is associated with the element you clicked.

Obtaining Information about the Program



The following information about the program is displayed in the ABOUT PCASLAB dialog box:

- program version and short description

- licensing information
- the copyright information

The licensing information depends on the type of license being used. If it is a trial license then the LICENSE EXP field shows when the trial period expires and the LOCKING CODE field displays a unique fingerprint of the computer on which the program is running. This locking code (also displayed in the license activator window, see *License Activation*) needs to be provided to pcaStructurePoint in order to generate a permanent license. For other, non-trial licenses, license ID is displayed. You may be asked to provide this ID when you contact pcaStructurePoint for technical support.

To open the obtain the information about the program:

1. Select the **About pcaSlab** command from the **Help** menu. A dialog box of Figure 4-94 will appear.

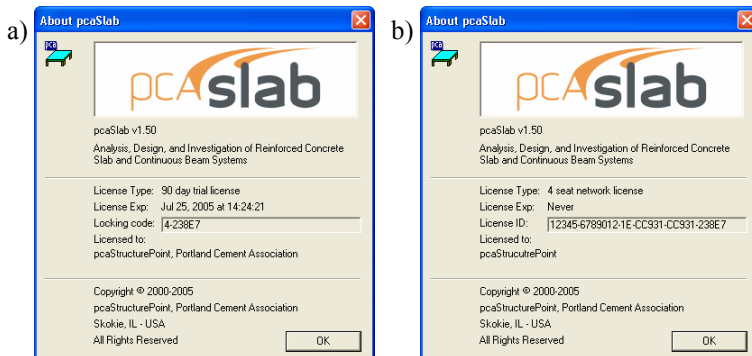

Figure 4-94 About pcaSlab dialog boxes with (a) a trial license (b) a network license

2. Press OK button to exit the dialog box.

Chapter 5

Output Description

Output Elements



pcaSlab generates the text and graphical output of the input data and the results of the calculations. The text output is generated when user opens the Results Report dialog window. An ASCII text file is generated in the same sub-folder as the input data file. The name of the output file is created by adding the extension ".OUT" to the name of the input data file. Depending on the report options selected, the text output will contain a selection of the following sections (see the illustrated examples in the following chapter):

- Program Information
- [1] Input Echo
- [2] Design Results
- [3] Column Axial Forces And Moments
- [4] Internal Forces – Load Cases
- [5] Internal Forces – Load Combinations
- [6] Internal Forces – Envelopes
- [7] Deflections

Program Version



The program version number appears at the top of each report page along with the licensing and copyright information. Additionally, legal disclaimer is displayed on the first page of the text output.

Input Echo



Section Input Echo reports the data used in the analysis. pcaSlab defaults common data; all other data must be input. Carefully check the contents of the section and

compare it with the intended design model. The following paragraphs describe the blocks included in the section.

General Information



This block is similar in its content to the dialog window General Information. It contains the information on project input data file name, project description, selected design code and units, selected rebar database, calculation mode (design or investigation), number of supports, cantilevers. The selections available in the SOLVE OPTIONS dialog box are also listed in this block.

Material Properties



This block contains the information on concrete properties for slabs, beams and columns. It also contains the information on reinforcing steel properties for slabs and beams.

Rebar Database



This block lists the properties of the bars from the bar table selected for the project. Bar diameter, cross-section area and unit weight for each bar are reported. The values reported are consistent with the units used in particular model.

Span Data



This block is similar in its content to the dialog window Span Data. The block is divided into two parts. First part reports the span-by-span geometry of the concrete slab (length, left and right side width, depth and code required minimum thickness). The second part contains the span-by-span geometry of longitudinal beams and ribs (for waffle slabs).

Support Data



This block is similar in its content to the dialog window Support Data. The block is divided into four parts. The first part reports the geometry of top and bottom columns and the stiffness share factor. For circular column the transverse dimension C2 is reported as zero. The second part contains the geometry of drop panels: thickness, lengths, widths. If dimensions of a drop panel are invalid it will be marked. Invalid or excessive drop panel geometry is not used in the analysis. The third part contains the geometry of column capitals: depth, slope (depth/extension ratio), extensions. The fourth part contains the geometry of transverse beams: width depth, eccentricity (offset) from column centroid.

Load Data

This block contains the complete information on load input. The block is divided into three parts. The first part reports the defined load cases, load combinations and corresponding load factors. This part summarizes the contents of the dialog windows Load Cases and Load Combinations. The second part reports the magnitudes of defined span loads. It summarizes the contents of the dialog window Span Loads. The third part reports the magnitudes of lateral actions (joint moments) if defined in the model. It summarizes the contents of the dialog window Lateral Load Effects.

Reinforcement Criteria

This block is similar in its content to the dialog window Reinforcement Criteria. The block is divided into three parts. The first part reports the requirements for slab and rib bars. The second part reports the requirements for longitudinal beams. Both parts contain the information on bar sizes, covers, spacings and user selected allowable steel percentages. The requirements for top and bottom bars are given. For longitudinal beams additionally the criteria for transverse bars (stirrups) are listed.

Reinforcing Bars

This block is available only when Investigation Mode is selected. This block is similar in its content to the dialog window Reinforcing Bars. The block is divided into three parts. The first part reports the span-by span user selected top bars for column, middle and beam strips accordingly. Similarly, the second part reports the user selected bottom bars for column, middle and beam. For longitudinal bars the program reports bar sizes, lengths and concrete cover. The third part presents the beam transverse reinforcement (stirrups) defined by the user.

Note: When switching from Design Mode to Investigation Mode, pcaSlab automatically assumes the results of the Design Mode as an input for Investigation Mode.

Design Results

Section Design Results presents the summary of the design results of the slab system. The following paragraphs describe the blocks included in the section.

Top Reinforcement

This block is available only when Design Mode is selected. It reports the negative reinforcement requirements. The block contains the values of corresponding

design strip widths (column, middle, and beam), maximum factored design moments per strip and critical location, minimum and maximum steel areas, bar spacings, steel areas required by ultimate condition, selected bar sizes and numbers. The quantities are given for left, center and right location of each span. For a detailed discussion, see Chapter 2, "Area of Reinforcement".

Note: This block does not include reinforcement quantities necessary to transfer negative unbalanced moment at supports.

Top Bar Details



The block contains a span-by-span listing of the longitudinal bars selected in column, middle and beam strips. This reinforcement schedule is intended as a guide for bar placement. In more complex cases the bar schedule selected by the program may have to be adjusted by the user for constructability reasons. The selected bar sizes are limited by user specified minimum and maximum sizes. Bar sizes and numbers are selected to satisfy the minimum and required steel areas in conjunction with the bar spacing requirements of the Code. The program calculates the bar lengths based on the computed inflection points and the recommended minimums of the Code. The bar lengths are adjusted by appropriate development lengths. Hooks and bends are not included in bar length tables and figures. For beams bars are placed in single a layer (see Figure 2-21), provided there is sufficient beam width. For a detailed discussion, see Chapter 4, "Reinforcement Selection".

Note: This block does not include additional reinforcement bars necessary to transfer negative unbalanced moment at supports.

Band Reinforcement at Supports



This section is available only when the CSA code is selected. It describes how the negative reinforcement in column strips should be concentrated over supports. This section reports the width of the column strip and the widths of the band strip and the remaining strip that the column strip is subdivided into. It also gives the area of reinforcement as well as the number of bars required in each strip. The sum of number of bars in the band strip and in the remaining strip should be equal to the total number of bars in the column strip over each support. The number of bars in the column strip should be consistent with the number of bars listed in the Top Bar Details table.

Note: This block does not include additional reinforcement bars necessary to transfer negative unbalanced moment at supports.

Bottom Reinforcement



This block is available only when Design Mode is selected. It reports the positive reinforcement requirements. The block contains the values of corresponding design strip widths (column, middle, and beam), maximum factored design moments per strip and critical location, minimum and maximum steel areas, bar spacings, steel areas required by ultimate condition, selected bar sizes and numbers. The quantities are given for mid-span regions of each span. For a detailed discussion, see Chapter 2, "Area of Reinforcement".

Bottom Bar Details



This block contains a span-by-span listing of the longitudinal bars selected in column, middle and beam strips. The reinforcement schedule is intended as a guide for bar placement. In more complex cases the bar schedule selected by the program may have to be adjusted by the user for constructability reasons. The selected bar sizes are limited by user specified minimum and maximum sizes. Bar sizes and numbers are selected to satisfy the minimum and required steel areas in conjunction with the bar spacing requirements of the Code. The program calculates the bar lengths based on the computed inflection points and the recommended minimums of the Code. The bar lengths are adjusted by appropriate development lengths. Hooks and bends are not included in bar length tables and figures. For beams bars are placed in single a layer (see Figure 2-21), provided there is sufficient beam width. For a detailed discussion, see Chapter 2, "Reinforcement Selection".

Flexural Capacity



This block lists the selected top and bottom steel areas and corresponding negative and positive moment capacity values in each span. The data is subdivided between column, middle and beam strips. Each span is subdivided into segments reflecting the changes in geometry and bar placement.

Longitudinal Beam Shear Reinforcement Required



This block is available only when Design Mode is selected. It reports the requirements of transverse reinforcement for each longitudinal beam. The capacity of concrete cross-section ϕV_c in each span is shown. The table contains the segmental values of the factored shear force V_u and required intensity of stirrups (A_v/s). The segmental values cover the distance between left and right critical sections, and include locations where there is change of geometry of loading.

Longitudinal Beam Shear Reinforcement Details

pcAslab|pcABeam

This block is available only when Design Mode is selected. It is intended as a guide for stirrup placement. The output presents the program selected stirrup sizes, numbers and spacings. Distances between groups of stirrups are also reported.

Beam Shear (and Torsion) Capacity

pcAslab|pcABeam

If torsion is not considered then this block lists the concrete section shear capacity ϕV_c , selected stirrup intensities and spacings and corresponding beam shear capacity ϕV_n values in each span. The maximum factored shear forces V_{max} in beam strip along the span also reported.

In the case of combined shear and torsion analysis (beams/one-way slab systems only), this block lists section properties, shear and torsion transverse reinforcement capacity, and longitudinal torsional reinforcement capacity. The provided and required capacities are expressed in terms of the provided and required areas of reinforcement.

Slab Shear Capacity

pcAslab

This block lists the values of one-way slab shear capacity ϕV_c in each span. The maximum factored shear force V_u and the location of the critical section X_u are also reported.

Flexural Transfer of Negative Unbalanced Moment at Supports

pcAslab

This block reports the design values for additional negative reinforcement necessary to transfer unbalanced support moments. The block contains the results for critical (effective) section width as per the Code, the maximum unbalanced moment, the corresponding load combination and governing load pattern, the reinforcing steel areas provided and additional steel required. The provided reinforcement area (main longitudinal bars) is reduced by the ratio of critical (effective) strip width to total strip width and does not include the required area due to unbalanced moments. The additional reinforcement is the difference between that required by unbalanced moment transfer by flexure and that provided for design bending moment. When additional reinforcement is required, it is selected based on the bar sizes already provided at the support. For a detailed discussion, see Chapter 2, "Area of Reinforcement" and "Additional Reinforcement at Support".

Punching Shear Around Columns



The block contains the values pertaining to punching shear check in critical sections around the columns. The table lists two sets of punching shear calculations – direct shear alone and direct shear with moment transfer. The output contains the values of the allowable shear stress ϕv_c , reactions V_u , unbalanced moments M_{unb} , governing load pattern, fraction of unbalanced moment ϕv , punching shear stress v_u . The calculation for moment transfer adjusts the unbalanced moment to the centroid of the critical section. The "shear transfer" is the unbalanced moment multiplied by γ_v . When calculated shear stress v_u exceeds the allowable value ϕv_c , the program prints a warning flags for this support. For a detailed discussion, see Chapter 2, "Shear Analysis of Slabs".

Punching Shear Around Drops



The block contains the values pertaining to punching shear check in a critical section around the drop panels. The table displays the reactions V_u , governing load pattern, the punching shear stress around the drop v_u , and the allowable shear stress ϕv_c . When calculated shear stress v_u exceeds the allowable value ϕv_c , the program prints a warning flags for this drop panel. For a detailed discussion, see Chapter 2, "Shear Analysis of Slabs".

Integrity Reinforcement at Supports



This section is available only when the CSA code is selected. It lists the shear transferred to the column and the minimum area of bottom reinforcement crossing one face of the periphery of a column and connecting slab to the column to provide structural integrity. For a detailed discussion, see Chapter 2, "Integrity Reinforcement".

Corner Reinforcement



This block refers to the reinforcement required in the exterior corners of a slab with beams between columns. The ratio of flexural stiffness of beam section to flexural stiffness of slab is listed as well as the area of reinforcement and the distance over which the reinforcement is required. The area applies to each layer of reinforcement in each direction. For a detailed discussion, see Chapter 2, "Slab Corners".

Shear Resistance at Corner Columns



This section is available only when the CSA code is selected. It reports results of one-way shear check at corner columns. The results include the factored shear

resistance and the factored shear force at the column. Also, the minimum length of the critical shear section and the angle at which the minimum length is obtained are listed. For a detailed discussion, see Chapter 2, "Shear Resistance at Corner Columns" in "Shear Analysis of Slabs".

Maximum Deflections

pcAslab|pcABeam

This block lists the summary of dead load (DL), live load (LL) and total (DL+LL) short-time deflections for the entire equivalent frame, column and middle strips. If solution option "Gross (uncracked) sections" is selected, the values of deflections reported are based on gross section properties. If solution option "Effective (cracked) sections" is used, the values of deflections reported are based on substitute effective moment of inertia of the section. For a detailed discussion, see Chapter 2, "Deflection Calculation".

Material Takeoff

pcAslab|pcABeam

This block lists the approximate total and unit quantities of concrete, and reinforcement. Note that the reinforcement estimate is for one direction only and ignores items such as hooks, bends, and waste. For a detailed discussion, see Chapter 2, "Material Quantities".

Column Axial Forces and Moments

pcAslab|pcABeam

Section Column Axial Forces and Moments presents the summary of unfactored axial forces (reactions) and bending moments in bottom and top columns in the column-slab joints. If moment redistribution is selected (beams/one-way slab systems only) both redistributed and un-redistributed values can be included. The values reported represent the loading of a single floor only. Any actions on the columns from the floors above must be added to this story's actions to properly analyze/design the columns. The output contains column actions due to Selfweight, Dead Load, Live Load, and Total Combination. The Live Load values for all four load patterns are presented. The values for Live Load pattern No.4 are not combined because this load pattern is not singular (each support has individual load configuration).

Internal Forces - Load Cases

pcAslab|pcABeam

This section presents the summary of unfactored bending moments and shear forces for individual load cases including selfweight, dead load, live load and lateral cases. The reported values are presented using span-by-span segmental

approach. If moment redistribution is selected (beams/one-way slab systems only) both redistributed and un-redistributed values can be included.

Internal Forces - Load Combinations

This section presents the summary of bending moments and shear forces for each load combination. The reported values for each load combination are presented using span-by-span segmental approach. The negative and positive values of bending moments and shear forces are presented in separate columns in order to provide consistent format with enveloped output. If moment redistribution is selected (beams/one-way slab systems only) both redistributed and un-redistributed values can be included.

Internal Forces - Envelopes

This section presents the summary of bending moments and shear forces for envelope of all load combinations. The reported values are presented using span-by-span segmental approach. The negative and positive values of bending moments and shear forces are presented in separate columns for user convenience. The factored values presented in this section are used for design purposes (longitudinal and transverse reinforcement). If moment redistribution is selected (beams/one-way slab systems only) both redistributed and un-redistributed values can be included.

Deflections

This section presents the summary of deflections for unfactored (service) load cases including selfweight and dead load (DL), live load (LL) and combined (DL+LL) load cases. The reported values are presented using span-by-span segmental approach. If solution option "Gross (uncracked) sections" is selected, the values of deflections reported are based on gross section properties. If solution option "Effective (cracked) sections" is used, the values of deflections reported are based on substitute effective moment of inertia of the section. For a detailed discussion, see Chapter 2, "Deflection Calculation".

Graphical Output

pcaSlab provides the following graphical output features:

- Diagrams of Internal Forces,

- Moment Capacity Diagram,
- Shear (and Torsion) Capacity Diagram,
- Deflection Diagram,
- Reinforcement Diagram.

These diagram windows can be customized. The **Options** dialog allows selecting either a single span or all spans. Other elements of the graphs can also be modified. pcaSlab print preview of the current graphical window. The user has also the choice to export the graphics to a metafile or bitmap file.

Detailed information on using the graphical output features is included in chapter "Operating the Program".

Chapter 6

Examples

In this chapter several examples are presented to demonstrate capabilities of the program. These examples refer to problems solved in *PCA Notes on ACI 318-02* and other established text books. Generally program results match closely the results found in the references. When discrepancies are observed, they result from variations in assumptions and solutions methods, and numerical accuracy.

Both beams/one-way slab systems as well as two-way slab systems are presented in the examples. The output of beams/one-way slab examples shows that *pcaBeam* program was used to solve them. This is to illustrate that *pcaBeam* program is available as a limited version of *pcaSlab* including only beams/one-way slab capabilities.

Example 1 Spandrel beam with moment redistribution



Problem description

Determine the required reinforcement for the spandrel beam at an intermediate floor level as shown, using moment redistribution to reduce total reinforcement required. (Note: the self weight is already included in the specified dead load below.) This example refers to Example 8-2 from *PCA Notes on ACI 318-02 Building Code Requirements for Structural Concrete*, Portland Cement Association, 2002.

Columns:		16 × 16 in.
Story height:		10 ft
Spandrel beam:		12 × 16 in.
f'_c	=	4000 psi
f_y	=	60,000 psi
DL	=	1167 lb/ft
LL	=	450 lb/ft

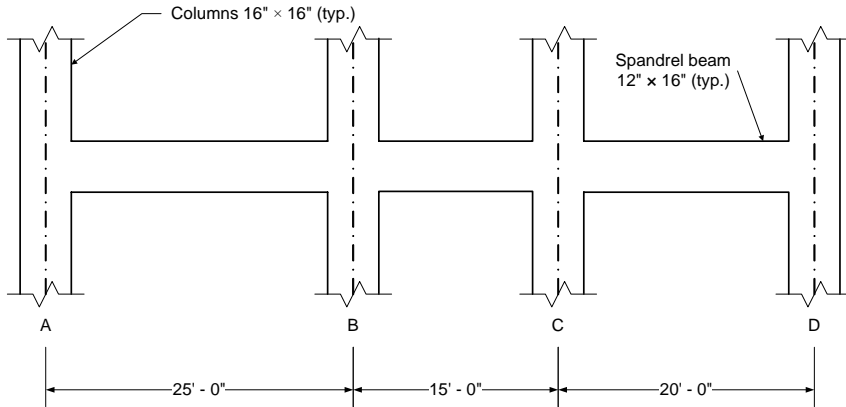
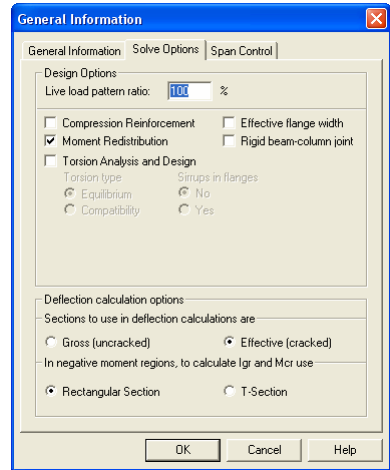
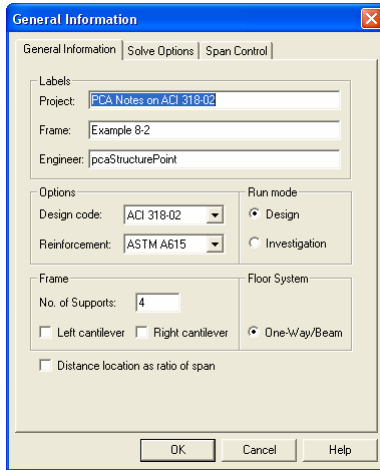

Figure 6-1 Example spandrel beam problem

Prepering the input

1. From the **Input** menu, select **General Information**. A dialog box appears.
 - In the LABELS section, input the names of the project, frame, and engineer.
 - In the FRAME section, input 4 for NO OF SUPPORTS.
 - In the FLOOR SYSTEM section, click the radial button next to ONE WAY / BEAM.
 - Leave all other options in the **General Information** tab to their default settings of ACI 318-02 design code, ASTM A615 reinforcement, and DESIGN run mode option.
 - In the **Solve Options** tab, click the check box next to MOMENT REDISTRIBUTION. Press OK.



2. Nothing needs to be changed in the **Material Properties** menu.

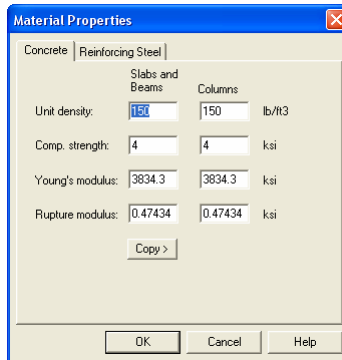

3. From the **Input** menu, select **Spans**. A dialog box appears.

- Under the **Slabs/Flanges** tab, input 25 for LENGTH, 0 for THICKNESS, and 0 for WIDTH LEFT and WIDTH RIGHT. Press MODIFY.
- Press the drop down arrow next to SPAN and select Span 2. Input 15 for LENGTH, 0 for THICKNESS, and 0 for WIDTH LEFT and WIDTH RIGHT. Press MODIFY.

- Press the drop down arrow next to SPAN and select Span 3. Input 20 for LENGTH, 0 for THICKNESS, and 0 for WIDTH LEFT and WIDTH RIGHT. Press MODIFY.
- Select the **Longitudinal Beams** tab. Input 12 for WIDTH and 16 for DEPTH. Press MODIFY.
- Press COPY. Press the CHECK ALL button. Press OK.
- Press OK again.

The screenshot shows a 'Span Data' dialog box with the following fields and values:

- Span: 1 (dropdown)
- Location: Interior (dropdown)
- Length: 25 ft
- Thickness: 0 in
- Width Left: 0 ft
- Width Right: 0 ft

Buttons: Modify, Copy...

Span No.	Location	Length	Thickness	Width-L	Width-R
1	Interior	25	0	0	0
2	Interior	15	0	0	0
3	Interior	20	0	0	0

Buttons: OK, Cancel, Help

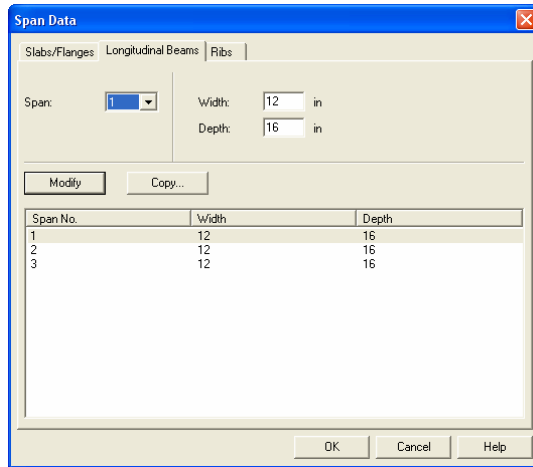

4. From the **Input** menu, select **Supports**. A dialog box appears.
 - Under the **Columns** tab, input 16 for both the C1 and C2 values in both the ABOVE and BELOW rows. Press MODIFY. (Note: the default HEIGHT ABOVE and HEIGHT BELOW values of 10 are correct.)
 - Press COPY. Press the CHECK ALL button. Press OK.
 - Under the **Moment Redistribution** tab, click on SUPPORT 2 in the list in the bottom half of the SUPPORT DATA dialog box.
 - Input 20 for both the LEFT and RIGHT REDISTRIBUTION LIMITS. Press MODIFY.
 - Press COPY. Click the check box next to SPAN 3. Press OK.
 - Press OK again.

Support Data

Columns | Column Capitals | Transverse Beams | **Moment Redistribution** | Boundary Conditions

Support: 1

Stiffness share %: 100

Height (ft) Above: 10 Below: 10

c1 (in) 16 16

c2 (in) 16 16

Modify Copy...

Sup. No	Stiff%	HtA	c1A	c2A	HtB	c1B	c2B
1	100	10	16	16	10	16	16
2	100	10	16	16	10	16	16
3	100	10	16	16	10	16	16
4	100	10	16	16	10	16	16

OK Cancel Help

Support Data

Columns | Column Capitals | Transverse Beams | **Moment Redistribution** | Boundary Conditions

Support: 1

Redistribution Limits [%]

Left: 0

Right: 0

Modify Copy...

Sup. No	Left	Right
1	0	0
2	20	20
3	20	20
4	0	0

OK Cancel Help

- Nothing needs to be changed in the **Reinforcement** menu.

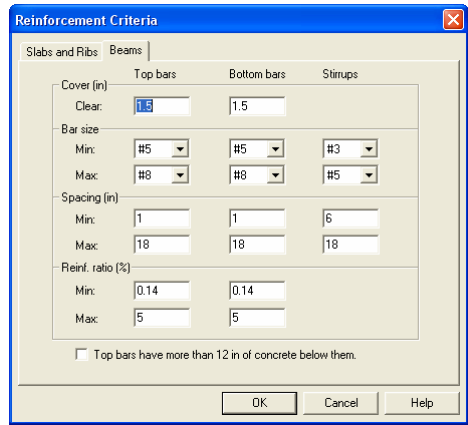
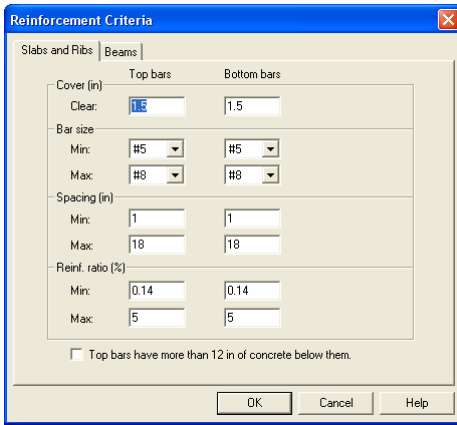

6. From the **Input** menu, select **Load Cases**. A dialog box appears.
 - Since we are not considering lateral forces, click on WIND in the LABEL column on the list in the bottom half of the LOAD CASES dialog box and press the DELETE button.
 - Click on EQ in the LABEL column and press the DELETE button. Press OK.

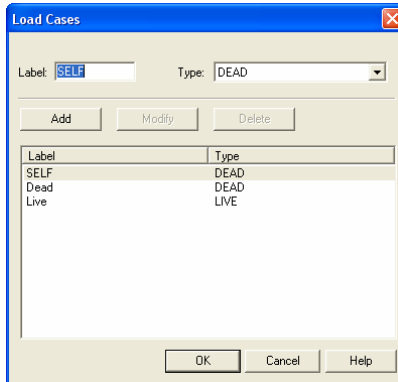

7. From the **Input** menu, select **Load Combinations**. A dialog box appears.
 - Delete all the load combinations by clicking anywhere on the list in the bottom half of the LOAD COMBINATIONS dialog box and pressing the DELETE button. Repeat this procedure until all the load combinations are gone.

- Input 0 in the SELF field, 1.2 in the DEAD field, and 1.6 in the LIVE field. Press ADD.
- Press OK.

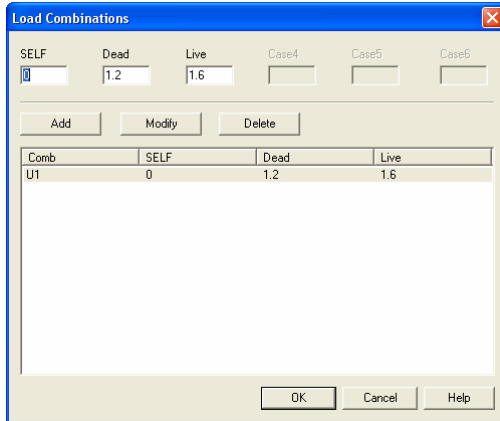

8. From the **Input** menu, select **Span Loads**. A dialog box appears.
 - Press the drop down arrow next to TYPE, and select LINE LOAD.
 - Input 1167 for both the START and END MAGNITUDE.
 - Input 25 for the END LOCATION. Press ADD.
 - Use the drop down arrow next to SPAN to select SPAN 2. Keep the START and END MAGNITUDES of 1167 lb/ft but change the END LOCATION to 15. Click the ADD button.
 - Again use the drop down arrow next to SPAN to select SPAN 3. Keep the START and END MAGNITUDES of 1167 lb/ft but change the END LOCATION to 20. Click the ADD button

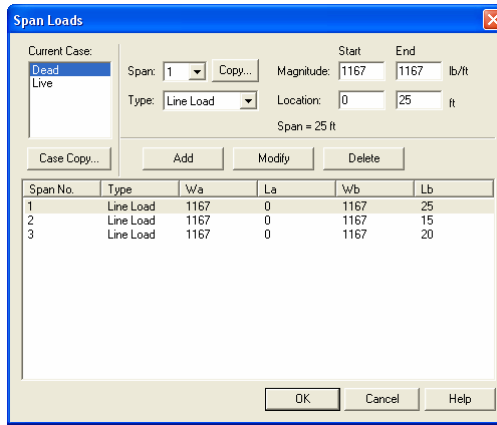

9. In the top left corner of the SPAN LOADS dialog box, there is a section called CURRENT CASE. Click on LIVE.
 - Use the drop down arrow next to SPAN to select SPAN 1.
 - Making sure that LINE LOAD is still the selected LOAD TYPE, input 450 for both the START and END MAGNITUDE.
 - Input 25 for the END LOCATION. Press ADD.
 - Use the drop down arrow next to SPAN to select SPAN 2. Keep the START and END MAGNITUDES of 450 lb/ft but change the END LOCATION to 15. Click the ADD button.
 - Again use the drop down arrow next to SPAN to select SPAN 3. Keep the START and END MAGNITUDES of 1167 lb/ft but change the END LOCATION to 20. Click the ADD button
 - Press OK.

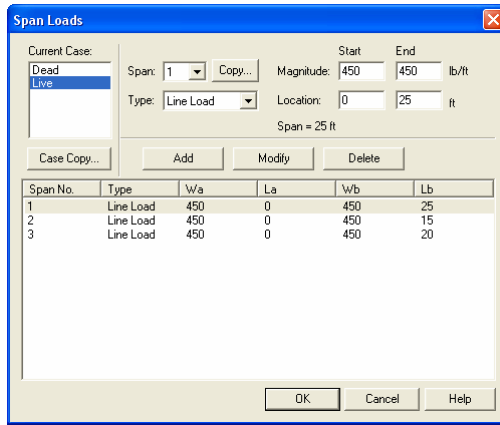

10. From the **Solve** menu, select **Execute**. Press **CLOSE**.
11. From the **Solve** menu, select **Results Report**.
 - Use the scroll bars to scroll through the results file.
 - Use the **ARROW** keys or the mouse wheel to browse through different parts of the results quickly. Press the **CLOSE** button to close the **RESULTS REPORT** dialog box and return to **pcabeam**.
12. To view diagrams, select **Loads**, **Internal Forces**, **Moment Capacity**, **Shear Capacity**, **Deflection**, or **Reinforcement** from the **View** menu. Right click in any of these diagrams to get new copy, printing, or display options.
13. You may print the results file by selecting **Print Results** from the **File** menu. To print any of the diagrams you selected to view, use the **Print Preview** command found by right clicking in the diagram's window. After viewing the results, you may decide to investigate the input beams under the same loads but with a modified reinforcement configuration.
14. From the **Input** menu, select **General Information**. In the **General Information** dialog box change the **RUN MODE** option to **INVESTIGATION**. Do not change any of the other options. Press **OK**
15. From the **Input** menu, select the different commands under **Reinforcement Criteria** and **Reinforcing Bars** to modify the reinforcement configuration computed by the program.
16. Repeat steps 10 and subsequent to perform the investigation and view the results.

Text Output (abbreviated)

```

oooooooo      oooooo      ooooo
oooooooooooo  oooooooooo  ooooooooo
oo  oo      oo  oo      oo  oo
oo  oo      oo  oo      oo  oo
oooooooooooo  oo          oooooooooo  ooooo
oooooooooooo  oo  oo      oooooooooo  ooooo
oo           oo  oo      oo  oo
oo           oooooooooo  oo  oo
oo           ooooooo      oo  oo

```

```

ooooo  ooooooo  oooooo  oo  oo
oo  oo  oo      oo  oo  ooo  ooo
oo  oo  oo      oo  oo  oo  o  o  oo
oo  oo  oo      oo  oo  oo  o  o  oo
oooooooo  oooooo  oooooooooo  oo  o  oo
oo  oo  oo      oo  oo  oo      oo
oo  oo  oo      oo  oo  oo      oo
oo  oo  oo      oo  oo  oo      oo
ooooo  ooooooo  oo  oo  oo      oo

```

```

=====
                          pcaBeam v1.50 (TM)
A Computer Program for Analysis, Design, and Investigation of
Reinforced Concrete Continuous Beam and One-Way Slab Systems
=====
                          Copyright © 1992-2005, Portland Cement Association
                          All rights reserved

```

Licensee stated above acknowledges that Portland Cement Association (PCA) is not and cannot be responsible for either the accuracy or adequacy of the material supplied as input for processing by the pcaBeam computer program. Furthermore, PCA neither makes any warranty expressed nor implied with respect to the correctness of the output prepared by the pcaBeam program. Although PCA has endeavored to produce pcaBeam error free the program is not and cannot be certified infallible. The final and only responsibility for analysis, design and engineering documents is the licensees. Accordingly, PCA disclaims all responsibility in contract, negligence or other tort for any analysis, design or engineering documents prepared in connection with the use of the pcaBeam program.

```

=====
[1] INPUT ECHO
=====

```

General Information:
=====

```

File name: C:\Data\pcaBeam\PCA Notes on ACI 318-02 Example 8-2.slb
Project: PCA Notes on ACI 318-02
Frame: Example 8-2
Code: ACI 318-02      Mode: Design
Number of supports = 4
Floor System: One-Way/Beam

```

```

Engineer: pcaStructurePoint
Reinforcement Database: ASTM A615

```

```

Live load pattern ratio = 100%
Deflections are based on cracked section properties.
In negative moment regions, Igr and Mcr DO NOT include flange/slab contribution (if available)
Compression reinforcement calculations NOT selected.
Moment redistribution selected.
Effective flange width calculations NOT selected.
Rigid beam-column joint NOT selected.
Torsion analysis and design NOT selected.

```

Material Properties:

```

=====
          Slabs|Beams          Columns
          -----
wc =          150          150 lb/ft3
f'c =          4          4 ksi
Ec =          3834.3          3834.3 ksi
fr =          0.47434          0.47434 ksi

fy =          60 ksi, Bars are not epoxy-coated
fyv =          60 ksi
Es =          29000 ksi
  
```

Reinforcement Database:

```

=====
Units: Db (in), Ab (in^2), Wb (lb/ft)
Size  Db      Ab      Wb      Size  Db      Ab      Wb
-----
#3    0.38    0.11    0.38    #4    0.50    0.20    0.67
#5    0.63    0.31    1.04    #6    0.75    0.44    1.50
#7    0.88    0.60    2.04    #8    1.00    0.79    2.67
#9    1.13    1.00    3.40    #10   1.27    1.27    4.30
#11   1.41    1.56    5.31    #14   1.69    2.25    7.65
#18   2.26    4.00    13.60
  
```

Span Data:

```

=====
Slabs: Ll, wL, wR (ft); t, Hmin (in)
Span Loc      Ll      t      wL      wR      Hmin
-----
1 Int    25.000  0.00  0.500  0.500  0.00
2 Int    15.000  0.00  0.500  0.500  0.00
3 Int    20.000  0.00  0.500  0.500  0.00
  
```

Ribs and Longitudinal Beams: b, h, Sp (in)

```

Span  Ribs      Beams      Span
      b      h      Sp      b      h      Hmin
-----
1     0.00  0.00  0.00    12.00  16.00  16.22 *b
2     0.00  0.00  0.00    12.00  16.00   8.57
3     0.00  0.00  0.00    12.00  16.00  12.97
  
```

NOTES:

*b- Span depth is less than minimum.

Support Data:

```

=====
Columns: c1a, c2a, c1b, c2b (in); Ha, Hb (ft)
Supp  c1a  c2a  c1b  c2b  Ha  c1b  c2b  Hb  Red%
-----
1     16.00  16.00  10.000  16.00  16.00  16.00  10.000  100
2     16.00  16.00  10.000  16.00  16.00  16.00  10.000  100
3     16.00  16.00  10.000  16.00  16.00  16.00  10.000  100
4     16.00  16.00  10.000  16.00  16.00  16.00  10.000  100
  
```

Moment Redistribution Limits

```

Supp  Left[%]  Right[%]
-----
1     0        0
2     20       20
3     20       20
4     0        0
  
```

Boundary Conditions: Kz (kip/in); Kry (kip-in/rad)

```

Supp  Spring Kz  Spring Kry  Far End A  Far End B
-----
1     0        0  Fixed  Fixed
2     0        0  Fixed  Fixed
3     0        0  Fixed  Fixed
  
```

4 0 0 Fixed Fixed

Load Data:

=====

Load Cases and Combinations:

Case	SELF	Dead	Live
Type	DEAD	DEAD	LIVE
U1	0.000	1.200	1.600

Span Loads:

Span Case	Wa	La	Wb	Lb

Line Loads - Wa Wb (lb/ft), La Lb (ft):				
1 Dead	1167	0	1167	25
2 Dead	1167	0	1167	15
3 Dead	1167	0	1167	20
1 Live	450	0	450	25
2 Live	450	0	450	15
3 Live	450	0	450	20

Support Loads: --- NONE ---

Support Displacements: --- NONE ---

Reinforcement Criteria:

=====

	Top bars		Bottom bars		Stirrups	
	Min	Max	Min	Max	Min	Max

Slabs and Ribs:						
Bar Size	#5	#8	#5	#8		
Bar spacing	1.00	18.00	1.00	18.00	in	
Reinf ratio	0.14	5.00	0.14	5.00	%	
Cover	1.50		1.50		in	
Beams:						
Bar Size	#5	#8	#5	#8	#3	#5
Bar spacing	1.00	18.00	1.00	18.00	6.00	18.00
Reinf ratio	0.14	5.00	0.14	5.00	%	
Cover	1.50		1.50		in	

[2] DESIGN RESULTS

Moment Redistribution Factors:

=====

Units: Org.Mu (k-ft)

Supp	Side	Org.Mu	Calculated			User Limit[%]	Applied Factor[%]
			Iter.#	EpsilonT	Factor[%]		
1	Right	83.53	7	0.01796	17.96	0.00	0.00
2	Left	91.92	6	0.01526	15.26	20.00	15.26
2	Right	41.57	2	0.04168	20.00	20.00	20.00
3	Left	32.97	2	0.05368	20.00	20.00	20.00
3	Right	57.21	2	0.02909	20.00	20.00	20.00
4	Left	49.30	2	0.03446	20.00	0.00	0.00

Top Reinforcement:

=====

Units: Width (ft), Mmax (k-ft), Xmax (ft), As (in^2), Sp (in)

Span Zone	Width	Mmax	Xmax	AsMin	AsMax	SpReq	AsReq	Bars
1 Left	1.00	83.10	0.667	0.568	3.075	1.993	1.404	5-#5
Middle	1.00	0.00	12.500	0.000	3.075	0.000	0.000	---
Right	1.00	75.67	24.333	0.568	3.075	1.993	1.269	5-#5

2 Left	1.00	31.23	0.667	0.568	3.075	1.993	0.502	5-#5
Middle	1.00	0.00	7.500	0.000	3.075	0.000	0.000	---
Right	1.00	24.35	14.333	0.518	3.075	3.986	0.389	3-#5
3 Left	1.00	43.45	0.667	0.568	3.075	3.986	0.706	3-#5
Middle	1.00	0.00	10.000	0.000	3.075	0.000	0.000	---
Right	1.00	48.84	19.333	0.568	3.075	3.986	0.798	3-#5

Top Bar Details:

=====

Units: Length (ft)

Span	Left				Continuous		Right			
	Bars	Length	Bars	Length	Bars	Length	Bars	Length	Bars	Length
1	3-#5	8.48	2-#5	5.40	---		3-#5	8.48	2-#5	5.40
2	3-#5	5.18	2-#5	3.40	---		2-#5	5.18	1-#5	3.40
3	2-#5	6.83	1-#5	4.40	---		2-#5	6.83	1-#5	4.40

Bottom Reinforcement:

=====

Units: Width (ft), Mmax (k-ft), Xmax (ft), As (in^2), Sp (in)

Span	Width	Mmax	Xmax	AsMin	AsMax	SpReq	AsReq	Bars
1	1.00	69.82	12.625	0.568	3.075	2.657	1.164	4-#5
2	1.00	25.96	7.624	0.553	3.075	7.972	0.416	2-#5
3	1.00	47.12	9.876	0.568	3.075	3.986	0.769	3-#5

Bottom Bar Details:

=====

Units: Start (ft), Length (ft)

Span	Long Bars			Short Bars		
	Bars	Start	Length	Bars	Start	Length
1	2-#5	0.00	25.00	2-#5	5.91	13.53
2	2-#5	0.00	15.00	---		
3	2-#5	0.00	20.00	1-#5	5.76	8.13

Flexural Capacity:

=====

Units: From, To (ft), As (in^2), PhiMn (k-ft)

Span	From	To	AsTop	AsBot	PhiMn-	PhiMn+
1	0.000	0.667	1.55	0.62	-91.01	38.31
	0.667	3.717	1.55	0.62	-91.01	38.31
	3.717	5.401	0.93	0.62	-56.51	38.31
	5.401	5.905	0.93	0.62	-56.51	38.31
	5.905	6.793	0.93	0.62	-56.51	38.31
	6.793	7.214	0.00	0.62	0.00	38.31
	7.214	8.477	0.00	1.24	0.00	74.08
	8.477	8.950	0.00	1.24	0.00	74.08
	8.950	12.500	0.00	1.24	0.00	74.08
	12.500	16.050	0.00	1.24	0.00	74.08
	16.050	16.523	0.00	1.24	0.00	74.08
	16.523	18.045	0.00	1.24	0.00	74.08
	18.045	18.128	0.93	1.24	-56.51	74.08
	18.128	19.437	0.93	0.62	-56.51	38.31
	19.437	19.599	0.93	0.62	-56.51	38.31
19.599	21.121	0.93	0.62	-56.51	38.31	
21.121	24.333	1.55	0.62	-91.01	38.31	
24.333	25.000	1.55	0.62	-91.01	38.31	
2	0.000	0.667	1.55	0.62	-91.01	38.31

	0.667	2.401	1.55	0.62	-91.01	38.31
	2.401	3.401	0.93	0.62	-56.51	38.31
	3.401	4.177	0.93	0.62	-56.51	38.31
	4.177	5.177	0.00	0.62	0.00	38.31
	5.177	5.450	0.00	0.62	0.00	38.31
	5.450	7.500	0.00	0.62	0.00	38.31
	7.500	9.550	0.00	0.62	0.00	38.31
	9.550	9.823	0.00	0.62	0.00	38.31
	9.823	10.823	0.00	0.62	0.00	38.31
	10.823	11.599	0.62	0.62	-38.31	38.31
	11.599	12.599	0.62	0.62	-38.31	38.31
	12.599	14.333	0.93	0.62	-56.51	38.31
	14.333	15.000	0.93	0.62	-56.51	38.31
3	0.000	0.667	0.93	0.62	-56.51	38.31
	0.667	3.401	0.93	0.62	-56.51	38.31
	3.401	4.401	0.62	0.62	-38.31	38.31
	4.401	5.755	0.62	0.62	-38.31	38.31
	5.755	5.827	0.62	0.62	-38.31	38.31
	5.827	6.755	0.00	0.62	0.00	38.31
	6.755	6.827	0.00	0.93	0.00	56.51
	6.827	7.200	0.00	0.93	0.00	56.51
	7.200	10.000	0.00	0.93	0.00	56.51
	10.000	12.800	0.00	0.93	0.00	56.51
	12.800	12.883	0.00	0.93	0.00	56.51
	12.883	13.173	0.00	0.62	0.00	38.31
	13.173	13.883	0.00	0.62	0.00	38.31
	13.883	14.190	0.00	0.62	0.00	38.31
	14.190	15.599	0.62	0.62	-38.31	38.31
	15.599	16.617	0.62	0.62	-38.31	38.31
	16.617	19.333	0.93	0.62	-56.51	38.31
	19.333	20.000	0.93	0.62	-56.51	38.31

Longitudinal Beam Shear Reinforcement Required:

Units: d (in), Start, End, Xu (ft), PhiVc, Vu (kip), Av/s (in^2/in)								
Span	d	PhiVc	Start	End	Vu	Xu	Av/s	
1	14.00	15.94	1.833	4.881	22.99	1.833	0.0112	
			4.881	7.929	16.53	4.881	0.0100	
			7.929	10.976	10.07	7.929	0.0100	
			10.976	14.024	3.61	10.976	0.0000	
			14.024	17.071	9.41	17.071	0.0100	
			17.071	20.119	15.87	20.119	0.0100	
			20.119	23.167	22.34	23.167	0.0102	
2	14.00	15.94	1.833	3.452	12.91	1.833	0.0100	
			3.452	5.071	9.47	3.452	0.0100	
			5.071	6.690	6.04	5.071	0.0000	
			6.690	8.310	2.61	6.690	0.0000	
			8.310	9.929	5.12	9.929	0.0000	
			9.929	11.548	8.55	11.548	0.0100	
			11.548	13.167	11.98	13.167	0.0100	
3	14.00	15.94	1.833	4.167	17.08	1.833	0.0100	
			4.167	6.500	12.13	4.167	0.0100	
			6.500	8.833	7.18	6.500	0.0000	
			8.833	11.167	2.86	11.167	0.0000	
			11.167	13.500	7.80	13.500	0.0000	
			13.500	15.833	12.75	15.833	0.0100	
			15.833	18.167	17.70	18.167	0.0100	

Longitudinal Beam Shear Reinforcement Details:

Units: spacing & distance (in).
Span Size Stirrups (2 legs each unless otherwise noted)

- 1 #3 19 @ 6.7 + <-- 36.6 --> + 19 @ 6.7
- 2 #3 9 @ 6.2 + <-- 58.3 --> + 9 @ 6.2
- 3 #3 11 @ 6.7 + <-- 84.0 --> + 11 @ 6.7

Beam Shear Capacity:

```

=====
Units: d, Sp (in), Start, End, Xu (ft), PhiVc, PhiVn, Vu (kip), Av/s (in^2/in)
Span      d      PhiVc      Start      End      Av/s      Sp      PhiVn      Vu      Xu
-----
1      14.00      15.94      0.000      0.917      -----      -----      36.60      26.88      0.000
           0.917      10.976      0.0328      -----      6.7      36.60      22.99      1.833
           10.976      14.024      -----      -----      7.97      3.61      10.976
           14.024      24.083      0.0328      -----      6.7      36.60      22.34      23.167
           24.083      25.000      -----      -----      36.60      26.22      25.000

2      14.00      15.94      0.000      0.917      -----      -----      38.18      16.79      0.000
           0.917      5.071      0.0353      -----      6.2      38.18      12.91      1.833
           5.071      9.929      -----      -----      7.97      6.04      5.071
           9.929      14.083      0.0353      -----      6.2      38.18      11.98      13.167
           14.083      15.000      -----      -----      38.18      15.87      15.000

3      14.00      15.94      0.000      0.917      -----      -----      36.62      20.96      0.000
           0.917      6.500      0.0328      -----      6.7      36.62      17.08      1.833
           6.500      13.500      -----      -----      7.97      7.80      13.500
           13.500      19.083      0.0328      -----      6.7      36.62      17.70      18.167
           19.083      20.000      -----      -----      36.62      21.59      20.000
    
```

Slab Shear Capacity:

```

=====
Units: b, d (in), Xu (ft), PhiVc, Vu(kip)
Span      b      d      Vratio      PhiVc      Vu      Xu
-----
1      --- Not checked ---
2      --- Not checked ---
3      --- Not checked ---
    
```

Maximum Deflections:

```

=====
Units: Dz (in)
Span Dz(DEAD) Dz(LIVE) Dz(TOTAL)
-----
1      -0.401      -0.171      -0.572
2      -0.009      -0.005      -0.013
3      -0.143      -0.099      -0.241
    
```

Material Takeoff:

```

=====
Reinforcement in the Direction of Analysis
Top Bars:      150.9 lb <=> 2.51 lb/ft <=> 2.515 lb/ft^2
Bottom Bars:   161.9 lb <=> 2.70 lb/ft <=> 2.698 lb/ft^2
Stirrups:      322.6 lb <=> 5.38 lb/ft <=> 5.377 lb/ft^2
Total Steel:   635.4 lb <=> 10.59 lb/ft <=> 10.589 lb/ft^2
Concrete:      80.0 ft^3 <=> 1.33 ft^3/ft <=> 1.333 ft^3/ft^2
    
```

[3] REDISTRIBUTED COLUMN AXIAL FORCES AND MOMENTS

```

=====
Units: P (kip), M (k-ft)
Supp Case/Patt      P (axial)      Mb[top]      Ma[bottom]
-----
1 SELF              2.53           -4.71         -4.71
Dead                14.75          -27.48        -27.48
Live/All            5.69           -10.60        -10.60
    
```

Live/Odd	5.74	-10.81	-10.81
Live/Even	-0.05	0.22	0.22
Live/S1	5.73	-10.78	-10.78
Live/S2	5.68	-10.56	-10.56
Live/S3	-0.04	0.18	0.18
Live/S4	0.01	-0.03	-0.03
2 SELF	4.02	2.45	2.45
Dead	23.49	14.32	14.32
Live/All	9.06	5.52	5.52
Live/Odd	5.63	8.15	8.15
Live/Even	3.42	-2.63	-2.63
Live/S1	5.87	7.74	7.74
Live/S2	9.27	5.12	5.12
Live/S3	3.21	-2.22	-2.22
Live/S4	-0.23	0.51	0.51
3 SELF	3.42	-1.16	-1.16
Dead	19.97	-6.75	-6.75
Live/All	7.70	-2.60	-2.60
Live/Odd	4.25	-5.19	-5.19
Live/Even	3.45	2.59	2.59
Live/S1	-0.37	-0.79	-0.79
Live/S2	3.10	1.96	1.96
Live/S3	8.05	-1.97	-1.97
Live/S4	4.61	-4.56	-4.56
4 SELF	2.03	2.92	2.92
Dead	11.82	17.04	17.04
Live/All	4.56	6.57	6.57
Live/Odd	4.63	6.83	6.83
Live/Even	-0.07	-0.26	-0.26
Live/S1	0.02	0.06	0.06
Live/S2	-0.05	-0.19	-0.19
Live/S3	4.54	6.51	6.51
Live/S4	4.61	6.77	6.77
Sum SELF	12.00	-0.49	-0.49
Dead	70.02	-2.86	-2.86
Live/All	27.00	-1.10	-1.10
Live/Odd	20.25	-1.03	-1.03
Live/Even	6.75	-0.08	-0.08
Live/S1	11.25	-3.76	-3.76
Live/S2	18.00	-3.68	-3.68
Live/S3	15.75	2.50	2.50
Live/S4	9.00	2.68	2.68

=====

[3a] NON-REDISTRIBUTED COLUMN AXIAL FORCES AND MOMENTS

=====

Units: P (kip), M (k-ft)

Supp Case/Patt	P (axial)	Mb[top]	Ma[bottom]
1 SELF	2.46	-4.71	-4.71
Dead	14.38	-27.48	-27.48
Live/All	5.55	-10.60	-10.60
Live/Odd	5.60	-10.81	-10.81
Live/Even	-0.06	0.22	0.22
Live/S1	5.59	-10.78	-10.78
Live/S2	5.54	-10.56	-10.56
Live/S3	-0.05	0.18	0.18
Live/S4	0.01	-0.03	-0.03
2 SELF	4.10	2.76	2.76
Dead	23.93	16.12	16.12
Live/All	9.23	6.22	6.22
Live/Odd	5.80	9.53	9.53

Live/Even	3.43	-3.31	-3.31
Live/S1	6.07	9.02	9.02
Live/S2	9.50	5.70	5.70
Live/S3	3.16	-2.80	-2.80
Live/S4	-0.27	0.51	0.51
3 SELF	3.48	-1.45	-1.45
Dead	20.28	-8.43	-8.43
Live/All	7.82	-3.25	-3.25
Live/Odd	4.36	-6.49	-6.49
Live/Even	3.46	3.24	3.24
Live/S1	-0.43	-0.79	-0.79
Live/S2	3.03	2.45	2.45
Live/S3	8.25	-2.46	-2.46
Live/S4	4.79	-5.70	-5.70
4 SELF	1.96	2.92	2.92
Dead	11.43	17.04	17.04
Live/All	4.41	6.57	6.57
Live/Odd	4.49	6.83	6.83
Live/Even	-0.08	-0.26	-0.26
Live/S1	0.02	0.06	0.06
Live/S2	-0.06	-0.19	-0.19
Live/S3	4.39	6.51	6.51
Live/S4	4.47	6.77	6.77
Sum SELF	12.00	-0.47	-0.47
Dead	70.02	-2.75	-2.75
Live/All	27.00	-1.06	-1.06
Live/Odd	20.25	-0.95	-0.95
Live/Even	6.75	-0.11	-0.11
Live/S1	11.25	-2.49	-2.49
Live/S2	18.00	-2.60	-2.60
Live/S3	15.75	1.43	1.43
Live/S4	9.00	1.54	1.54

=====

[6] REDISTRIBUTED SEGMENTAL MOMENT AND SHEAR - ENVELOPES

=====

Span	x (ft)	M- (k-ft) Comb	M+ (k-ft) Comb	V- (kip) Comb	V+ (kip) Comb
1	0.000	-100.54 U1	0.00 U1	0.00 U1	26.88 U1
	0.222	-94.62 U1	0.00 U1	0.00 U1	26.41 U1
	0.444	-88.81 U1	0.00 U1	0.00 U1	25.94 U1
	0.667	-83.10 U1	0.00 U1	0.00 U1	25.47 U1
	0.667	-83.10 U1	0.00 U1	0.00 U1	25.47 U1
	0.916	-76.82 U1	0.00 U1	0.00 U1	24.94 U1
	1.165	-70.67 U1	0.00 U1	0.00 U1	24.41 U1
	1.414	-64.66 U1	0.00 U1	0.00 U1	23.88 U1
	1.663	-58.77 U1	0.00 U1	0.00 U1	23.35 U1
	1.912	-53.02 U1	0.00 U1	0.00 U1	22.82 U1
	2.161	-47.40 U1	0.00 U1	0.00 U1	22.30 U1
	2.411	-41.91 U1	0.00 U1	0.00 U1	21.77 U1
	2.660	-36.55 U1	0.00 U1	0.00 U1	21.24 U1
	2.909	-31.33 U1	0.00 U1	0.00 U1	20.71 U1
	3.158	-26.23 U1	0.00 U1	0.00 U1	20.18 U1
	3.407	-21.27 U1	0.00 U1	0.00 U1	19.66 U1
	3.656	-16.44 U1	0.00 U1	0.00 U1	19.13 U1
	3.905	-11.74 U1	0.00 U1	0.00 U1	18.60 U1
	4.154	-7.17 U1	0.00 U1	0.00 U1	18.07 U1
	4.404	-2.74 U1	0.00 U1	0.00 U1	17.54 U1
	4.653	0.00 U1	1.94 U1	0.00 U1	17.01 U1
	4.902	0.00 U1	6.09 U1	0.00 U1	16.49 U1
	5.151	0.00 U1	10.10 U1	0.00 U1	15.96 U1
	5.400	0.00 U1	13.99 U1	0.00 U1	15.43 U1
	5.649	0.00 U1	17.75 U1	0.00 U1	14.90 U1

5.898	0.00 U1	21.37 U1	0.00 U1	14.37 U1
6.147	0.00 U1	24.86 U1	0.00 U1	13.84 U1
6.396	0.00 U1	28.22 U1	0.00 U1	13.32 U1
6.646	0.00 U1	31.45 U1	0.00 U1	12.79 U1
6.895	0.00 U1	34.55 U1	0.00 U1	12.26 U1
7.144	0.00 U1	37.51 U1	0.00 U1	11.73 U1
7.393	0.00 U1	40.35 U1	0.00 U1	11.20 U1
7.642	0.00 U1	43.05 U1	0.00 U1	10.68 U1
7.891	0.00 U1	45.62 U1	0.00 U1	10.15 U1
8.140	0.00 U1	48.06 U1	0.00 U1	9.62 U1
8.389	0.00 U1	50.37 U1	0.00 U1	9.09 U1
8.639	0.00 U1	52.54 U1	0.00 U1	8.56 U1
8.888	0.00 U1	54.61 U1	0.00 U1	8.03 U1
9.137	0.00 U1	56.54 U1	0.00 U1	7.51 U1
9.386	0.00 U1	58.35 U1	0.00 U1	6.98 U1
9.635	0.00 U1	60.02 U1	0.00 U1	6.45 U1
9.884	0.00 U1	61.56 U1	0.00 U1	5.92 U1
10.133	0.00 U1	62.97 U1	0.00 U1	5.39 U1
10.382	0.00 U1	64.25 U1	0.00 U1	4.86 U1
10.632	0.00 U1	65.39 U1	0.00 U1	4.34 U1
10.881	0.00 U1	66.41 U1	0.00 U1	3.81 U1
11.130	0.00 U1	67.29 U1	0.00 U1	3.28 U1
11.379	0.00 U1	68.04 U1	0.00 U1	2.75 U1
11.628	0.00 U1	68.66 U1	0.00 U1	2.22 U1
11.877	0.00 U1	69.15 U1	0.00 U1	1.70 U1
12.126	0.00 U1	69.51 U1	0.00 U1	1.17 U1
12.375	0.00 U1	69.73 U1	0.00 U1	0.64 U1
12.625	0.00 U1	69.82 U1	-0.06 U1	0.11 U1
12.874	0.00 U1	69.79 U1	-0.51 U1	0.00 U1
13.123	0.00 U1	69.62 U1	-1.04 U1	0.00 U1
13.372	0.00 U1	69.32 U1	-1.57 U1	0.00 U1
13.621	0.00 U1	68.88 U1	-2.09 U1	0.00 U1
13.870	0.00 U1	68.32 U1	-2.62 U1	0.00 U1
14.119	0.00 U1	67.62 U1	-3.15 U1	0.00 U1
14.368	0.00 U1	66.79 U1	-3.68 U1	0.00 U1
14.618	0.00 U1	65.83 U1	-4.21 U1	0.00 U1
14.867	0.00 U1	64.74 U1	-4.74 U1	0.00 U1
15.116	0.00 U1	63.52 U1	-5.26 U1	0.00 U1
15.365	0.00 U1	62.17 U1	-5.79 U1	0.00 U1
15.614	0.00 U1	60.68 U1	-6.32 U1	0.00 U1
15.863	0.00 U1	59.06 U1	-6.85 U1	0.00 U1
16.112	0.00 U1	57.31 U1	-7.38 U1	0.00 U1
16.361	0.00 U1	55.43 U1	-7.91 U1	0.00 U1
16.611	0.00 U1	53.42 U1	-8.43 U1	0.00 U1
16.860	0.00 U1	51.28 U1	-8.96 U1	0.00 U1
17.109	0.00 U1	49.00 U1	-9.49 U1	0.00 U1
17.358	0.00 U1	46.59 U1	-10.02 U1	0.00 U1
17.607	0.00 U1	44.06 U1	-10.55 U1	0.00 U1
17.856	0.00 U1	41.39 U1	-11.07 U1	0.00 U1
18.105	0.00 U1	38.58 U1	-11.60 U1	0.00 U1
18.354	0.00 U1	35.65 U1	-12.13 U1	0.00 U1
18.604	0.00 U1	32.59 U1	-12.66 U1	0.00 U1
18.853	0.00 U1	29.39 U1	-13.19 U1	0.00 U1
19.102	0.00 U1	26.06 U1	-13.72 U1	0.00 U1
19.351	0.00 U1	22.60 U1	-14.24 U1	0.00 U1
19.600	0.00 U1	19.01 U1	-14.77 U1	0.00 U1
19.849	0.00 U1	15.29 U1	-15.30 U1	0.00 U1
20.098	0.00 U1	11.43 U1	-15.83 U1	0.00 U1
20.347	0.00 U1	7.45 U1	-16.36 U1	0.00 U1
20.596	0.00 U1	3.33 U1	-16.89 U1	0.00 U1
20.846	-2.22 U1	0.00 U1	-17.41 U1	0.00 U1
21.095	-6.45 U1	0.00 U1	-17.94 U1	0.00 U1
21.344	-10.98 U1	0.00 U1	-18.47 U1	0.00 U1
21.593	-15.65 U1	0.00 U1	-19.00 U1	0.00 U1
21.842	-20.45 U1	0.00 U1	-19.53 U1	0.00 U1
22.091	-25.38 U1	0.00 U1	-20.05 U1	0.00 U1
22.340	-30.44 U1	0.00 U1	-20.58 U1	0.00 U1
22.589	-35.63 U1	0.00 U1	-21.11 U1	0.00 U1

22.839	-40.96 U1	0.00 U1	-21.64 U1	0.00 U1
23.088	-46.42 U1	0.00 U1	-22.17 U1	0.00 U1
23.337	-52.00 U1	0.00 U1	-22.70 U1	0.00 U1
23.586	-57.72 U1	0.00 U1	-23.22 U1	0.00 U1
23.835	-63.58 U1	0.00 U1	-23.75 U1	0.00 U1
24.084	-69.56 U1	0.00 U1	-24.28 U1	0.00 U1
24.333	-75.67 U1	0.00 U1	-24.81 U1	0.00 U1
24.333	-75.67 U1	0.00 U1	-24.81 U1	0.00 U1
24.556	-81.24 U1	0.00 U1	-25.28 U1	0.00 U1
24.778	-86.91 U1	0.00 U1	-25.75 U1	0.00 U1
25.000	-92.68 U1	0.00 U1	-26.22 U1	0.00 U1

=====

[6a] NON-REDISTRIBUTED SEGMENTAL MOMENT AND SHEAR - ENVELOPES

=====

Span	x (ft)	M- (k-ft) Comb	M+ (k-ft) Comb	V- (kip) Comb	V+ (kip) Comb
1	0.000	-100.54 U1	0.00 U1	0.00 U1	26.22 U1
	0.222	-94.77 U1	0.00 U1	0.00 U1	25.75 U1
	0.444	-89.10 U1	0.00 U1	0.00 U1	25.28 U1
	0.667	-83.53 U1	0.00 U1	0.00 U1	24.81 U1
	0.667	-83.53 U1	0.00 U1	0.00 U1	24.81 U1
	0.916	-77.42 U1	0.00 U1	0.00 U1	24.28 U1
	1.165	-71.44 U1	0.00 U1	0.00 U1	23.75 U1
	1.414	-65.58 U1	0.00 U1	0.00 U1	23.22 U1
	1.663	-59.86 U1	0.00 U1	0.00 U1	22.70 U1
	1.912	-54.28 U1	0.00 U1	0.00 U1	22.17 U1
	2.161	-48.82 U1	0.00 U1	0.00 U1	21.64 U1
	2.411	-43.49 U1	0.00 U1	0.00 U1	21.11 U1
	2.660	-38.30 U1	0.00 U1	0.00 U1	20.58 U1
	2.909	-33.24 U1	0.00 U1	0.00 U1	20.05 U1
	3.158	-28.31 U1	0.00 U1	0.00 U1	19.53 U1
	3.407	-23.51 U1	0.00 U1	0.00 U1	19.00 U1
	3.656	-18.84 U1	0.00 U1	0.00 U1	18.47 U1
	3.905	-14.31 U1	0.00 U1	0.00 U1	17.94 U1
	4.154	-9.90 U1	0.00 U1	0.00 U1	17.41 U1
	4.404	-5.63 U1	0.00 U1	0.00 U1	16.89 U1
	4.653	-1.49 U1	0.00 U1	0.00 U1	16.36 U1
	4.902	0.00 U1	2.81 U1	0.00 U1	15.83 U1
	5.151	0.00 U1	6.66 U1	0.00 U1	15.30 U1
	5.400	0.00 U1	10.39 U1	0.00 U1	14.77 U1
	5.649	0.00 U1	13.97 U1	0.00 U1	14.24 U1
	5.898	0.00 U1	17.43 U1	0.00 U1	13.72 U1
	6.147	0.00 U1	20.76 U1	0.00 U1	13.19 U1
	6.396	0.00 U1	23.95 U1	0.00 U1	12.66 U1
	6.646	0.00 U1	27.01 U1	0.00 U1	12.13 U1
	6.895	0.00 U1	29.94 U1	0.00 U1	11.60 U1
	7.144	0.00 U1	32.74 U1	0.00 U1	11.07 U1
	7.393	0.00 U1	35.41 U1	0.00 U1	10.55 U1
	7.642	0.00 U1	37.95 U1	0.00 U1	10.02 U1
	7.891	0.00 U1	40.36 U1	0.00 U1	9.49 U1
	8.140	0.00 U1	42.66 U1	0.00 U1	8.96 U1
	8.389	0.00 U1	44.83 U1	0.00 U1	8.43 U1
	8.639	0.00 U1	46.87 U1	0.00 U1	7.91 U1
	8.888	0.00 U1	48.77 U1	0.00 U1	7.38 U1
	9.137	0.00 U1	50.54 U1	0.00 U1	6.85 U1
	9.386	0.00 U1	52.18 U1	0.00 U1	6.32 U1
	9.635	0.00 U1	53.69 U1	0.00 U1	5.79 U1
	9.884	0.00 U1	55.07 U1	0.00 U1	5.26 U1
	10.133	0.00 U1	56.31 U1	0.00 U1	4.74 U1
	10.382	0.00 U1	57.43 U1	0.00 U1	4.21 U1
	10.632	0.00 U1	58.41 U1	0.00 U1	3.68 U1
	10.881	0.00 U1	59.26 U1	0.00 U1	3.15 U1
	11.130	0.00 U1	59.98 U1	0.00 U1	2.62 U1
	11.379	0.00 U1	60.57 U1	0.00 U1	2.09 U1
	11.628	0.00 U1	61.02 U1	0.00 U1	1.57 U1
	11.877	0.00 U1	61.35 U1	0.00 U1	1.04 U1

12.126	0.00 U1	61.54 U1	0.00 U1	0.51 U1
12.375	0.00 U1	61.60 U1	-0.16 U1	0.00 U1
12.625	0.00 U1	61.53 U1	-0.65 U1	0.00 U1
12.874	0.00 U1	61.33 U1	-1.18 U1	0.00 U1
13.123	0.00 U1	61.00 U1	-1.71 U1	0.00 U1
13.372	0.00 U1	60.53 U1	-2.23 U1	0.00 U1
13.621	0.00 U1	59.93 U1	-2.76 U1	0.00 U1
13.870	0.00 U1	59.21 U1	-3.29 U1	0.00 U1
14.119	0.00 U1	58.35 U1	-3.82 U1	0.00 U1
14.368	0.00 U1	57.35 U1	-4.35 U1	0.00 U1
14.618	0.00 U1	56.23 U1	-4.88 U1	0.00 U1
14.867	0.00 U1	54.98 U1	-5.40 U1	0.00 U1
15.116	0.00 U1	53.59 U1	-5.93 U1	0.00 U1
15.365	0.00 U1	52.07 U1	-6.46 U1	0.00 U1
15.614	0.00 U1	50.42 U1	-6.99 U1	0.00 U1
15.863	0.00 U1	48.64 U1	-7.52 U1	0.00 U1
16.112	0.00 U1	46.73 U1	-8.04 U1	0.00 U1
16.361	0.00 U1	44.69 U1	-8.57 U1	0.00 U1
16.611	0.00 U1	42.51 U1	-9.10 U1	0.00 U1
16.860	0.00 U1	40.20 U1	-9.63 U1	0.00 U1
17.109	0.00 U1	37.76 U1	-10.16 U1	0.00 U1
17.358	0.00 U1	35.19 U1	-10.69 U1	0.00 U1
17.607	0.00 U1	32.49 U1	-11.21 U1	0.00 U1
17.856	0.00 U1	29.66 U1	-11.74 U1	0.00 U1
18.105	0.00 U1	26.69 U1	-12.27 U1	0.00 U1
18.354	0.00 U1	23.59 U1	-12.80 U1	0.00 U1
18.604	0.00 U1	20.37 U1	-13.33 U1	0.00 U1
18.853	0.00 U1	17.00 U1	-13.86 U1	0.00 U1
19.102	0.00 U1	13.51 U1	-14.38 U1	0.00 U1
19.351	0.00 U1	9.89 U1	-14.91 U1	0.00 U1
19.600	0.00 U1	6.13 U1	-15.44 U1	0.00 U1
19.849	-0.31 U1	2.25 U1	-15.97 U1	0.00 U1
20.098	-3.04 U1	0.00 U1	-16.50 U1	0.00 U1
20.347	-7.22 U1	0.00 U1	-17.02 U1	0.00 U1
20.596	-11.52 U1	0.00 U1	-17.55 U1	0.00 U1
20.846	-15.96 U1	0.00 U1	-18.08 U1	0.00 U1
21.095	-20.53 U1	0.00 U1	-18.61 U1	0.00 U1
21.344	-25.23 U1	0.00 U1	-19.14 U1	0.00 U1
21.593	-30.07 U1	0.00 U1	-19.67 U1	0.00 U1
21.842	-35.03 U1	0.00 U1	-20.19 U1	0.00 U1
22.091	-40.13 U1	0.00 U1	-20.72 U1	0.00 U1
22.340	-45.36 U1	0.00 U1	-21.25 U1	0.00 U1
22.589	-50.72 U1	0.00 U1	-21.78 U1	0.00 U1
22.839	-56.21 U1	0.00 U1	-22.31 U1	0.00 U1
23.088	-61.83 U1	0.00 U1	-22.84 U1	0.00 U1
23.337	-67.59 U1	0.00 U1	-23.36 U1	0.00 U1
23.586	-73.47 U1	0.00 U1	-23.89 U1	0.00 U1
23.835	-79.49 U1	0.00 U1	-24.42 U1	0.00 U1
24.084	-85.64 U1	0.00 U1	-24.95 U1	0.00 U1
24.333	-91.92 U1	0.00 U1	-25.48 U1	0.00 U1
24.333	-91.92 U1	0.00 U1	-25.48 U1	0.00 U1
24.556	-97.64 U1	0.00 U1	-25.95 U1	0.00 U1
24.778	-103.45 U1	0.00 U1	-26.42 U1	0.00 U1
25.000	-109.38 U1	0.00 U1	-26.89 U1	0.00 U1

=====

[7] SEGMENTAL DEFLECTIONS

=====

Units: x (ft), Dz (in)				
Span	x	Dz (DEAD)	Dz (LIVE)	Dz (TOTAL)
1	0.000	-0.000	-0.000	-0.000
	0.222	-0.002	-0.001	-0.002
	0.444	-0.004	-0.001	-0.005
	0.667	-0.006	-0.002	-0.009
	0.667	-0.006	-0.002	-0.009
	0.916	-0.010	-0.003	-0.013

1.165	-0.015	-0.005	-0.020
1.414	-0.020	-0.007	-0.027
1.663	-0.026	-0.010	-0.036
1.912	-0.034	-0.013	-0.046
2.161	-0.042	-0.016	-0.058
2.411	-0.050	-0.020	-0.070
2.660	-0.060	-0.023	-0.083
2.909	-0.069	-0.028	-0.097
3.158	-0.080	-0.032	-0.112
3.407	-0.090	-0.037	-0.127
3.656	-0.102	-0.041	-0.143
3.905	-0.113	-0.046	-0.159
4.154	-0.125	-0.051	-0.176
4.404	-0.137	-0.056	-0.193
4.653	-0.149	-0.061	-0.210
4.902	-0.161	-0.067	-0.228
5.151	-0.173	-0.072	-0.246
5.400	-0.186	-0.077	-0.263
5.649	-0.198	-0.083	-0.281
5.898	-0.210	-0.088	-0.298
6.147	-0.222	-0.093	-0.316
6.396	-0.234	-0.098	-0.333
6.646	-0.246	-0.104	-0.350
6.895	-0.258	-0.109	-0.366
7.144	-0.269	-0.114	-0.383
7.393	-0.280	-0.118	-0.399
7.642	-0.291	-0.123	-0.414
7.891	-0.301	-0.128	-0.429
8.140	-0.311	-0.132	-0.443
8.389	-0.321	-0.136	-0.457
8.639	-0.330	-0.140	-0.470
8.888	-0.339	-0.144	-0.482
9.137	-0.347	-0.147	-0.494
9.386	-0.354	-0.151	-0.505
9.635	-0.361	-0.154	-0.515
9.884	-0.368	-0.157	-0.525
10.133	-0.374	-0.159	-0.533
10.382	-0.379	-0.162	-0.541
10.632	-0.384	-0.164	-0.548
10.881	-0.388	-0.166	-0.554
11.130	-0.392	-0.167	-0.559
11.379	-0.395	-0.169	-0.564
11.628	-0.397	-0.170	-0.567
11.877	-0.399	-0.170	-0.570
12.126	-0.400	-0.171	-0.571
12.375	-0.401	-0.171	-0.572
12.625	-0.400	-0.171	-0.572
12.874	-0.400	-0.171	-0.570
13.123	-0.398	-0.170	-0.568
13.372	-0.396	-0.169	-0.565
13.621	-0.393	-0.168	-0.561
13.870	-0.390	-0.167	-0.556
14.119	-0.386	-0.165	-0.551
14.368	-0.381	-0.163	-0.544
14.618	-0.376	-0.161	-0.536
14.867	-0.370	-0.158	-0.528
15.116	-0.364	-0.155	-0.519
15.365	-0.357	-0.152	-0.509
15.614	-0.349	-0.149	-0.498
15.863	-0.341	-0.146	-0.487
16.112	-0.333	-0.142	-0.475
16.361	-0.324	-0.138	-0.462
16.611	-0.315	-0.134	-0.448
16.860	-0.305	-0.130	-0.434
17.109	-0.294	-0.125	-0.420
17.358	-0.284	-0.121	-0.405
17.607	-0.273	-0.116	-0.389
17.856	-0.262	-0.111	-0.373

18.105	-0.250	-0.106	-0.356
18.354	-0.239	-0.101	-0.340
18.604	-0.227	-0.096	-0.322
18.853	-0.214	-0.091	-0.305
19.102	-0.202	-0.085	-0.288
19.351	-0.190	-0.080	-0.270
19.600	-0.178	-0.075	-0.252
19.849	-0.165	-0.069	-0.235
20.098	-0.153	-0.064	-0.217
20.347	-0.141	-0.059	-0.200
20.596	-0.129	-0.054	-0.182
20.846	-0.117	-0.049	-0.166
21.095	-0.105	-0.044	-0.149
21.344	-0.094	-0.039	-0.133
21.593	-0.083	-0.034	-0.117
21.842	-0.073	-0.030	-0.102
22.091	-0.063	-0.025	-0.088
22.340	-0.053	-0.021	-0.075
22.589	-0.044	-0.018	-0.062
22.839	-0.036	-0.014	-0.050
23.088	-0.029	-0.011	-0.040
23.337	-0.022	-0.008	-0.030
23.586	-0.016	-0.006	-0.022
23.835	-0.011	-0.004	-0.015
24.084	-0.007	-0.003	-0.010
24.333	-0.004	-0.002	-0.006
24.333	-0.004	-0.002	-0.006
24.556	-0.003	-0.001	-0.004
24.778	-0.001	-0.000	-0.002
25.000	-0.000	-0.000	-0.000

Graphical Output

Loads

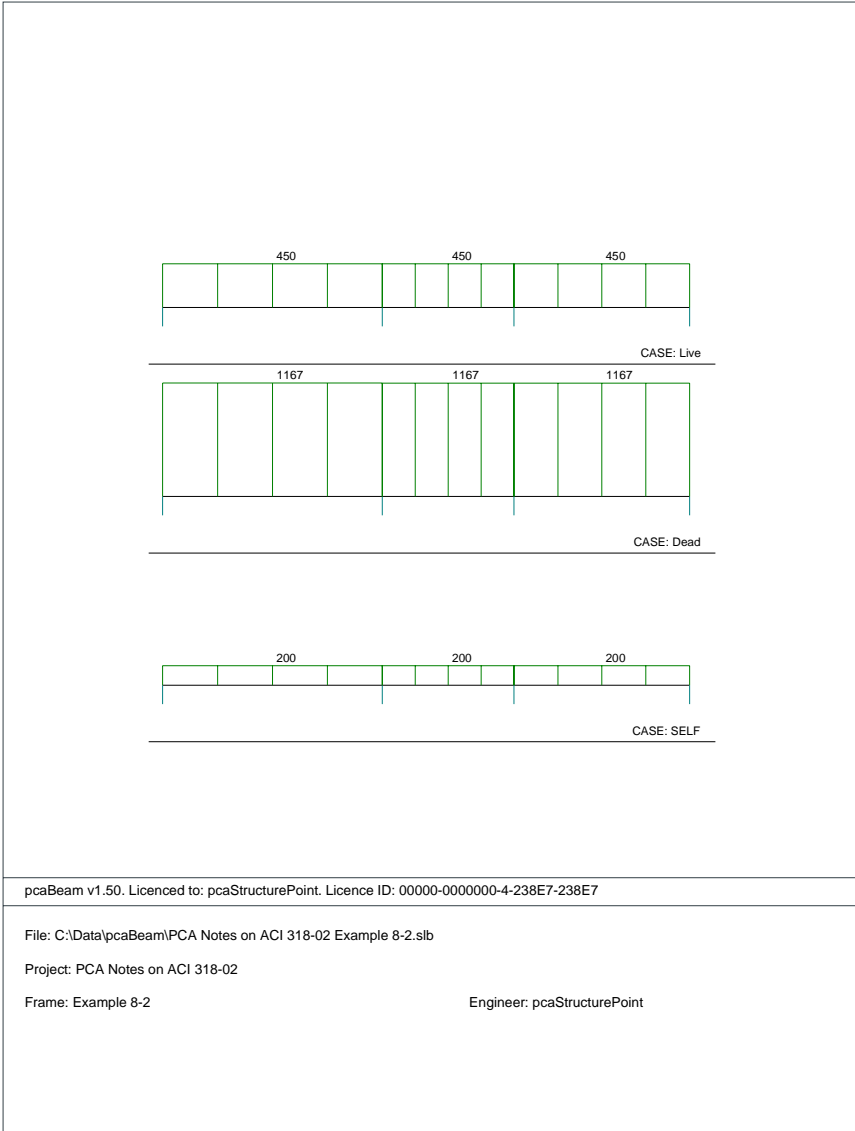

Internal Forces

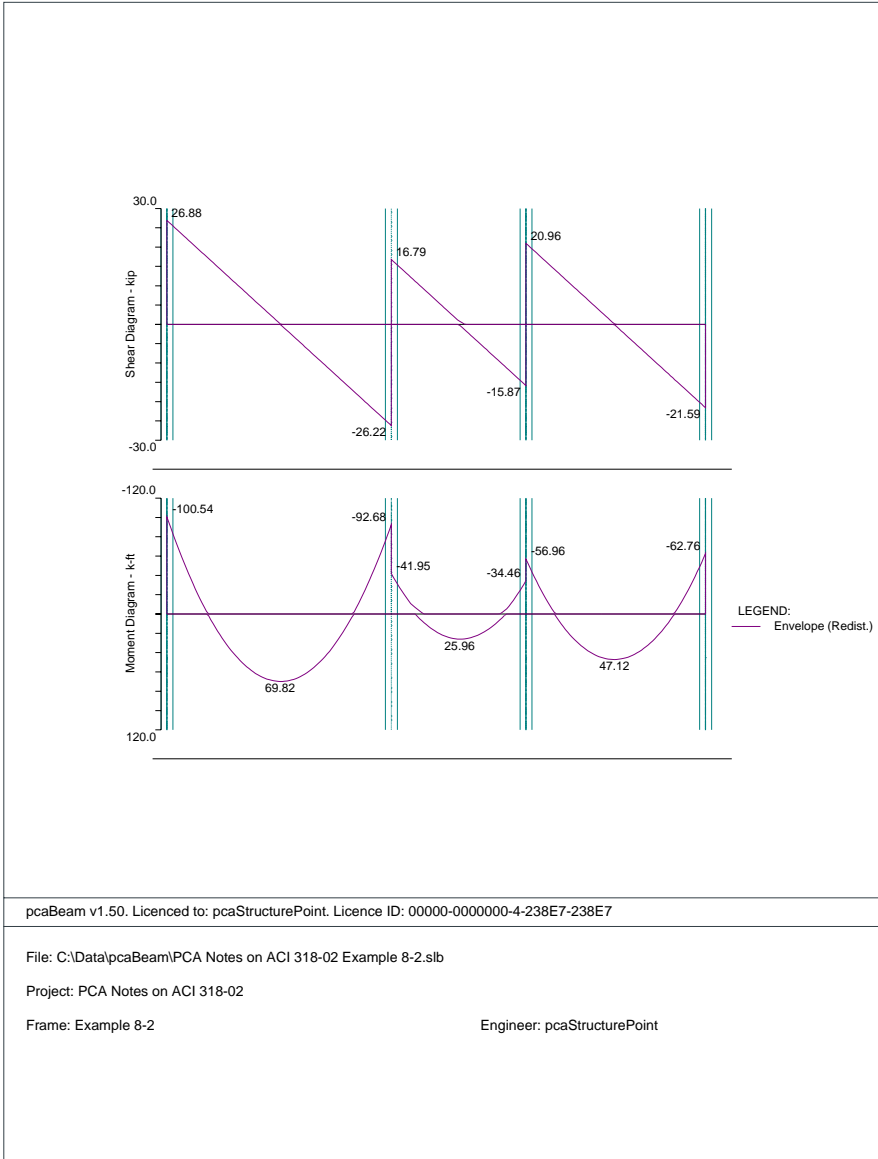

Moment Capacity

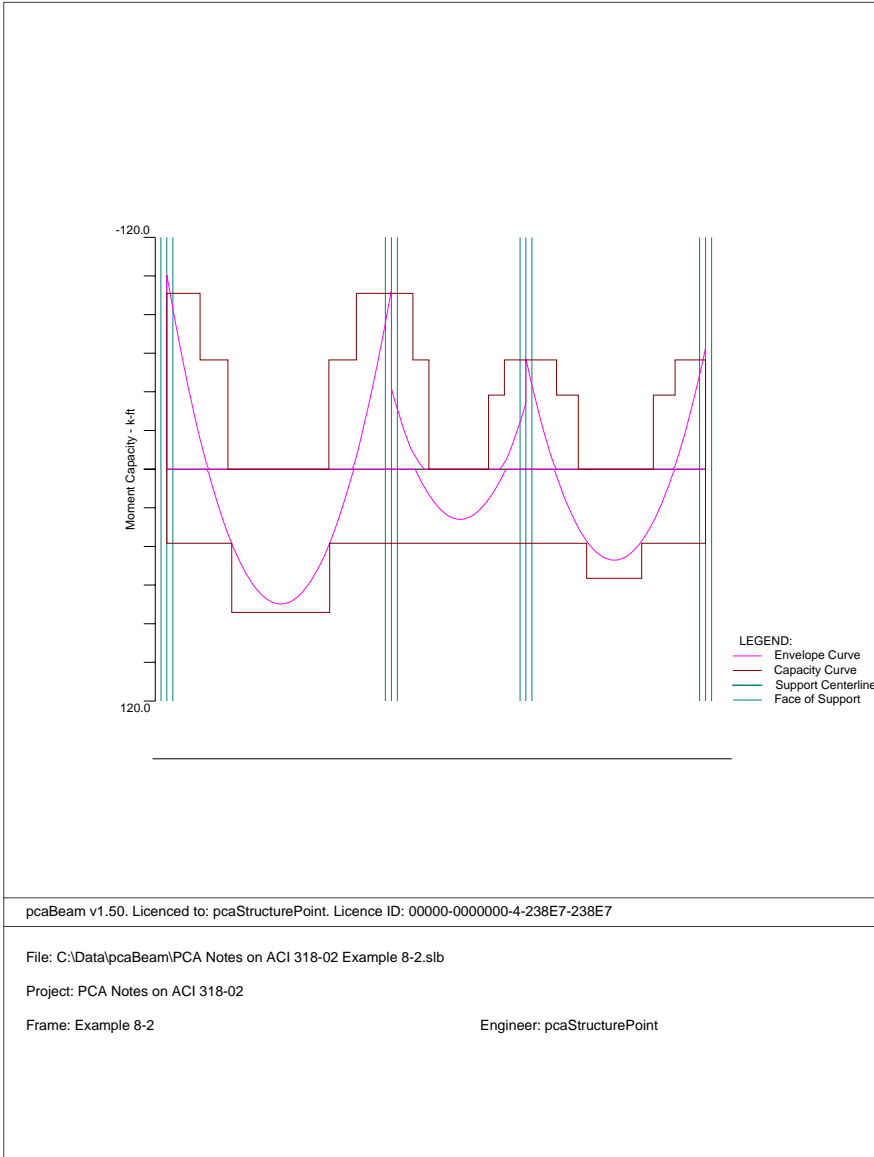

Shear Capacity

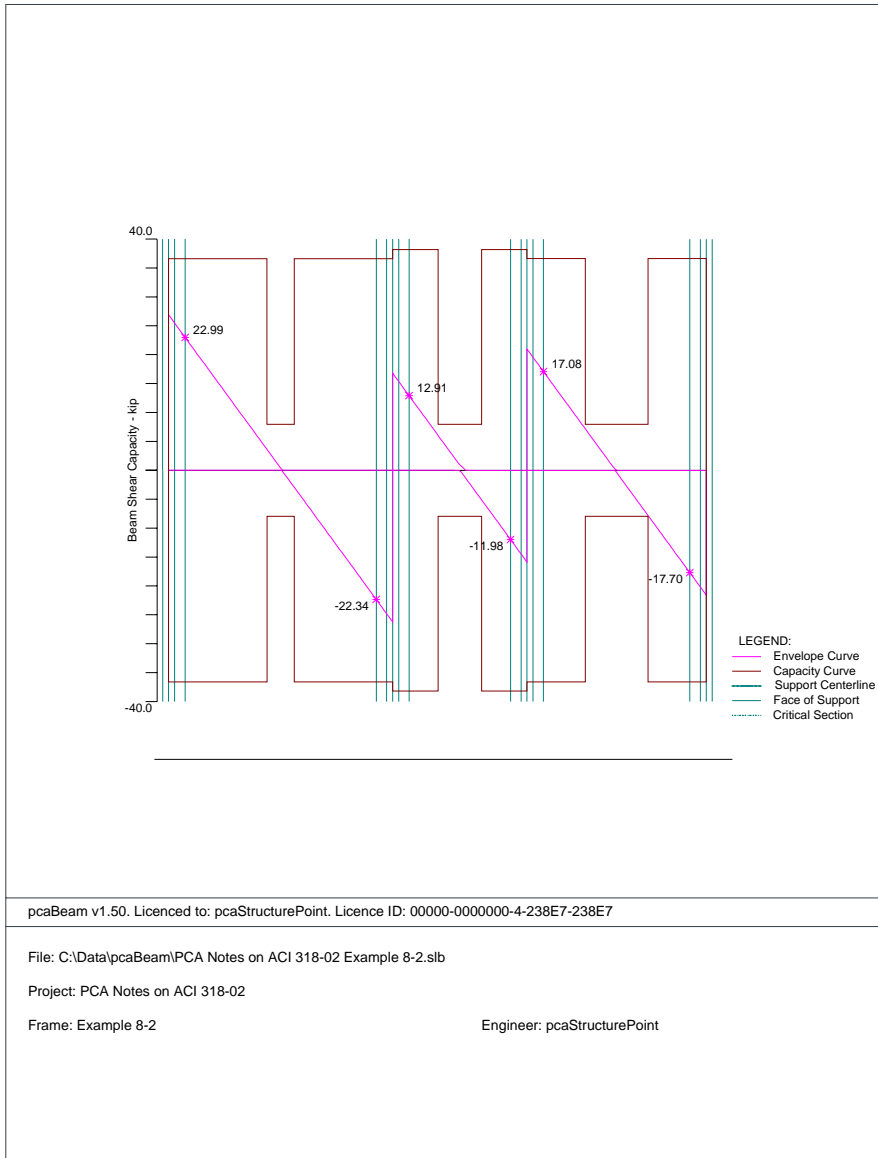

Deflection

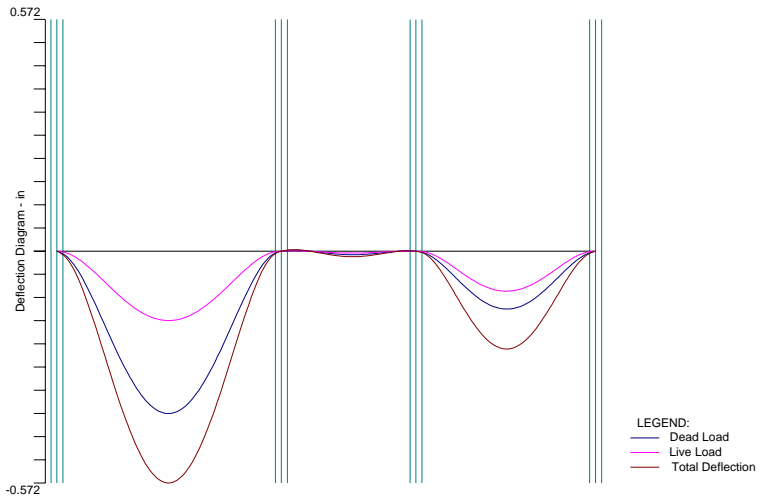

pcaBeam v1.50. Licenced to: pcaStructurePoint. Licence ID: 00000-0000000-4-238E7-238E7

File: C:\Data\pcaBeam\PCA Notes on ACI 318-02 Example 8-2.sib

Project: PCA Notes on ACI 318-02

Frame: Example 8-2

Engineer: pcaStructurePoint

Reinforcement



Example 2 Spandrel beam with torsion

Problem description

Design a precast, nonprestressed concrete spandrel beam for combined shear and torsion. Roof members are simply supported on spandrel ledge. Spandrel beams are connected to columns to transfer torsion. Continuity between spandrel beams is not provided. This example refers to Example 13-1 from *PCA Notes on ACI 318-02 Building Code Requirements for Structural Concrete*, Portland Cement Association, 2002.

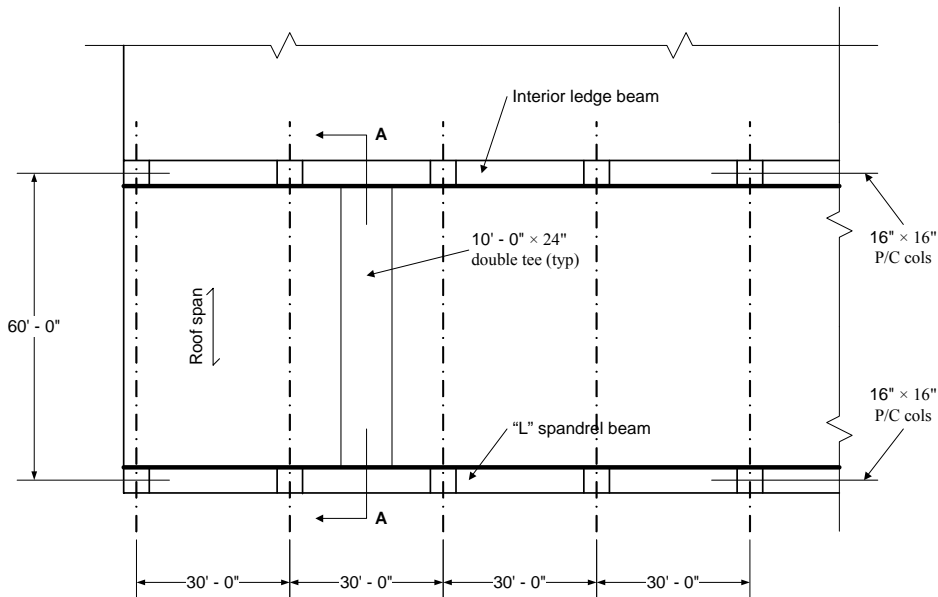

Partial plan of precast roof system

Design Criteria:

Live load	=	30 lb/ft ²
Dead Load	=	64 lb/ft ²
f'_c	=	5000 psi ($w_c = 150$ pcf)
f_y	=	60,000 psi

Roof members are 10 ft wide double tee units, 24 in. deep. Design of these units is not included in this design example. For lateral support, alternate ends of roof members are fixed to supporting beams.

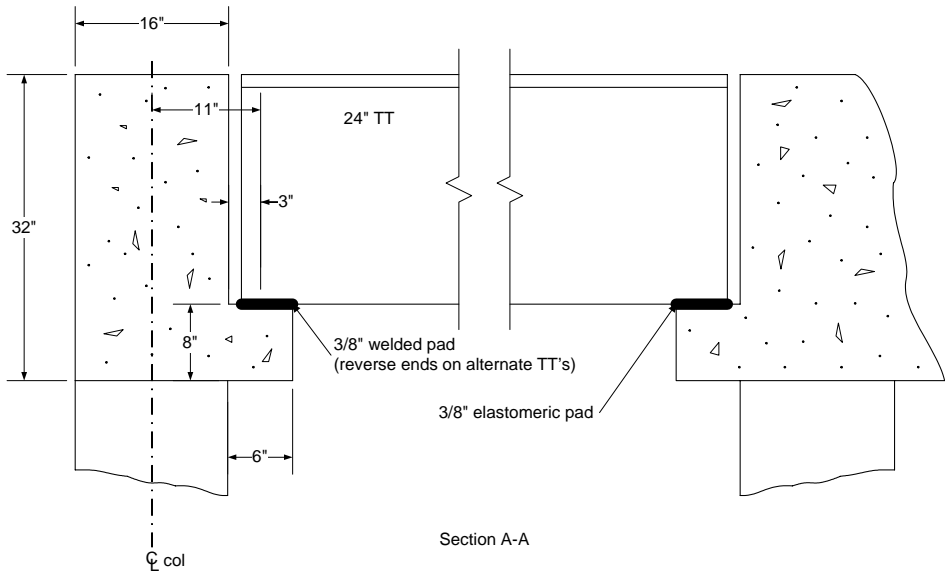

Program input

- From the **Input** menu, select **General Information**. A dialog box appears.
 - In the LABELS section, input the names of the project, frame, and engineer.
 - In the FRAME section, input 2 for NO OF SUPPORTS.
 - In the FLOOR SYSTEM section, click the radial button next to ONE WAY / BEAM.
 - Leave all other options in the **General Information** tab to their default settings of ACI 318-02 design code, ASTM A615 reinforcement, and DESIGN run mode option.
 - In the **Solve Options** tab, click the check box next to TORSION ANALYSIS AND DESIGN.
 - Under TORSION TYPE, click the radial button next to EQUILIBRIUM.
 - Under the heading STIRRUPS IN FLANGES, click the radial button next to YES.

- Press OK.

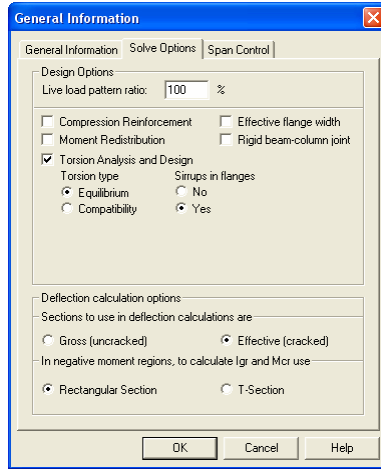
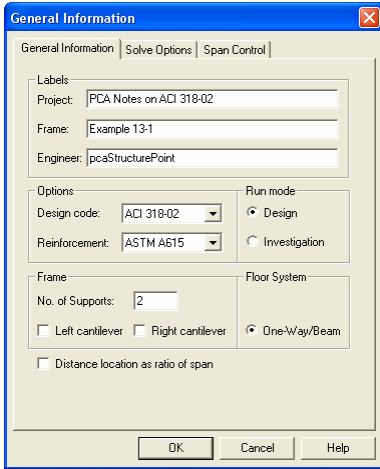

2. From the **Input** menu, select **Material Properties**. A dialog box appears.

- Input 5 for Comp. strength for both Slabs and Beams and Columns.
- Press OK.

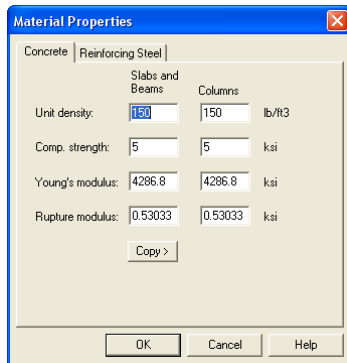

3. From the **Input** menu, select **Spans**. A dialog box appears.

- Under the **Slabs/Flanges** tab, input 30 for LENGTH, 8 for THICKNESS, and 0.667 for WIDTH LEFT and 1.167 WIDTH RIGHT. Press MODIFY.

- Select the **Longitudinal Beams** tab. Input 16 for WIDTH and 32 for DEPTH. Press MODIFY.
- Press OK.

Span No.	Location	Length	Thickness	Width-L	Width-R
1	Interior	30	8	0.667	1.167

Span No.	Width	Depth
1	16	32

4. From the **Input** menu, select **Supports**. A dialog box appears.
 - Under the **Columns** tab, input 0 for STIFFNESS SHARE %.

- Next, input 16 for both the c1 and c2 values in both the ABOVE and BELOW rows. Press MODIFY. (Note: the default HEIGHT ABOVE and HEIGHT BELOW values of 10 are correct.)
- Press COPY. Press the CHECK ALL button. Press OK.
- Press OK again.

Sup. No	Stiff%	H/A	c1A	c2A	H/B	c1B	c2B
1	0	10	16	16	10	16	16
2	0	10	16	16	10	16	16

5. From the **Input** menu, select **Reinforcement**. A dialog box appears.
 - Under the **Slabs and Ribs** tab, change the CLEAR COVER for both TOP and BOTTOM BARS to 1 . 75.
 - Under the **Beams** tab, change the CLEAR COVER for both TOP and BOTTOM BARS again to 1 . 75.
 - Use the drop down arrow for MINIMUM STIRRUP BAR SIZE to select #4.
 - Press OK.

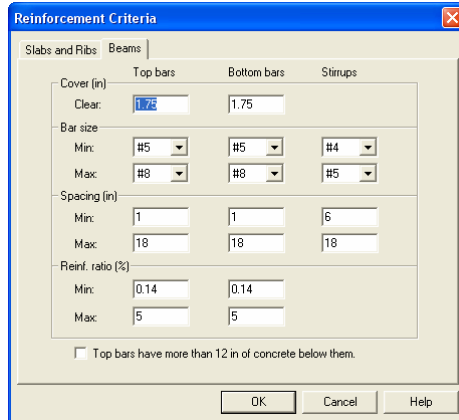
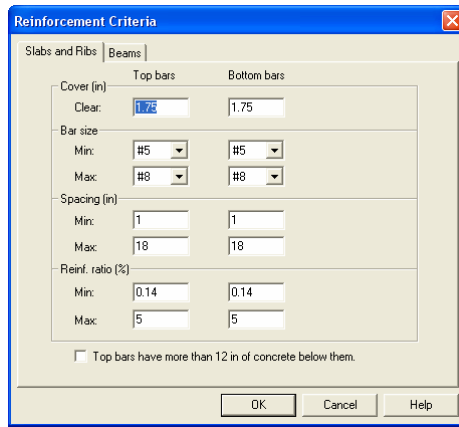

6. 6. From the **Input** menu, select **Load Cases**. A dialog box appears.
 - Since we are not considering lateral forces, click on WIND in the LABEL column on the list in the bottom half of the LOAD CASES dialog box and press the DELETE button.
 - Click on EQ in the LABEL column and press the DELETE button.
 - Press OK.

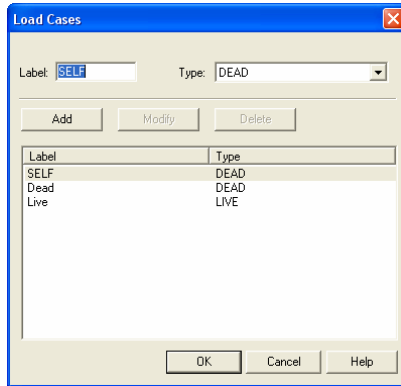

7. 7. From the **Input** menu, select **Load Combinations**. A dialog box appears.
 - Delete all the load combinations by clicking anywhere on the list in the bottom half of the LOAD COMBINATIONS dialog box and pressing the DELETE button. Repeat this procedure until all the load combinations are gone.
 - Input 0 in the SELF field, 1.2 in the DEAD field, and 1.6 in the LIVE field. Press ADD.
 - Press OK.

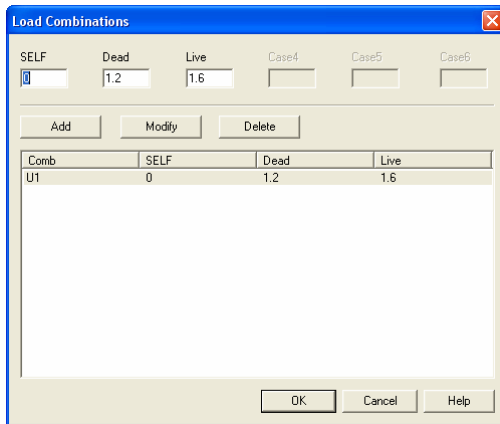

8. 8. From the **Input** menu, select **Span Loads**. A dialog box appears.
 - Press the drop down arrow next to TYPE, and select LINE LOAD.

- Input 2500 for both the START and END MAGNITUDE. (Note: this value was obtained by converting the area loads on the roof and the beam's self weight into line loads.)

Dead Load = Superimposed Load + Self Weight of Spandrel Beam =

$$\left(64\text{psf} \times \frac{60\text{ft}}{2}\right) + [(1.33\text{ft} \times 2.67\text{ft}) + (0.5\text{ft} \times 0.67\text{ft})] \times 150\text{pcf} = 2.5\text{kip} / \text{ft}$$

- Input 30 for the END LOCATION. Press ADD.
- Use the drop down arrow next to TYPE, and select LINE TORSION.
- Input 1.76 for both the START and END MAGNITUDE. (Note: this value was obtained by multiplying the superimposed line load by the moment arm of 11 in.)

$$\text{Torsion Line Load (Dead)} = \left(64\text{psf} \times \frac{60\text{ft}}{2}\right) \times \frac{11\text{in}}{12\text{in} / \text{ft}} = 1.76\text{kip} \cdot \text{ft} / \text{ft}$$

- Keep the END LOCATION of 30 and press ADD.

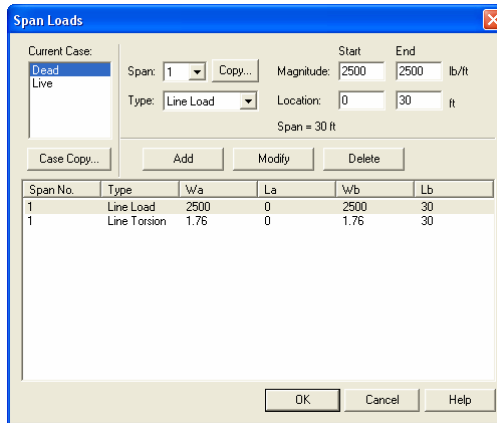

9. In the top left corner of the SPAN LOADS dialog box, there is a section called CURRENT CASE. Click on LIVE.
 - Use the drop down arrow next to TYPE to select LINE LOAD. I

- Input 900 for both the START and END MAGNITUDE. (Note: this value was obtained by converting the area loads on the roof to line loads on the beam.)

$$\text{Live Load} = 30\text{psf} \times \left(\frac{60\text{ft}}{2}\right) = 900\text{lb} / \text{ft}$$

- Input 30 for the END LOCATION. Press ADD.
- Use the drop down arrow next to TYPE, and select LINE TORSION.
- Input 0.825 for both the START and END MAGNITUDE. (Note: this value was obtained by multiplying the live line load by the moment arm of 11 in.)

$$\left[30\text{psf} \times \left(\frac{60\text{ft}}{2}\right) \right] \times \frac{1\text{ in}}{12\text{in} / \text{ft}} = 0.825\text{kip} \cdot \text{ft} / \text{ft}$$

- Input 30 for the END LOCATION. Press ADD.
- Press OK.

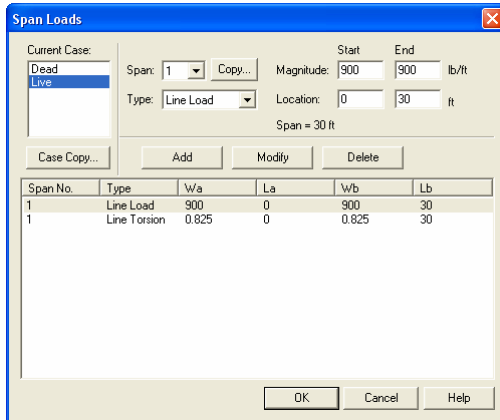

10. From the **Solve** menu, select **Execute**. Press CLOSE.
11. From the **Solve** menu, select **Results Report**.
 - Use the scroll bars to scroll through the results file.

- Use the ARROW keys or the mouse wheel to browse through different parts of the results quickly. Press the CLOSE button to close the RESULTS REPORT dialog box and return to pcaBeam.
12. To view diagrams, select **Loads, Internal Forces, Moment Capacity, Shear Capacity, Deflection, or Reinforcement** from the **View** menu. Right click in any of these diagrams to get new copy, printing, or display options.
 13. You may print the results file by selecting **Print Results** from the **File** menu. To print any of the diagrams you selected to view, use the **Print Preview** command found by right clicking in the diagram's window. After viewing the results, you may decide to investigate the input beams under the same loads but with a modified reinforcement configuration.
 14. From the **Input** menu, select **General Information**. In the **General Information** dialog box change the RUN MODE option to INVESTIGATION. Do not change any of the other options. Press OK
 15. From the **Input** menu, select the different commands under **Reinforcement Criteria** and **Reinforcing Bars** to modify the reinforcement configuration computed by the program.
 16. Repeat steps 10 and subsequent to perform the investigation and view the results.

Text Output

```

oooooooo      oooooo      ooooo
oooooooooooo  oooooooooo  oooooooooo
oo  oo  oo  oo  oo  oo  oo
oo  oo  oo  oo  oo  oo  oo
oooooooooooo  oo  oooooooo  oooooo
oooooooooooo  oo  oo  oooooooo  oooooo
oo  oo  oo  oo  oo  oo  oo
oo  oooooooooo  oo  oo
oo  ooooooo  oo  oo

```

```

00000  000000  00000  oo  oo
oo  oo  oo  oo  oo  oo  oo  oo
oo  oo  oo  oo  oo  oo  oo  o  oo
oo  oo  oo  oo  oo  oo  oo  o  oo
oooooooo  oooooo  oooooooooo  oo  o  oo
oo  oo  oo  oo  oo  oo  oo  oo
oo  oo  oo  oo  oo  oo  oo  oo
oo  oo  oo  oo  oo  oo  oo  oo
oooooooo  oooooo  oo  oo  oo  oo

```

```

=====
                          pcaBeam v1.50 (TM)
A Computer Program for Analysis, Design, and Investigation of
Reinforced Concrete Continuous Beam and One-Way Slab Systems
=====
Copyright © 1992-2005, Portland Cement Association
All rights reserved

```

Licensee stated above acknowledges that Portland Cement Association (PCA) is not and cannot be responsible for either the accuracy or adequacy of the material supplied as input for processing by the pcaBeam computer program. Furthermore, PCA neither makes any warranty expressed nor implied with respect to the correctness of the output prepared by the pcaBeam program. Although PCA has endeavored to produce pcaBeam error free the program is not and cannot be certified infallible. The final and only responsibility for analysis, design and engineering documents is the licensees. Accordingly, PCA disclaims all responsibility in contract, negligence or other tort for any analysis, design or engineering documents prepared in connection with the use of the pcaBeam program.

```

=====
[1] INPUT ECHO
=====

```

General Information:

```

=====
File name: C:\Data\pcaBeam\PCA Notes on ACI 318-02 Example 13-1.slb
Project: PCA Notes on ACI 318-02
Frame: Example 13-1
Code: ACI 318-02      Mode: Design
Number of supports = 2
Floor System: One-Way/Beam
Engineer: pcaStructurePoint
Reinforcement Database: ASTM A615

```

```

Live load pattern ratio = 100%
Deflections are based on cracked section properties.
In negative moment regions, Igr and Mcr DO NOT include flange/slab contribution (if available)
Compression reinforcement calculations NOT selected.
Moment redistribution NOT selected.
Effective flange width calculations NOT selected.
Rigid beam-column joint NOT selected.
Torsion analysis and design selected.
Stirrups in flanges (if available) selected.

```

Compatibility torsion NOT selected.

Material Properties:

```

=====
                Slabs|Beams          Columns
                -----
wc   =          150                150 lb/ft3
f'c  =           5                  5 ksi
Ec   =        4286.8              4286.8 ksi
fr   =        0.53033            0.53033 ksi

fy   =          60 ksi, Bars are not epoxy-coated
fyv  =          60 ksi
Es   =        29000 ksi
    
```

Reinforcement Database:

```

=====
Units: Db (in), Ab (in^2), Wb (lb/ft)
Size  Db      Ab      Wb      Size  Db      Ab      Wb
-----
#3    0.38    0.11    0.38    #4    0.50    0.20    0.67
#5    0.63    0.31    1.04    #6    0.75    0.44    1.50
#7    0.88    0.60    2.04    #8    1.00    0.79    2.67
#9    1.13    1.00    3.40    #10   1.27    1.27    4.30
#11   1.41    1.56    5.31    #14   1.69    2.25    7.65
#18   2.26    4.00    13.60
    
```

Span Data:

```

=====
Slabs: L1, wL, wR (ft); t, Hmin (in)
Span Loc      L1      t      wL      wR      Hmin
-----
1 Int         30.000  8.00  0.667  1.167  0.00
    
```

Ribs and Longitudinal Beams: b, h, Sp (in)

```

-----
Span  Ribs          Beams          Span
      b      h      Sp      b      h      Hmin
-----
1     0.00  0.00  0.00  16.00  32.00  22.50
    
```

Support Data:

```

=====
Columns: c1a, c2a, c1b, c2b (in); Ha, Hb (ft)
Supp   c1a  c2a  c1b  c2b  Ha  Hb  Red%
-----
1      16.00  16.00  10.000  16.00  16.00  10.000  0
2      16.00  16.00  10.000  16.00  16.00  10.000  0
    
```

Boundary Conditions: Kz (kip/in); Kry (kip-in/rad)

```

Supp   Spring Kz   Spring Kry   Far End A   Far End B
-----
1           0           0   Fixed     Fixed
2           0           0   Fixed     Fixed
    
```

Load Data:

```

=====
Load Cases and Combinations:
Case   SELF   Dead   Live
Type   DEAD   DEAD   LIVE
U1     0.000   1.200   1.600

Span Loads:
Span Case          Wa          La          Wb          Lb
-----
Line Loads - Wa | Wb (lb/ft), La | Lb (ft):
1 Dead           2500           0           2500           30
1 Live            900           0           900           30
Line Torsion - Wa | Wb (k-ft/ft), La | Lb (ft):
    
```

1 Dead 1.76 0 1.76 30
 1 Live 0.825 0 0.825 30

Support Loads: --- NONE ---

Support Displacements: --- NONE ---

Reinforcement Criteria:

```

=====
                Top bars      Bottom bars      Stirrups
                Min      Max      Min      Max      Min      Max
-----
Slabs and Ribs:
Bar Size      #5      #8      #5      #8
Bar spacing   1.00  18.00  1.00  18.00 in
Reinf ratio   0.14  5.00   0.14  5.00 %
Cover        1.50      1.50      in
=====
Beams:
Bar Size      #5      #8      #5      #8      #4      #5
Bar spacing   1.00  18.00  1.00  18.00  6.00  18.00 in
Reinf ratio   0.14  5.00   0.14  5.00 %
Cover        1.75      1.75      in
=====
    
```

[2] DESIGN RESULTS

Top Reinforcement:

```

=====
Units: Width (ft), Mmax (k-ft), Xmax (ft), As (in^2), Sp (in)
Span Zone      Width      Mmax      Xmax      AsMin      AsMax      SpReq      AsReq      Bars
-----
1 Left         1.83      0.00     0.667    0.671    10.179    8.990    0.000    3-#5
1 Middle       1.83      0.00    15.000    0.000    10.179    0.000    0.000    ---
1 Right        1.83      0.00    29.333    0.671    10.179    8.990    0.000    3-#5
    
```

Top Bar Details:

```

=====
Units: Length (ft)
Span      Left      Continuous      Right
Bars      Length      Bars      Length      Bars      Length      Bars      Length
-----
1      3-#5  10.13      ---      ---      3-#5  10.13      ---
    
```

Bottom Reinforcement:

```

=====
Units: Width (ft), Mmax (k-ft), Xmax (ft), As (in^2), Sp (in)
Span      Width      Mmax      Xmax      AsMin      AsMax      SpReq      AsReq      Bars
-----
1      1.33      499.50  15.000    1.686    13.541    1.966    3.882    7-#7
    
```

Bottom Bar Details:

```

=====
Units: Start (ft), Length (ft)
Span      Long Bars      Short Bars
Bars      Start      Length      Bars      Start      Length
-----
1      4-#7  0.00  30.00  3-#7  0.00  30.00
    
```

Flexural Capacity:

```

=====
Units: From, To (ft), As (in^2), PhiMn (k-ft)
Span      From      To      AsTop      AsBot      PhiMn-      PhiMn+
-----
1      0.000    0.667  0.93  4.20  -124.62  542.72
      0.667    9.127  0.93  4.20  -124.62  542.72
    
```

9.127	10.127	0.00	4.20	0.00	542.72
10.127	10.700	0.00	4.20	0.00	542.72
10.700	15.000	0.00	4.20	0.00	542.72
15.000	19.300	0.00	4.20	0.00	542.72
19.300	19.873	0.00	4.20	0.00	542.72
19.873	20.873	0.00	4.20	0.00	542.72
20.873	29.333	0.93	4.20	-124.62	542.72
29.333	30.000	0.93	4.20	-124.62	542.72

Longitudinal Beam Shear And Torsion Reinforcement Required:

=====

Section properties:

Units: d, pcp, pch (in), Acp, Ach, Ao (in^2)
 PhiVc (kip), PhiTcr (k-ft), PhiSvt (ksi)

Span	d	pcp	ph	Acp	Aoh	Ao	PhiVc	PhiTcr	PhiSvt
1	29.75	108.02	96.02	560.064	407.040	345.984	50.49	51.33	0.530

Required transverse reinforcement:

Units: Start, End, Xu (ft), Vu (kip), Tu (k-ft), vf (ksi)
 Av/s, Av/s, A(v+2t)/s (in^2/in)

Span	Start	End	Vu	Tu	vf	Xu	Case/Patt	Av/s	At/s	A(v+2t)/s
1	3.146	6.533	52.63	40.68	0.200	3.15	U1/All	0.0016	0.0157	0.0330
	6.533	9.920	37.59	29.06	0.143	6.53	U1/All	0.0000	0.0112	0.0224
*5	9.920	13.307	22.56	17.44	0.086	9.92	U1/All	0.0000	0.0067	0.0141
*5	13.307	16.693	7.52	5.81	0.029	13.31	U1/All	0.0000	0.0000	0.0000
*2	16.693	20.080	22.56	17.44	0.086	20.08	U1/All	0.0000	0.0067	0.0141
*5	20.080	23.467	37.59	29.06	0.143	23.47	U1/All	0.0000	0.0112	0.0224
*5	23.467	26.854	52.63	40.68	0.200	26.85	U1/All	0.0016	0.0157	0.0330

NOTES:

- *2 - Torsion ignored (Tu < PhiTcr/4).
- *5 - Minimum transverse (stirrup) reinforcement required.

Required longitudinal reinforcement:

Units: Start, End, Xu (ft), Tu (k-ft), Al (in^2)

Span	Start	End	Tu	Xu	Case/Patt	Al
1	3.146	6.533	29.06	6.53	U1/All	2.225 *5
	6.533	9.920	17.44	9.92	U1/All	2.655 *5
	9.920	13.307	16.73	10.13	U1/All	2.660 *5
	13.307	16.693	5.81	13.31	U1/All	0.000 *2
	16.693	20.080	13.77	19.01	U1/All	2.660 *5
	20.080	23.467	17.44	20.08	U1/All	2.655 *5
	23.467	26.854	29.06	23.47	U1/All	2.225 *5

NOTES:

- *2 - Torsion ignored (Tu < PhiTcr/4).
- *5 - Minimum longitudinal reinforcement required.

Longitudinal Beam Shear Reinforcement Details:

=====

Units: spacing & distance (in).
 Span Size Stirrups (2 legs each unless otherwise noted)

1	#4 14 @ 11.4 + <-- 40.6 --> + 14 @ 11.4
---	---

Longitudinal Torsional Reinforcement Details:

=====

Units: Start (ft), Length (ft)

Span	Long Bars			Short Bars		
	Bars	Start	Length	Bars	Start	Length
1	---			12-#5	0.00	12.27

--- 12-#5 17.73 12.27

Beam Shear And Torsion Capacity:

=====

Section properties:

Units: d, pcp, pch (in), Acp, Ach, Ao (in²)

PhiVc (kip), PhiTcr (k-ft), PhiSvt (ksi)

Span	d	pcp	ph	Acp	Aoh	Ao	PhiVc	PhiTcr	PhiSvt
1	29.75	108.02	96.02	560.064	407.040	345.984	50.49	51.33	0.530

Beam shear and torsion transverse reinforcement capacity in terms of provided and required area:

Units: Start, End, Xu (ft), Sp (in), A(v+2t)/s (in²/in)

Vu (kip), Tu (k-ft), vf (ksi)

Span	Provided		Required		Xu	Vu	Tu	Case/Patt	vf	
	Start	End	A(v+2t)	Sp A(v+2t)/s						
1	0.000	0.917	----	----	0.00	66.60	51.48	U1/All	0.25	
0.0517	0.917	11.273	0.400	11.44	0.0350	3.15	52.63	40.68	U1/All	0.20
0.0330 *5	11.273	13.307	0.400	11.44	0.0350	11.27	16.55	12.79	U1/All	0.06
0.0000 *2	13.307	16.693	----	----	----	13.31	7.52	5.81	U1/All	0.03
0.0000 *2	16.693	18.727	0.400	11.44	0.0350	18.73	16.55	12.79	U1/All	0.06
0.0000 *2	18.727	29.083	0.400	11.44	0.0350	26.85	52.63	40.68	U1/All	0.20
0.0330 *5	29.083	30.000	----	----	----	30.00	66.60	51.48	U1/All	0.25
0.0517										

NOTES:

*2 - Torsion ignored (Tu < PhiTcr/4).

*5 - Minimum transverse (stirrup) reinforcement required.

Beam torsion longitudinal reinforcement capacity in terms of provided and required area:

Units: Start, End, Xu (ft), Al (in²), Tu (kip)

Span	Provided		Required		Xu	Tu	Case/Patt	Al
	Start	End	Al	Xu				
1	0.000	0.917	----	0.00	51.48	U1/All	1.905	
	0.917	11.273	3.720	10.13	16.73	U1/All	2.660 *5	
	11.273	13.307	----	11.27	12.79	U1/All	0.000 *2	
	13.307	16.693	----	13.31	5.81	U1/All	0.000 *2	
	16.693	18.727	----	16.69	5.81	U1/All	0.000 *2	
	18.727	29.083	3.720	19.01	13.77	U1/All	2.660 *5	
	29.083	30.000	----	30.00	51.48	U1/All	1.905	

NOTES:

*2 - Torsion ignored (Tu < PhiTcr/4).

*5 - Minimum longitudinal reinforcement required.

Slab Shear Capacity:

=====

Units: b, d (in), Xu (ft), PhiVc, Vu(kip)

Span	b	d	Vratio	PhiVc	Vu	Xu
1	--- Not checked ---					

Maximum Deflections:

=====

Units: Dz (in)

Span Dz(DEAD) Dz(LIVE) Dz(TOTAL)

Span	Dz(DEAD)	Dz(LIVE)	Dz(TOTAL)
1	-0.496	-0.161	-0.658

Material Takeoff:

```

=====
Reinforcement in the Direction of Analysis
-----
Top Bars:      63.4 lb  <=>  2.11 lb/ft  <=>  1.152 lb/ft^2
Bottom Bars:   429.2 lb  <=>  14.31 lb/ft  <=>  7.802 lb/ft^2
Torsion Bars:  307.2 lb  <=>  10.24 lb/ft  <=>  5.584 lb/ft^2
Stirrups:      392.8 lb  <=>  13.09 lb/ft  <=>  7.139 lb/ft^2
Total Steel:   1192.6 lb  <=>  39.75 lb/ft  <=>  21.676 lb/ft^2
Concrete:      116.7 ft^3  <=>  3.89 ft^3/ft  <=>  2.121 ft^3/ft^2
  
```

[3] COLUMN AXIAL FORCES AND MOMENTS

```

Units: P (kip), M (k-ft)
-----
Supp Case/Patt   P (axial)   Mb[top]   Ma[bottom]
-----
1 SELF           8.75         0.00      0.00
  Dead           37.50         0.00      0.00
  Live/All       13.50         0.00      0.00
  Live/Odd       13.50         0.00      0.00
  Live/Even      0.00          0.00      0.00
  Live/S1        13.50         0.00      0.00
  Live/S2        13.50         0.00      0.00

2 SELF           8.75         0.00     -0.00
  Dead           37.50         0.00      0.00
  Live/All       13.50         0.00      0.00
  Live/Odd       13.50         0.00      0.00
  Live/Even      0.00          0.00      0.00
  Live/S1        13.50         0.00      0.00
  Live/S2        13.50         0.00      0.00

Sum SELF         17.50         0.00     -0.00
  Dead           75.00         0.00      0.00
  Live/All       27.00         0.00      0.00
  Live/Odd       27.00         0.00      0.00
  Live/Even      0.00          0.00      0.00
  Live/S1        27.00         0.00      0.00
  Live/S2        27.00         0.00      0.00
  
```

[6] SEGMENTAL MOMENT AND SHEAR - ENVELOPES

Span	x (ft)	M- (k-ft) Comb	M+ (k-ft) Comb	V- (kip) Comb	V+ (kip) Comb
1	0.000	0.00 U1	0.00 U1	0.00 U1	66.60 U1
	0.222	0.00 U1	14.69 U1	0.00 U1	65.61 U1
	0.444	0.00 U1	29.16 U1	0.00 U1	64.63 U1
	0.667	0.00 U1	43.41 U1	0.00 U1	63.64 U1
	0.667	0.00 U1	43.41 U1	0.00 U1	63.64 U1
	0.953	0.00 U1	61.47 U1	0.00 U1	62.37 U1
	1.240	0.00 U1	79.17 U1	0.00 U1	61.09 U1
	1.527	0.00 U1	96.50 U1	0.00 U1	59.82 U1
	1.813	0.00 U1	113.47 U1	0.00 U1	58.55 U1
	2.100	0.00 U1	130.07 U1	0.00 U1	57.28 U1
	2.387	0.00 U1	146.31 U1	0.00 U1	56.00 U1
	2.673	0.00 U1	162.18 U1	0.00 U1	54.73 U1
	2.960	0.00 U1	177.69 U1	0.00 U1	53.46 U1
	3.247	0.00 U1	192.83 U1	0.00 U1	52.18 U1
	3.533	0.00 U1	207.60 U1	0.00 U1	50.91 U1
	3.820	0.00 U1	222.02 U1	0.00 U1	49.64 U1
	4.107	0.00 U1	236.06 U1	0.00 U1	48.37 U1

4.393	0.00	U1	249.75	U1	0.00	U1	47.09	U1
4.680	0.00	U1	263.06	U1	0.00	U1	45.82	U1
4.967	0.00	U1	276.02	U1	0.00	U1	44.55	U1
5.253	0.00	U1	288.61	U1	0.00	U1	43.28	U1
5.540	0.00	U1	300.83	U1	0.00	U1	42.00	U1
5.827	0.00	U1	312.69	U1	0.00	U1	40.73	U1
6.113	0.00	U1	324.18	U1	0.00	U1	39.46	U1
6.400	0.00	U1	335.31	U1	0.00	U1	38.18	U1
6.687	0.00	U1	346.07	U1	0.00	U1	36.91	U1
6.973	0.00	U1	356.47	U1	0.00	U1	35.64	U1
7.260	0.00	U1	366.50	U1	0.00	U1	34.37	U1
7.547	0.00	U1	376.17	U1	0.00	U1	33.09	U1
7.833	0.00	U1	385.48	U1	0.00	U1	31.82	U1
8.120	0.00	U1	394.42	U1	0.00	U1	30.55	U1
8.407	0.00	U1	402.99	U1	0.00	U1	29.27	U1
8.693	0.00	U1	411.20	U1	0.00	U1	28.00	U1
8.980	0.00	U1	419.05	U1	0.00	U1	26.73	U1
9.267	0.00	U1	426.53	U1	0.00	U1	25.46	U1
9.553	0.00	U1	433.64	U1	0.00	U1	24.18	U1
9.840	0.00	U1	440.39	U1	0.00	U1	22.91	U1
10.127	0.00	U1	446.78	U1	0.00	U1	21.64	U1
10.413	0.00	U1	452.80	U1	0.00	U1	20.36	U1
10.700	0.00	U1	458.45	U1	0.00	U1	19.09	U1
10.987	0.00	U1	463.74	U1	0.00	U1	17.82	U1
11.273	0.00	U1	468.67	U1	0.00	U1	16.55	U1
11.560	0.00	U1	473.23	U1	0.00	U1	15.27	U1
11.847	0.00	U1	477.43	U1	0.00	U1	14.00	U1
12.133	0.00	U1	481.26	U1	0.00	U1	12.73	U1
12.420	0.00	U1	484.72	U1	0.00	U1	11.46	U1
12.707	0.00	U1	487.82	U1	0.00	U1	10.18	U1
12.993	0.00	U1	490.56	U1	0.00	U1	8.91	U1
13.280	0.00	U1	492.93	U1	0.00	U1	7.64	U1
13.567	0.00	U1	494.94	U1	0.00	U1	6.36	U1
13.853	0.00	U1	496.58	U1	0.00	U1	5.09	U1
14.140	0.00	U1	497.86	U1	0.00	U1	3.82	U1
14.427	0.00	U1	498.77	U1	0.00	U1	2.55	U1
14.713	0.00	U1	499.32	U1	0.00	U1	1.27	U1
15.000	0.00	U1	499.50	U1	0.00	U1	0.00	U1
15.287	0.00	U1	499.32	U1	-1.27	U1	0.00	U1
15.573	0.00	U1	498.77	U1	-2.55	U1	0.00	U1
15.860	0.00	U1	497.86	U1	-3.82	U1	0.00	U1
16.147	0.00	U1	496.58	U1	-5.09	U1	0.00	U1
16.433	0.00	U1	494.94	U1	-6.36	U1	0.00	U1
16.720	0.00	U1	492.93	U1	-7.64	U1	0.00	U1
17.007	0.00	U1	490.56	U1	-8.91	U1	0.00	U1
17.293	0.00	U1	487.82	U1	-10.18	U1	0.00	U1
17.580	0.00	U1	484.72	U1	-11.46	U1	0.00	U1
17.867	0.00	U1	481.26	U1	-12.73	U1	0.00	U1
18.153	0.00	U1	477.43	U1	-14.00	U1	0.00	U1
18.440	0.00	U1	473.23	U1	-15.27	U1	0.00	U1
18.727	0.00	U1	468.67	U1	-16.55	U1	0.00	U1
19.013	0.00	U1	463.74	U1	-17.82	U1	0.00	U1
19.300	0.00	U1	458.45	U1	-19.09	U1	0.00	U1
19.587	0.00	U1	452.80	U1	-20.36	U1	0.00	U1
19.873	0.00	U1	446.78	U1	-21.64	U1	0.00	U1
20.160	0.00	U1	440.39	U1	-22.91	U1	0.00	U1
20.447	0.00	U1	433.64	U1	-24.18	U1	0.00	U1
20.733	0.00	U1	426.53	U1	-25.46	U1	0.00	U1
21.020	0.00	U1	419.05	U1	-26.73	U1	0.00	U1
21.307	0.00	U1	411.20	U1	-28.00	U1	0.00	U1
21.593	0.00	U1	402.99	U1	-29.27	U1	0.00	U1
21.880	0.00	U1	394.42	U1	-30.55	U1	0.00	U1
22.167	0.00	U1	385.48	U1	-31.82	U1	0.00	U1
22.453	0.00	U1	376.18	U1	-33.09	U1	0.00	U1
22.740	0.00	U1	366.51	U1	-34.37	U1	0.00	U1
23.027	0.00	U1	356.47	U1	-35.64	U1	0.00	U1
23.313	0.00	U1	346.07	U1	-36.91	U1	0.00	U1
23.600	0.00	U1	335.31	U1	-38.18	U1	0.00	U1

23.887	0.00 U1	324.18 U1	-39.46 U1	0.00 U1
24.173	0.00 U1	312.69 U1	-40.73 U1	0.00 U1
24.460	0.00 U1	300.83 U1	-42.00 U1	0.00 U1
24.747	0.00 U1	288.61 U1	-43.28 U1	0.00 U1
25.033	0.00 U1	276.02 U1	-44.55 U1	0.00 U1
25.320	0.00 U1	263.07 U1	-45.82 U1	0.00 U1
25.607	0.00 U1	249.75 U1	-47.09 U1	0.00 U1
25.893	0.00 U1	236.07 U1	-48.37 U1	0.00 U1
26.180	0.00 U1	222.02 U1	-49.64 U1	0.00 U1
26.467	0.00 U1	207.61 U1	-50.91 U1	0.00 U1
26.753	0.00 U1	192.83 U1	-52.18 U1	0.00 U1
27.040	0.00 U1	177.69 U1	-53.46 U1	0.00 U1
27.327	0.00 U1	162.18 U1	-54.73 U1	0.00 U1
27.613	0.00 U1	146.31 U1	-56.00 U1	0.00 U1
27.900	0.00 U1	130.07 U1	-57.28 U1	0.00 U1
28.187	0.00 U1	113.47 U1	-58.55 U1	0.00 U1
28.473	0.00 U1	96.50 U1	-59.82 U1	0.00 U1
28.760	0.00 U1	79.17 U1	-61.09 U1	0.00 U1
29.047	0.00 U1	61.48 U1	-62.37 U1	0.00 U1
29.333	0.00 U1	43.42 U1	-63.64 U1	0.00 U1
29.333	0.00 U1	43.42 U1	-63.64 U1	0.00 U1
29.556	0.00 U1	29.16 U1	-64.63 U1	0.00 U1
29.778	0.00 U1	14.69 U1	-65.61 U1	0.00 U1
30.000	-0.00 U1	0.00 U1	-66.60 U1	0.00 U1

=====
 [6b] SEGMENTAL TORSION - ENVELOPES
 =====

Span	x (ft)	T+ (k-ft)	Comb	T- (k-ft)	Comb
1	0.000	51.48 U1		0.00 U1	
	0.222	50.72 U1		0.00 U1	
	0.444	49.95 U1		0.00 U1	
	0.667	49.19 U1		0.00 U1	
	0.667	49.19 U1		0.00 U1	
	0.953	48.21 U1		0.00 U1	
	1.240	47.22 U1		0.00 U1	
	1.527	46.24 U1		0.00 U1	
	1.813	45.26 U1		0.00 U1	
	2.100	44.27 U1		0.00 U1	
	2.387	43.29 U1		0.00 U1	
	2.673	42.31 U1		0.00 U1	
	2.960	41.32 U1		0.00 U1	
	3.247	40.34 U1		0.00 U1	
	3.533	39.35 U1		0.00 U1	
	3.820	38.37 U1		0.00 U1	
	4.107	37.39 U1		0.00 U1	
	4.393	36.40 U1		0.00 U1	
	4.680	35.42 U1		0.00 U1	
	4.967	34.43 U1		0.00 U1	
	5.253	33.45 U1		0.00 U1	
	5.540	32.47 U1		0.00 U1	
	5.827	31.48 U1		0.00 U1	
	6.113	30.50 U1		0.00 U1	
	6.400	29.52 U1		0.00 U1	
	6.687	28.53 U1		0.00 U1	
	6.973	27.55 U1		0.00 U1	
	7.260	26.56 U1		0.00 U1	
	7.547	25.58 U1		0.00 U1	
	7.833	24.60 U1		0.00 U1	
	8.120	23.61 U1		0.00 U1	
	8.407	22.63 U1		0.00 U1	
	8.693	21.64 U1		0.00 U1	
	8.980	20.66 U1		0.00 U1	
	9.267	19.68 U1		0.00 U1	

9.553	18.69 U1	0.00 U1
9.840	17.71 U1	0.00 U1
10.127	16.73 U1	0.00 U1
10.413	15.74 U1	0.00 U1
10.700	14.76 U1	0.00 U1
10.987	13.77 U1	0.00 U1
11.273	12.79 U1	0.00 U1
11.560	11.81 U1	0.00 U1
11.847	10.82 U1	0.00 U1
12.133	9.84 U1	0.00 U1
12.420	8.85 U1	0.00 U1
12.707	7.87 U1	0.00 U1
12.993	6.89 U1	0.00 U1
13.280	5.90 U1	0.00 U1
13.567	4.92 U1	0.00 U1
13.853	3.94 U1	0.00 U1
14.140	2.95 U1	0.00 U1
14.427	1.97 U1	0.00 U1
14.713	0.98 U1	0.00 U1
15.000	0.00 U1	-0.00 U1
15.287	0.00 U1	-0.98 U1
15.573	0.00 U1	-1.97 U1
15.860	0.00 U1	-2.95 U1
16.147	0.00 U1	-3.94 U1
16.433	0.00 U1	-4.92 U1
16.720	0.00 U1	-5.90 U1
17.007	0.00 U1	-6.89 U1
17.293	0.00 U1	-7.87 U1
17.580	0.00 U1	-8.85 U1
17.867	0.00 U1	-9.84 U1
18.153	0.00 U1	-10.82 U1
18.440	0.00 U1	-11.81 U1
18.727	0.00 U1	-12.79 U1
19.013	0.00 U1	-13.77 U1
19.300	0.00 U1	-14.76 U1
19.587	0.00 U1	-15.74 U1
19.873	0.00 U1	-16.73 U1
20.160	0.00 U1	-17.71 U1
20.447	0.00 U1	-18.69 U1
20.733	0.00 U1	-19.68 U1
21.020	0.00 U1	-20.66 U1
21.307	0.00 U1	-21.64 U1
21.593	0.00 U1	-22.63 U1
21.880	0.00 U1	-23.61 U1
22.167	0.00 U1	-24.60 U1
22.453	0.00 U1	-25.58 U1
22.740	0.00 U1	-26.56 U1
23.027	0.00 U1	-27.55 U1
23.313	0.00 U1	-28.53 U1
23.600	0.00 U1	-29.52 U1
23.887	0.00 U1	-30.50 U1
24.173	0.00 U1	-31.48 U1
24.460	0.00 U1	-32.47 U1
24.747	0.00 U1	-33.45 U1
25.033	0.00 U1	-34.43 U1
25.320	0.00 U1	-35.42 U1
25.607	0.00 U1	-36.40 U1
25.893	0.00 U1	-37.39 U1
26.180	0.00 U1	-38.37 U1
26.467	0.00 U1	-39.35 U1
26.753	0.00 U1	-40.34 U1
27.040	0.00 U1	-41.32 U1
27.327	0.00 U1	-42.31 U1
27.613	0.00 U1	-43.29 U1
27.900	0.00 U1	-44.27 U1
28.187	0.00 U1	-45.26 U1
28.473	0.00 U1	-46.24 U1
28.760	0.00 U1	-47.22 U1

29.047	0.00 U1	-48.21 U1
29.333	0.00 U1	-49.19 U1
29.333	0.00 U1	-49.19 U1
29.556	0.00 U1	-49.95 U1
29.778	0.00 U1	-50.72 U1
30.000	0.00 U1	-51.48 U1

=====
 [7] SEGMENTAL DEFLECTIONS
 =====

Units: x (ft), Dz (in)

Span	x	Dz (DEAD)	Dz (LIVE)	Dz (TOTAL)
1	0.000	-0.000	-0.000	-0.000
	0.222	-0.012	-0.004	-0.016
	0.444	-0.023	-0.008	-0.031
	0.667	-0.035	-0.011	-0.047
	0.667	-0.035	-0.011	-0.047
	0.953	-0.050	-0.016	-0.067
	1.240	-0.065	-0.021	-0.087
	1.527	-0.080	-0.026	-0.107
	1.813	-0.095	-0.031	-0.126
	2.100	-0.110	-0.036	-0.146
	2.387	-0.125	-0.041	-0.165
	2.673	-0.139	-0.045	-0.185
	2.960	-0.154	-0.050	-0.204
	3.247	-0.168	-0.055	-0.223
	3.533	-0.182	-0.059	-0.241
	3.820	-0.196	-0.064	-0.260
	4.107	-0.210	-0.068	-0.278
	4.393	-0.223	-0.073	-0.296
	4.680	-0.237	-0.077	-0.314
	4.967	-0.250	-0.081	-0.331
	5.253	-0.263	-0.085	-0.348
	5.540	-0.275	-0.089	-0.365
	5.827	-0.287	-0.093	-0.381
	6.113	-0.300	-0.097	-0.397
	6.400	-0.311	-0.101	-0.412
	6.687	-0.323	-0.105	-0.428
	6.973	-0.334	-0.109	-0.442
	7.260	-0.345	-0.112	-0.457
	7.547	-0.355	-0.115	-0.471
	7.833	-0.366	-0.119	-0.484
	8.120	-0.375	-0.122	-0.497
	8.407	-0.385	-0.125	-0.510
	8.693	-0.394	-0.128	-0.522
	8.980	-0.403	-0.131	-0.534
	9.267	-0.411	-0.134	-0.545
	9.553	-0.420	-0.136	-0.556
	9.840	-0.427	-0.139	-0.566
	10.127	-0.435	-0.141	-0.576
	10.413	-0.442	-0.143	-0.585
	10.700	-0.448	-0.146	-0.594
	10.987	-0.454	-0.148	-0.602
	11.273	-0.460	-0.149	-0.609
	11.560	-0.465	-0.151	-0.617
	11.847	-0.470	-0.153	-0.623
	12.133	-0.475	-0.154	-0.629
	12.420	-0.479	-0.156	-0.634
	12.707	-0.482	-0.157	-0.639
	12.993	-0.486	-0.158	-0.644
	13.280	-0.489	-0.159	-0.647
	13.567	-0.491	-0.160	-0.650
	13.853	-0.493	-0.160	-0.653
	14.140	-0.494	-0.161	-0.655
	14.427	-0.495	-0.161	-0.657

14.713	-0.496	-0.161	-0.657
15.000	-0.496	-0.161	-0.658
15.287	-0.496	-0.161	-0.657
15.573	-0.495	-0.161	-0.657
15.860	-0.494	-0.161	-0.655
16.147	-0.493	-0.160	-0.653
16.433	-0.491	-0.160	-0.650
16.720	-0.489	-0.159	-0.647
17.007	-0.486	-0.158	-0.644
17.293	-0.482	-0.157	-0.639
17.580	-0.479	-0.156	-0.634
17.867	-0.475	-0.154	-0.629
18.153	-0.470	-0.153	-0.623
18.440	-0.465	-0.151	-0.617
18.727	-0.460	-0.149	-0.609
19.013	-0.454	-0.148	-0.602
19.300	-0.448	-0.146	-0.594
19.587	-0.442	-0.143	-0.585
19.873	-0.435	-0.141	-0.576
20.160	-0.427	-0.139	-0.566
20.447	-0.420	-0.136	-0.556
20.733	-0.411	-0.134	-0.545
21.020	-0.403	-0.131	-0.534
21.307	-0.394	-0.128	-0.522
21.593	-0.385	-0.125	-0.510
21.880	-0.375	-0.122	-0.497
22.167	-0.366	-0.119	-0.484
22.453	-0.355	-0.115	-0.471
22.740	-0.345	-0.112	-0.457
23.027	-0.334	-0.109	-0.442
23.313	-0.323	-0.105	-0.428
23.600	-0.311	-0.101	-0.412
23.887	-0.300	-0.097	-0.397
24.173	-0.287	-0.093	-0.381
24.460	-0.275	-0.089	-0.365
24.747	-0.263	-0.085	-0.348
25.033	-0.250	-0.081	-0.331
25.320	-0.237	-0.077	-0.314
25.607	-0.223	-0.073	-0.296
25.893	-0.210	-0.068	-0.278
26.180	-0.196	-0.064	-0.260
26.467	-0.182	-0.059	-0.241
26.753	-0.168	-0.055	-0.223
27.040	-0.154	-0.050	-0.204
27.327	-0.139	-0.045	-0.185
27.613	-0.125	-0.041	-0.165
27.900	-0.110	-0.036	-0.146
28.187	-0.095	-0.031	-0.126
28.473	-0.080	-0.026	-0.107
28.760	-0.065	-0.021	-0.087
29.047	-0.050	-0.016	-0.067
29.333	-0.035	-0.011	-0.047
29.333	-0.035	-0.011	-0.047
29.556	-0.023	-0.008	-0.031
29.778	-0.012	-0.004	-0.016
30.000	-0.000	-0.000	-0.000

Graphical Output

Loads

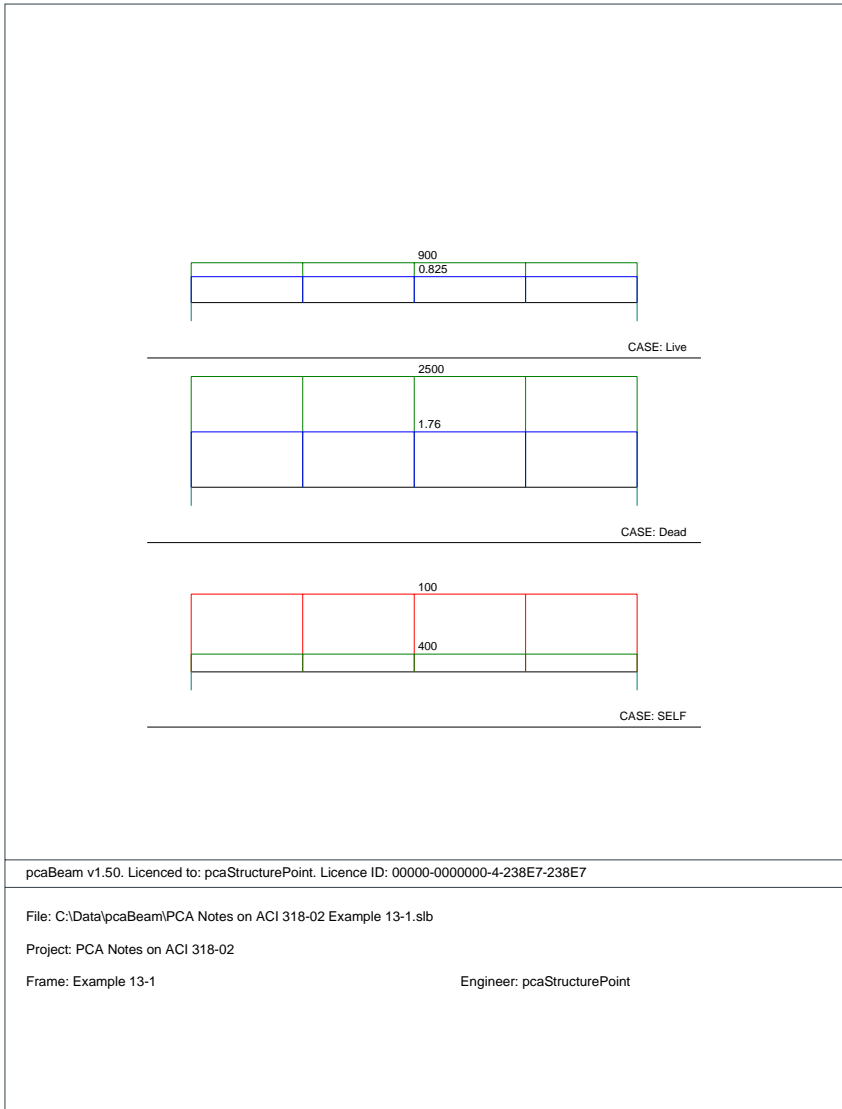

Internal Forces

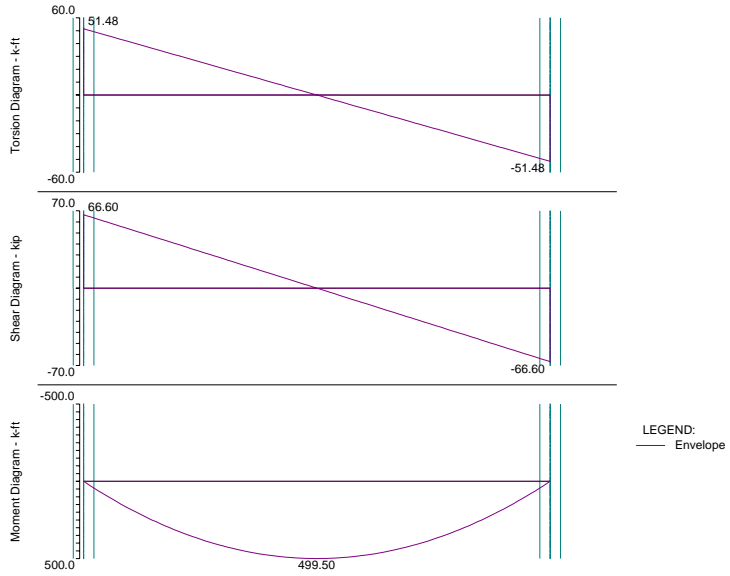

pcaBeam v1.50. Licenced to: pcaStructurePoint. Licence ID: 00000-0000000-4-238E7-238E7

File: C:\Data\pcaBeam\PCA Notes on ACI 318-02 Example 13-1.slb

Project: PCA Notes on ACI 318-02

Frame: Example 13-1

Engineer: pcaStructurePoint

Moment Capacity

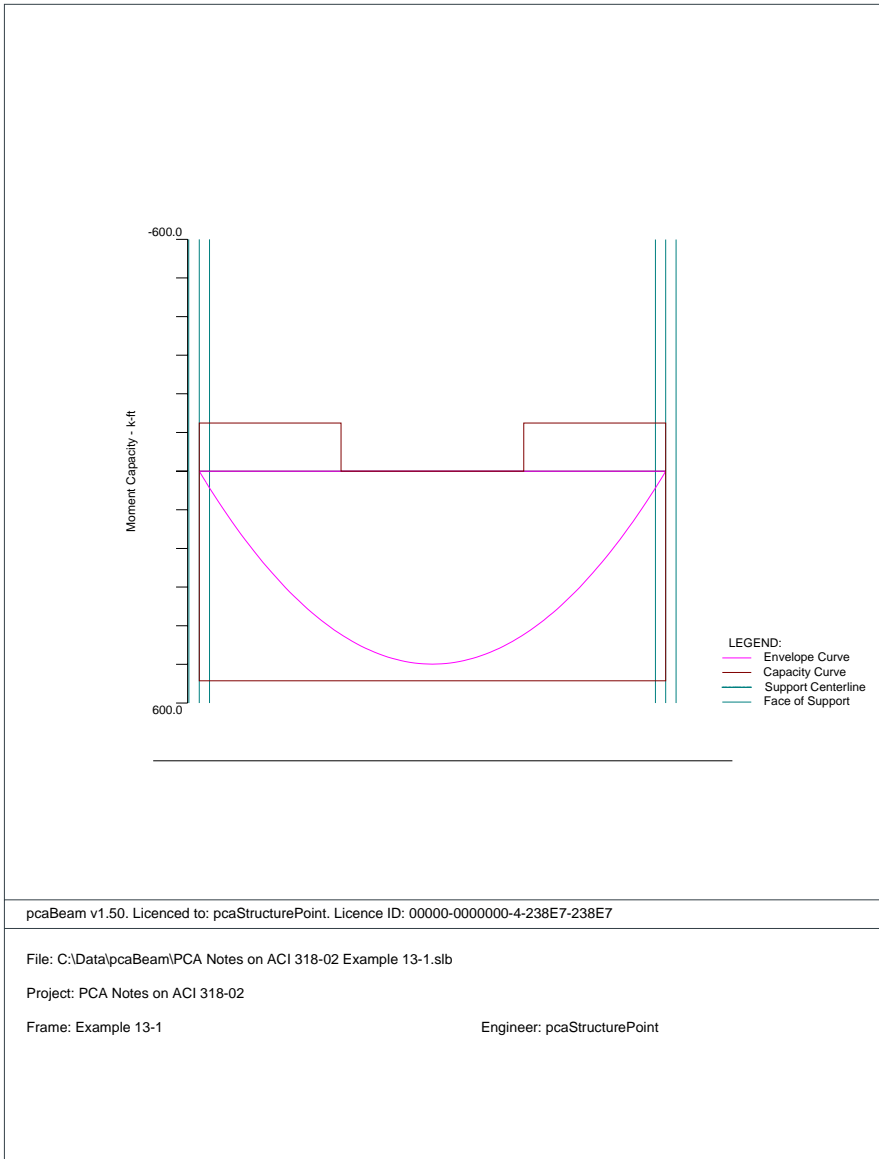

Shear Capacity

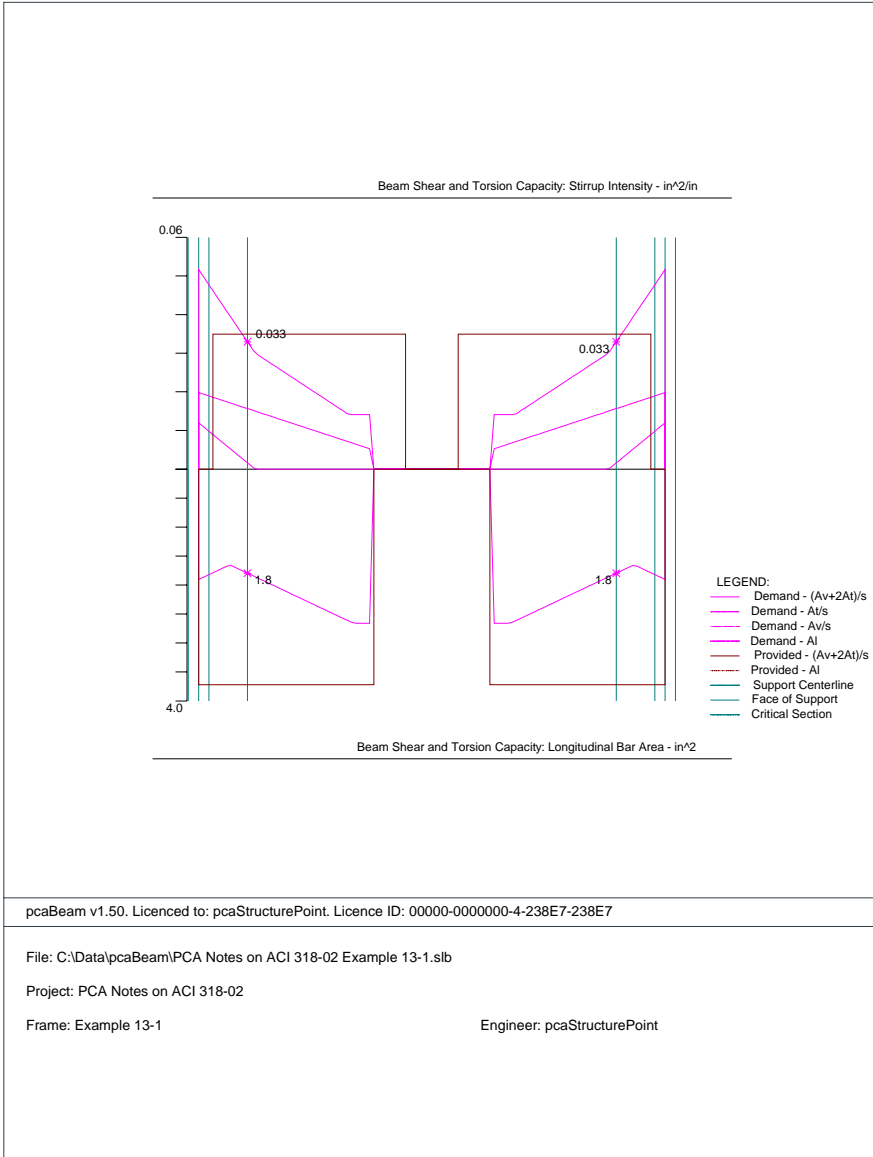

Deflection

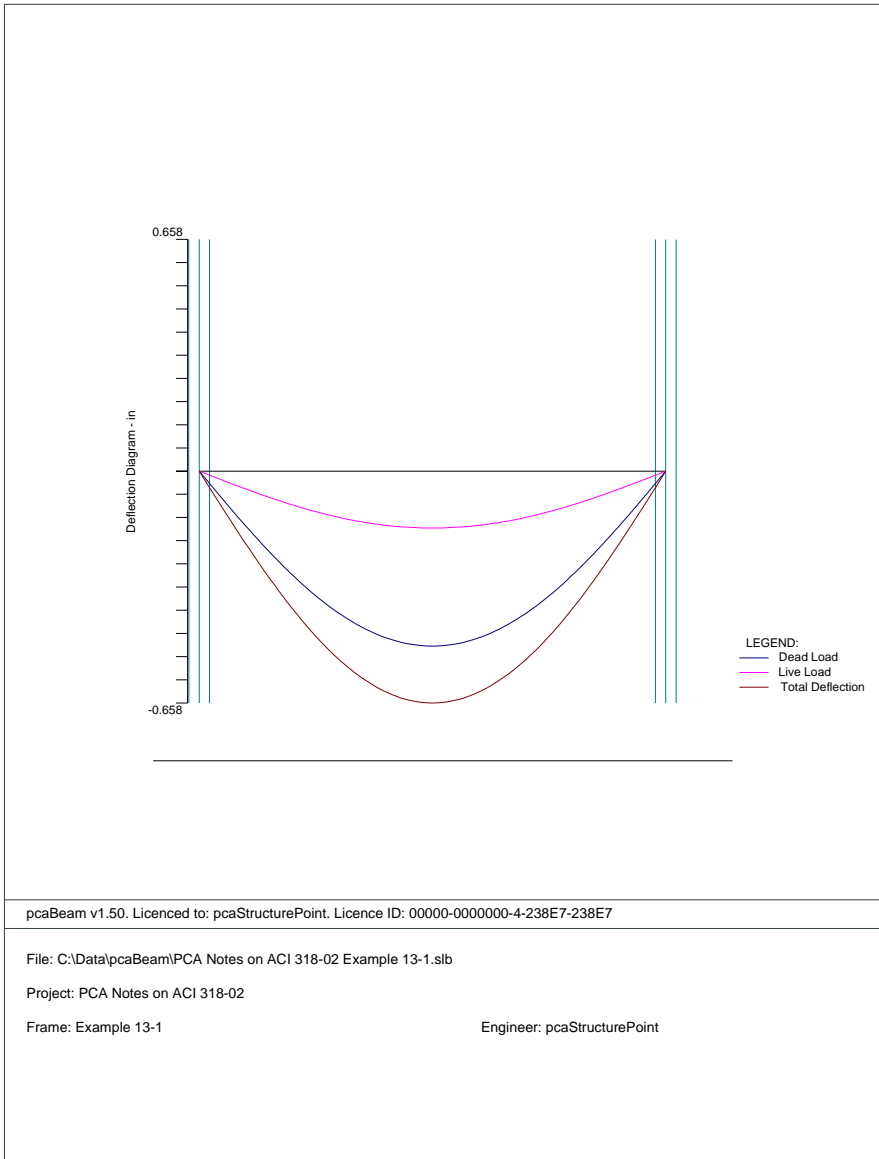

Reinforcement

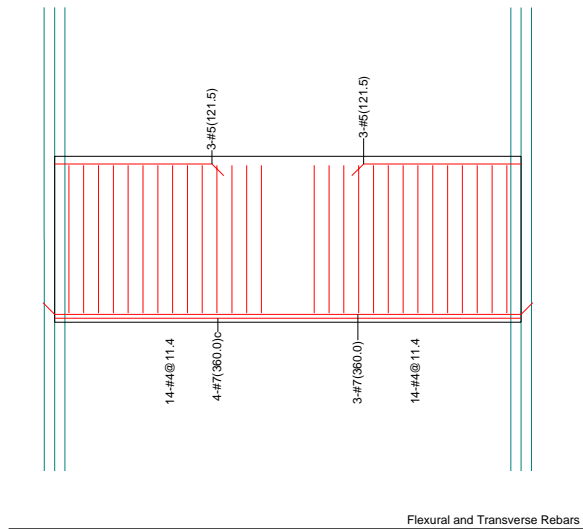

pcABeam v1.50. Licenced to: pcaStructurePoint. Licence ID: 00000-0000000-4-238E7-238E7

File: C:\Data\pcABeam\PCA Notes on ACI 318-02 Example 13-1.slb

Project: PCA Notes on ACI 318-02

Frame: Example 13-1

Engineer: pcaStructurePoint

Example 3 One-way slab system

Problem description

The system shown in the following figure consists of five spans symmetric about the centerline. We will be designing beam ABCD assuming that the other half of the beam will be loaded and designed the same way. All beams have a width of 12 in. and a depth of 22 in. – including the 5 in. thick deck. Span length and widths are shown in the figure. Columns have a 12 in. × 12 in. cross-section and a length equal to a typical story height of 13 ft. The system will be analyzed and designed under a uniform live load of 130 psf and a dead load that consists of the slab system's own weight plus 80 psf. Use $f'_c = 4$ ksi, $f_y = 60$ ksi, and $\gamma_{concrete} = 150$ pcf. This example refers to example 16.1 from *Structural Concrete: Theory and Design* by Hassoun and Al-Manaseer, Third Edition, 2005.

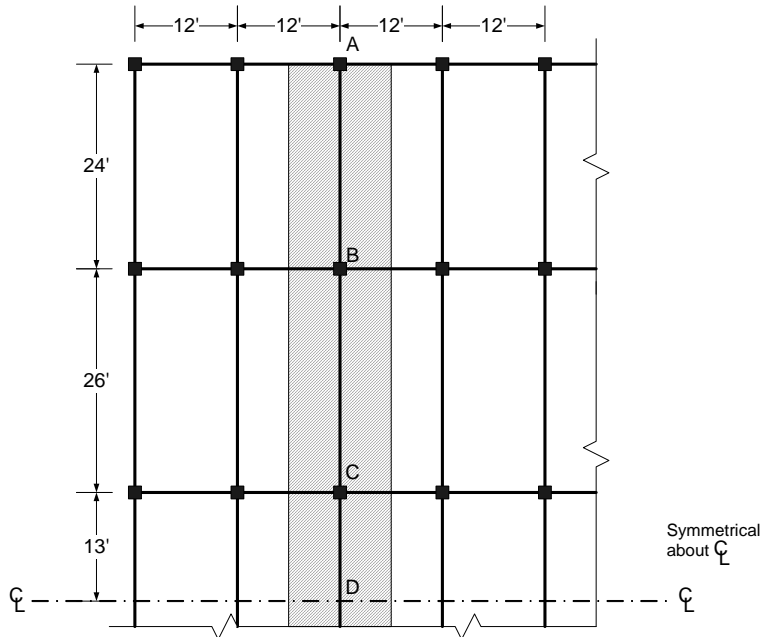

Program Input

1. From the **Input** menu, select **General Information**. A dialog box appears.

- In the LABELS section, input the names of the project, frame, and engineer.
- In the FRAME section, input 6 for NO OF SUPPORTS.
- In the FLOOR SYSTEM section, click the radial button next to ONE-WAY / BEAM.
- Leave all other options in the **General Information** tab to their default settings of ACI 318-02 design code, ASTM A615 reinforcement, and DESIGN run mode option.
- In the **Solve Options** tab, keep the default settings. Press OK.

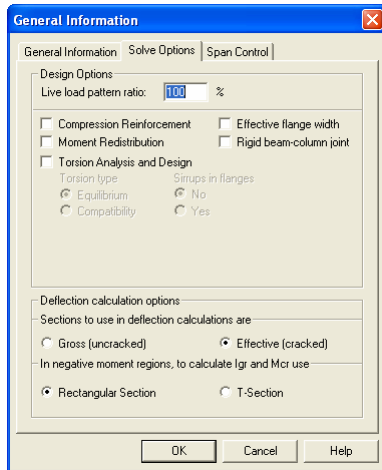
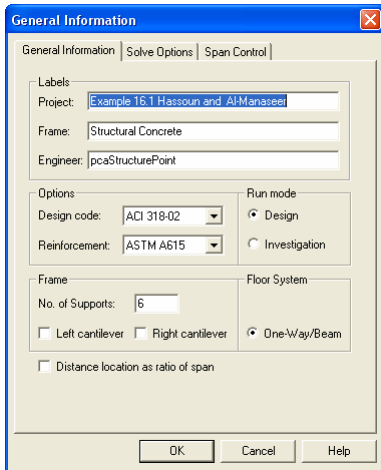

2. Nothing needs to be changed in the **Material Properties** menu.

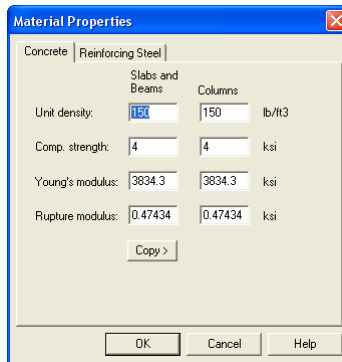

3. From the **Input** menu, select **Spans**. A dialog box appears.
 - Under the **Slabs/Flanges** tab, input 24 for LENGTH, 5 for THICKNESS, and 0 for WIDTH LEFT and WIDTH RIGHT. Press MODIFY. (Note: Since the slab has no width, we must convert the area loads to line loads along the beam and also add the self-weight of the slab to the dead load. This calculation will be shown in Step 8.)
 - Press COPY. Select the check box next to Span 5. Press OK. This will give Span 5 the same geometry as Span 1.
 - Press the drop down arrow next to SPAN and select Span 2. Input 26 for LENGTH, 5 for THICKNESS, and 0 for WIDTH LEFT and WIDTH RIGHT. Press MODIFY.
 - Press COPY. Unselect the check box next to Span 1 and select the check boxes next to Spans 3 and 4. Press OK.
 - Select the **Longitudinal Beams** tab. Input 12 for WIDTH and 22 for DEPTH. Press MODIFY.
 - Press COPY. Press the CHECK ALL button. Press OK.
 - Press OK again.

Span Data

Slabs/Flanges | Longitudinal Beams | Ribs

Span: 1 Length: 24 ft Width Left: 0 ft
 Location: Interior Thickness: 5 in Width Right: 0 ft

Modify Copy...

Span No.	Location	Length	Thickness	Width-L	Width-R
1	Interior	24	5	0	0
2	Interior	26	5	0	0
3	Interior	26	5	0	0
4	Interior	26	5	0	0
5	Interior	24	5	0	0

OK Cancel Help

Span Data

Slabs/Flanges | Longitudinal Beams | Ribs

Span: 1 Width: 12 in
 Depth: 22 in

Modify Copy...

Span No.	Width	Depth
1	12	22
2	12	22
3	12	22
4	12	22
5	12	22

OK Cancel Help

4. From the **Input** menu, select **Supports**. A dialog box appears.
 - Under the **Columns** tab, input 13 for both HEIGHT ABOVE and HEIGHT BELOW. Press MODIFY. (Note: the default C1 and C2 values for both the column above and below the support can be left alone since all the columns' cross sections are 12 in. × 12 in.)
 - Press COPY. Press the CHECK ALL button. Press OK.
 - Press OK again.

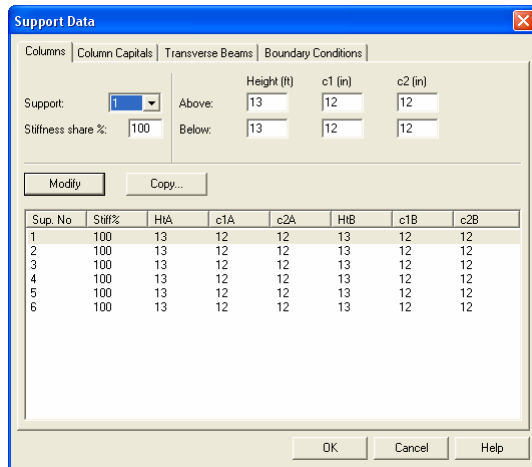

5. From the **Input** menu, select **Reinforcement Criteria**. A dialog box appears.
 - Under the **Beams** tab, use the drop down arrows to change both the MIN and MAX BAR SIZE for TOP BARS to #9.
 - Use the drop down arrows to change both the MIN and MAX BAR SIZE for BOTTOM BARS to #8. Press OK.

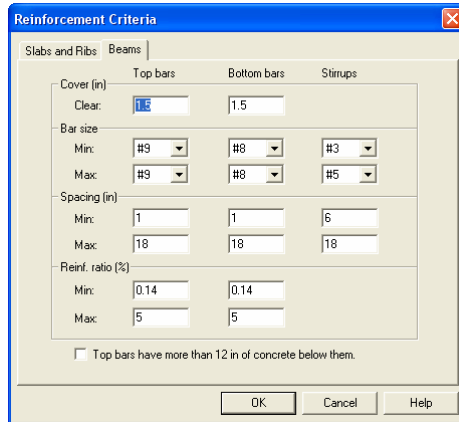

6. From the **Input** menu, select **Load Cases**. A dialog box appears.

- Since we are not considering lateral forces, click on WIND in the LABEL column on the list in the bottom half of the LOAD CASES dialog box and press the DELETE button.
- Click on EQ in the LABEL column and press the DELETE button. Press OK.

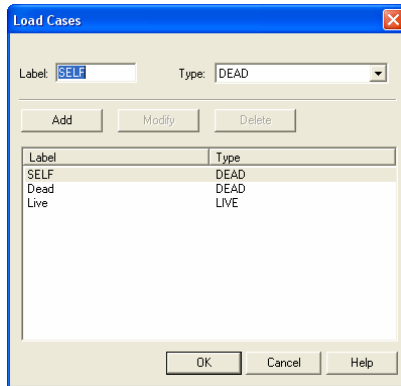

7. From the **Input** menu, select **Load Combinations**. A dialog box appears.
 - Delete all the load combinations by clicking anywhere on the list in the bottom half of the LOAD COMBINATIONS dialog box and pressing the DELETE button. Repeat this procedure until all the load combinations are gone.
 - Input 1 . 2 in the SELF field, 1 . 2 in the DEAD field, and 1 . 6 in the LIVE field. Press ADD.
 - Press OK.

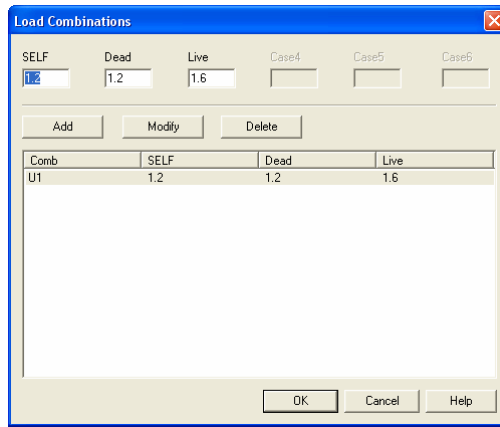

8. From the **Input** menu, select **Span Loads**. A dialog box appears.
 - Press the drop down arrow next to TYPE, and select LINE LOAD.
 - Input 1647.5 for both the START and END MAGNITUDE. (Note: This value was obtained by converting the area loads of the of the slab’s self weight (without the beam) and superimposed dead load into a line load.)

Dead Load =

$$\left(\frac{5}{12} \text{ ft} \times 150 \text{ pcf} \times 12 \text{ ft}\right) + (80 \text{ psf} * 12 \text{ ft}) - \left(\frac{5 \text{ in} \times 12 \text{ in}}{144 \text{ in}^2 / \text{ft}^2} \times 150 \text{ pcf}\right) =$$

$$= 1647.5 \text{ lb / ft}$$
 - Input 24 for the END LOCATION. Press ADD.
 - Click on SPAN 1 on the list in the bottom half of the SPAN LOADS dialog box. Press the COPY button. (Note: there is a CASE COPY button that should not be pressed.)
 - Click the check box next to SPAN 5 and press OK.
 - Back in the SPAN LOADS dialog box, use the drop down arrow next to SPAN to select SPAN 2. Keep the START and END MAGNITUDES of 1647.5 lb/ft but change the END LOCATION to 26. Click the ADD button.
 - Click on SPAN 2 in the list at the bottom half of the SPAN LOADS dialog box. Press the COPY button.
 - Click the check boxes next to SPAN 3 and 4. Press OK.

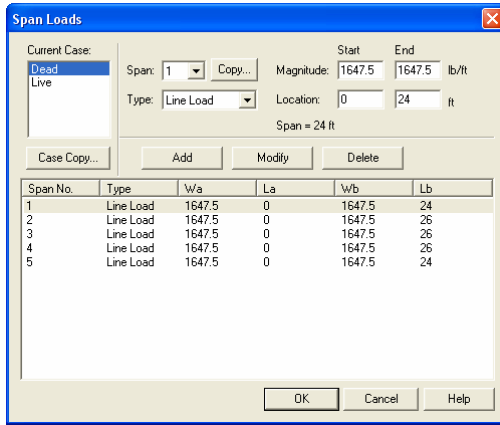

9. In the top left corner of the SPAN LOADS dialog box, there is a section called CURRENT CASE. Click on LIVE.

- Use the drop down arrow next to SPAN to select SPAN 1.
- Making sure that LINE LOAD is still the selected LOAD TYPE, input 1560 for both the START and END MAGNITUDE.

Live Load = $(130\text{psf} \times 12\text{ft}) = 1560\text{lb/ft}$

- Input 24 for the END LOCATION. Press ADD.
- Click on SPAN 1 on the list in the bottom half of the SPAN LOADS dialog box. Press the COPY button. (Note: the CASE COPY button should not be pressed.)
- Click the check box next to SPAN 5 and press OK.
- Back in the SPAN LOADS dialog box, use the drop down arrow next to SPANS to select SPAN 2. Keep the START and END MAGNITUDES of 1560 lb/ft but change the END LOCATION to 26. Click the ADD button.
- Click on SPAN 2 in the list at the bottom half of the SPAN LOADS dialog box. Press the COPY button.
- Click the check boxes next to SPAN 3 AND 4. Press OK.
- Press OK again.

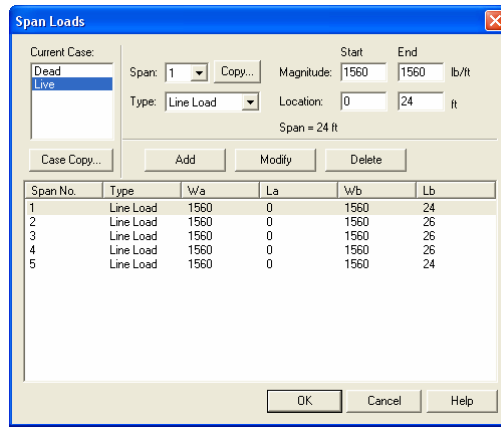

10. From the **Solve** menu, select **Execute**. Press CLOSE.
11. From the **Solve** menu, select **Results Report**.
 - Use the scroll bars to scroll through the results file.
 - Use the ARROW keys or the mouse wheel to browse through different parts of the results quickly. Press the CLOSE button to close the RESULTS REPORT dialog box and return to pcaBeam.
12. To view diagrams, select **Loads, Internal Forces, Moment Capacity, Shear Capacity, Deflection, or Reinforcement** from the **View** menu. Right click in any of these diagrams to get new copy, printing, or display options.
13. You may print the results file by selecting **Print Results** from the **File** menu. To print any of the diagrams you selected to view, use the **Print Preview** command found by right clicking in the diagram's window. After viewing the results, you may decide to investigate the input beams under the same loads but with a modified reinforcement configuration.
14. From the **Input** menu, select **General Information**. In the **General Information** dialog box change the RUN MODE option to INVESTIGATION. Do not change any of the other options. Press OK
15. From the **Input** menu, select the different commands under **Reinforcement Criteria and Reinforcing Bars** to modify the reinforcement configuration computed by the program.
16. Repeat steps 10 and subsequent to perform the investigation and view the results.

Text Output (abbreviated)

```

000000      00000      00000
00000000   00000000  00000000
00 00 00 00 00 00 00
00 00 00 00 00 00 00
00000000   00        00000000  00000
00000000   00 00    00000000  00000
00         00 00 00 00 00 00
00         00000000  00 00
00         000000  00 00

```

```

00000 000000 00000 00 00
00 00 00 00 00 00 000 000
00 00 00 00 00 00 00 0 0 00
00 00 00 00 00 00 00 0 0 00
00000 000000 00000000 00 0 00
00 00 00 00 00 00 00 00
00 00 00 00 00 00 00 00
00 00 00 00 00 00 00 00
00000 000000 00 00 00 00

```

```

=====
                          pcaBeam v1.50 (TM)
A Computer Program for Analysis, Design, and Investigation of
Reinforced Concrete Continuous Beam and One-Way Slab Systems
=====
Copyright © 1992-2005, Portland Cement Association
All rights reserved

```

Licensee stated above acknowledges that Portland Cement Association (PCA) is not and cannot be responsible for either the accuracy or adequacy of the material supplied as input for processing by the pcaBeam computer program. Furthermore, PCA neither makes any warranty expressed nor implied with respect to the correctness of the output prepared by the pcaBeam program. Although PCA has endeavored to produce pcaBeam error free the program is not and cannot be certified infallible. The final and only responsibility for analysis, design and engineering documents is the licensee. Accordingly, PCA disclaims all responsibility in contract, negligence or other tort for any analysis, design or engineering documents prepared in connection with the use of the pcaBeam program.

```

=====
[1] INPUT ECHO
=====

```

General Information:

```

=====
File name: C:\Data\pcaBeam\Hassoun Ex 16.1.slb
Project: Example 16.1 Hassoun and Al-Manaseer
Frame: Structural Concrete           Engineer: pcaStructurePoint
Code: ACI 318-02      Mode: Design   Reinforcement Database: ASTM A615
Number of supports = 6
Floor System: One-Way/Beam

```

```

Live load pattern ratio = 100%
Deflections are based on cracked section properties.
In negative moment regions, Igr and Mcr DO NOT include flange/slab contribution (if available)
Compression reinforcement calculations NOT selected.
Moment redistribution NOT selected.
Effective flange width calculations NOT selected.
Rigid beam-column joint NOT selected.
Torsion analysis and design NOT selected.

```

Material Properties:

```

=====
                Slabs|Beams          Columns
-----
wc =                150                150 lb/ft3
f'c =                4                  4 ksi
Ec =               3834.3              3834.3 ksi
fr =               0.47434            0.47434 ksi

fy =                60 ksi, Bars are not epoxy-coated
fyv =               60 ksi
Es =               29000 ksi
  
```

Reinforcement Database:

```

=====
Units: Db (in), Ab (in^2), Wb (lb/ft)
Size  Db      Ab      Wb      Size  Db      Ab      Wb
-----
#3    0.38    0.11    0.38    #4    0.50    0.20    0.67
#5    0.63    0.31    1.04    #6    0.75    0.44    1.50
#7    0.88    0.60    2.04    #8    1.00    0.79    2.67
#9    1.13    1.00    3.40    #10   1.27    1.27    4.30
#11   1.41    1.56    5.31    #14   1.69    2.25    7.65
#18   2.26    4.00    13.60
  
```

Span Data:

```

=====
Slabs: Ll, wL, wR (ft); t, Hmin (in)
Span Loc      Ll      t      wL      wR      Hmin
-----
1 Int         24.000  5.00  0.500  0.500  0.00
2 Int         26.000  5.00  0.500  0.500  0.00
3 Int         26.000  5.00  0.500  0.500  0.00
4 Int         26.000  5.00  0.500  0.500  0.00
5 Int         24.000  5.00  0.500  0.500  0.00
  
```

Ribs and Longitudinal Beams: b, h, Sp (in)

```

-----
                Ribs          Beams          Span
Span  b      h      Sp      b      h      Hmin
-----
1     0.00  0.00  0.00   12.00  22.00  15.57
2     0.00  0.00  0.00   12.00  22.00  14.86
3     0.00  0.00  0.00   12.00  22.00  14.86
4     0.00  0.00  0.00   12.00  22.00  14.86
5     0.00  0.00  0.00   12.00  22.00  15.57
  
```

Support Data:

```

=====
Columns: c1a, c2a, c1b, c2b (in); Ha, Hb (ft)
Supp  c1a  c2a  Ha  c1b  c2b  Hb  Red%
-----
1     12.00  12.00  13.000  12.00  12.00  13.000  100
2     12.00  12.00  13.000  12.00  12.00  13.000  100
3     12.00  12.00  13.000  12.00  12.00  13.000  100
4     12.00  12.00  13.000  12.00  12.00  13.000  100
5     12.00  12.00  13.000  12.00  12.00  13.000  100
6     12.00  12.00  13.000  12.00  12.00  13.000  100
  
```

Boundary Conditions: Kz (kip/in); Kry (kip-in/rad)

```

Supp  Spring Kz  Spring Kry  Far End A  Far End B
-----
1     0          0          Fixed      Fixed
2     0          0          Fixed      Fixed
3     0          0          Fixed      Fixed
4     0          0          Fixed      Fixed
5     0          0          Fixed      Fixed
6     0          0          Fixed      Fixed
  
```

Load Data:

=====

Load Cases and Combinations:

Case	SELF	Dead	Live
Type	DEAD	DEAD	LIVE
U1	1.200	1.200	1.600

Span Loads:

Span Case	Wa	La	Wb	Lb
-----	-----	-----	-----	-----

Line Loads - Wa | Wb (lb/ft), La | Lb (ft):

1 Dead	1647.5	0	1647.5	24
2 Dead	1647.5	0	1647.5	26
3 Dead	1647.5	0	1647.5	26
4 Dead	1647.5	0	1647.5	26
5 Dead	1647.5	0	1647.5	24
1 Live	1560	0	1560	24
2 Live	1560	0	1560	26
3 Live	1560	0	1560	26
4 Live	1560	0	1560	26
5 Live	1560	0	1560	24

Support Loads: --- NONE ---

Support Displacements: --- NONE ---

Reinforcement Criteria:

=====

	Top bars		Bottom bars		Stirrups	
	Min	Max	Min	Max	Min	Max
-----	-----	-----	-----	-----	-----	-----

Slabs and Ribs:

Bar Size	#9	#9	#8	#8
Bar spacing	1.00	18.00	1.00	18.00 in
Reinf ratio	0.14	5.00	0.14	5.00 %
Cover	1.50		1.50	in

Beams:

Bar Size	#9	#9	#8	#8	#3	#5
Bar spacing	1.00	18.00	1.00	18.00	6.00	18.00 in
Reinf ratio	0.14	5.00	0.14	5.00 %		
Cover	1.50		1.50	in		

[2] DESIGN RESULTS

=====

Top Reinforcement:

=====

Units: Width (ft), Mmax (k-ft), Xmax (ft), As (in^2), Sp (in)

Span Zone	Width	Mmax	Xmax	AsMin	AsMax	SpReq	AsReq	Bars
-----	-----	-----	-----	-----	-----	-----	-----	-----
1 Left	1.00	120.04	0.500	0.797	4.321	7.617	1.412	2-#9
Middle	1.00	0.00	12.000	0.000	4.321	0.000	0.000	---
Right	1.00	252.46	23.500	0.797	4.321	2.539	3.189	4-#9
2 Left	1.00	256.82	0.500	0.797	4.321	2.539	3.253	4-#9
Middle	1.00	0.00	13.000	0.000	4.321	0.000	0.000	---
Right	1.00	259.21	25.500	0.797	4.321	2.539	3.288	4-#9
3 Left	1.00	259.63	0.500	0.797	4.321	2.539	3.294	4-#9
Middle	1.00	0.00	13.000	0.000	4.321	0.000	0.000	---
Right	1.00	259.63	25.500	0.797	4.321	2.539	3.294	4-#9
4 Left	1.00	259.21	0.500	0.797	4.321	2.539	3.288	4-#9
Middle	1.00	0.00	13.000	0.000	4.321	0.000	0.000	---
Right	1.00	256.82	25.500	0.797	4.321	2.539	3.253	4-#9

5 Left	1.00	252.46	0.500	0.797	4.321	2.539	3.189	4-#9
Middle	1.00	0.00	12.000	0.000	4.321	0.000	0.000	---
Right	1.00	120.04	23.500	0.797	4.321	7.617	1.412	2-#9

Top Bar Details:

=====

Units: Length (ft)

Span	Left				Continuous		Right			
	Bars	Length	Bars	Length	Bars	Length	Bars	Length	Bars	Length
1	1-#9	8.09	1-#9	5.10	---	---	2-#9	12.24	2-#9	6.72
2	2-#9	12.08	2-#9	6.88	---	---	2-#9	12.39	2-#9	6.97
3	2-#9	12.39	2-#9	6.99	---	---	2-#9	12.39	2-#9	6.99
4	2-#9	12.39	2-#9	6.97	---	---	2-#9	12.08	2-#9	6.88
5	2-#9	12.24	2-#9	6.72	---	---	1-#9	8.09	1-#9	5.10

Bottom Reinforcement:

=====

Units: Width (ft), Mmax (k-ft), Xmax (ft), As (in^2), Sp (in)

Span	Width	Mmax	Xmax	AsMin	AsMax	SpReq	AsReq	Bars
1	1.00	159.13	11.250	0.800	4.335	3.853	1.899	3-#8
2	1.00	161.64	13.000	0.800	4.335	3.853	1.925	3-#8
3	1.00	164.05	13.000	0.800	4.335	3.853	1.964	3-#8
4	1.00	161.64	13.000	0.800	4.335	3.853	1.925	3-#8
5	1.00	159.13	12.750	0.800	4.335	3.853	1.899	3-#8

Bottom Bar Details:

=====

Units: Start (ft), Length (ft)

Span	Long Bars			Short Bars		
	Bars	Start	Length	Bars	Start	Length
1	2-#8	0.00	24.00	1-#8	5.58	11.41
2	2-#8	0.00	26.00	1-#8	7.20	11.79
3	2-#8	0.00	26.00	1-#8	6.91	12.18
4	2-#8	0.00	26.00	1-#8	7.01	11.79
5	2-#8	0.00	24.00	1-#8	7.01	11.41

Flexural Capacity:

=====

Units: From, To (ft), As (in^2), PhiMn (k-ft)

Span	From	To	AsTop		AsBot		PhiMn-	PhiMn+
			AsTop	AsBot	AsTop	AsBot		
1	0.000	0.500	2.00	1.58	-166.19	133.94		
	0.500	2.521	2.00	1.58	-166.19	133.94		
	2.521	5.101	1.00	1.58	-86.40	133.94		
	5.101	5.511	1.00	1.58	-86.40	133.94		
	5.511	5.578	0.00	1.58	0.00	133.94		
	5.578	8.044	0.00	1.58	0.00	133.94		
	8.044	8.090	0.00	2.37	0.00	194.71		
	8.090	8.550	0.00	2.37	0.00	194.71		
	8.550	11.761	0.00	2.37	0.00	194.71		
	11.761	12.000	0.00	2.37	0.00	194.71		
	12.000	14.520	0.00	2.37	0.00	194.71		

	14.520	15.450	0.00	1.58	0.00	133.94
	15.450	16.500	0.00	1.58	0.00	133.94
	16.500	16.986	2.00	1.58	-166.19	133.94
	16.986	17.277	2.00	1.58	-166.19	133.94
	17.277	22.015	2.00	1.58	-166.19	133.94
	22.015	23.500	4.00	1.58	-305.91	133.94
	23.500	24.000	4.00	1.58	-305.91	133.94
2	0.000	0.500	4.00	1.58	-305.91	133.94
	0.500	2.047	4.00	1.58	-305.91	133.94
	2.047	6.881	2.00	1.58	-166.19	133.94
	6.881	7.201	2.00	1.58	-166.19	133.94
	7.201	7.250	2.00	1.58	-166.19	133.94
	7.250	9.250	0.00	1.58	0.00	133.94
	9.250	9.701	0.00	1.58	0.00	133.94
	9.701	12.083	0.00	2.37	0.00	194.71
	12.083	13.000	0.00	2.37	0.00	194.71
	13.000	13.615	0.00	2.37	0.00	194.71
	13.615	16.494	0.00	2.37	0.00	194.71
	16.494	16.750	0.00	1.58	0.00	133.94
	16.750	18.500	0.00	1.58	0.00	133.94
	18.500	18.994	2.00	1.58	-166.19	133.94
	18.994	19.025	2.00	1.58	-166.19	133.94
	19.025	23.911	2.00	1.58	-166.19	133.94
	23.911	25.500	4.00	1.58	-305.91	133.94
	25.500	26.000	4.00	1.58	-305.91	133.94
3	0.000	0.500	4.00	1.58	-305.91	133.94
	0.500	2.094	4.00	1.58	-305.91	133.94
	2.094	6.910	2.00	1.58	-166.19	133.94
	6.910	6.989	2.00	1.58	-166.19	133.94
	6.989	7.500	2.00	1.58	-166.19	133.94
	7.500	9.250	0.00	1.58	0.00	133.94
	9.250	9.460	0.00	1.58	0.00	133.94
	9.460	12.395	0.00	2.37	0.00	194.71
	12.395	13.000	0.00	2.37	0.00	194.71
	13.000	13.605	0.00	2.37	0.00	194.71
	13.605	16.540	0.00	2.37	0.00	194.71
	16.540	16.750	0.00	1.58	0.00	133.94
	16.750	18.500	0.00	1.58	0.00	133.94
	18.500	19.011	2.00	1.58	-166.19	133.94
	19.011	19.090	2.00	1.58	-166.19	133.94
	19.090	23.906	2.00	1.58	-166.19	133.94
	23.906	25.500	4.00	1.58	-305.91	133.94
	25.500	26.000	4.00	1.58	-305.91	133.94
4	0.000	0.500	4.00	1.58	-305.91	133.94
	0.500	2.089	4.00	1.58	-305.91	133.94
	2.089	6.975	2.00	1.58	-166.19	133.94
	6.975	7.006	2.00	1.58	-166.19	133.94
	7.006	7.500	2.00	1.58	-166.19	133.94
	7.500	9.250	0.00	1.58	0.00	133.94
	9.250	9.506	0.00	1.58	0.00	133.94
	9.506	12.385	0.00	2.37	0.00	194.71
	12.385	13.000	0.00	2.37	0.00	194.71
	13.000	13.917	0.00	2.37	0.00	194.71
	13.917	16.299	0.00	2.37	0.00	194.71
	16.299	16.750	0.00	1.58	0.00	133.94
	16.750	18.750	0.00	1.58	0.00	133.94
	18.750	18.799	2.00	1.58	-166.19	133.94
	18.799	19.119	2.00	1.58	-166.19	133.94
	19.119	23.953	2.00	1.58	-166.19	133.94
	23.953	25.500	4.00	1.58	-305.91	133.94
	25.500	26.000	4.00	1.58	-305.91	133.94
5	0.000	0.500	4.00	1.58	-305.91	133.94
	0.500	1.985	4.00	1.58	-305.91	133.94
	1.985	6.723	2.00	1.58	-166.19	133.94

6.723	7.014	2.00	1.58	-166.19	133.94
7.014	7.500	2.00	1.58	-166.19	133.94
7.500	8.550	0.00	1.58	0.00	133.94
8.550	9.480	0.00	1.58	0.00	133.94
9.480	12.000	0.00	2.37	0.00	194.71
12.000	12.239	0.00	2.37	0.00	194.71
12.239	15.450	0.00	2.37	0.00	194.71
15.450	15.910	0.00	2.37	0.00	194.71
15.910	15.956	0.00	2.37	0.00	194.71
15.956	18.422	0.00	1.58	0.00	133.94
18.422	18.489	0.00	1.58	0.00	133.94
18.489	18.899	1.00	1.58	-86.40	133.94
18.899	21.479	1.00	1.58	-86.40	133.94
21.479	23.500	2.00	1.58	-166.19	133.94
23.500	24.000	2.00	1.58	-166.19	133.94

Longitudinal Beam Shear Reinforcement Required:

```

=====
Units: d (in), Start, End, Xu (ft), PhiVc, Vu (kip), Av/s (in^2/in)
-----
Span   d      PhiVc   Start   End      Vu      Xu      Av/s
-----
1      19.94   22.70    2.161   4.972    43.81   2.161   0.0235
        4.972   7.783    30.31   4.972    30.31   4.972   0.0100
        7.783   10.594   16.80   7.783    16.80   7.783   0.0100
        10.594  13.406   13.20   13.406   13.20   13.406  0.0100
        13.406  16.217   26.70   16.217   26.70   16.217  0.0100
        16.217  19.028   40.20   19.028   40.20   19.028  0.0195
        19.028  21.839   53.70   21.839   53.70   21.839  0.0346

2      19.94   22.70    2.161   5.258    54.33   2.161   0.0353
        5.258   8.355    39.45   5.258    39.45   5.258   0.0187
        8.355   11.452   24.58   8.355    24.58   8.355   0.0100
        11.452  14.548   9.78    14.548   9.78    14.548  0.0000
        14.548  17.645   24.65   17.645   24.65   17.645  0.0100
        17.645  20.742   39.52   20.742   39.52   20.742  0.0188
        20.742  23.839   54.40   23.839   54.40   23.839  0.0353

3      19.94   22.70    2.161   5.258    54.49   2.161   0.0354
        5.258   8.355    39.61   5.258    39.61   5.258   0.0189
        8.355   11.452   24.74   8.355    24.74   8.355   0.0100
        11.452  14.548   9.87    14.548   9.87    14.548  0.0000
        14.548  17.645   24.74   17.645   24.74   17.645  0.0100
        17.645  20.742   39.61   20.742   39.61   20.742  0.0189
        20.742  23.839   54.49   23.839   54.49   23.839  0.0354

4      19.94   22.70    2.161   5.258    54.40   2.161   0.0353
        5.258   8.355    39.52   5.258    39.52   5.258   0.0188
        8.355   11.452   24.65   8.355    24.65   8.355   0.0100
        11.452  14.548   9.78    14.548   9.78    14.548  0.0000
        14.548  17.645   24.58   17.645   24.58   17.645  0.0100
        17.645  20.742   39.45   20.742   39.45   20.742  0.0187
        20.742  23.839   54.33   23.839   54.33   23.839  0.0353

5      19.94   22.70    2.161   4.972    53.70   2.161   0.0346
        4.972   7.783    40.20   4.972    40.20   4.972   0.0195
        7.783   10.594   26.70   7.783    26.70   7.783   0.0100
        10.594  13.406   13.20   13.406   13.20   13.406  0.0100
        13.406  16.217   16.80   16.217   16.80   16.217  0.0100
        16.217  19.028   30.31   19.028   30.31   19.028  0.0100
        19.028  21.839   43.81   21.839   43.81   21.839  0.0235

```

Longitudinal Beam Shear Reinforcement Details:

```

=====
Units: spacing & distance (in).
Span Size Stirrups (2 legs each unless otherwise noted)
-----
1      #3 6 @ 8.4 + 17 @ 9.9 + 10 @ 5.6

```

2 #3 10 @ 5.4 + 9 @ 9.3 + <-- 37.2 --> + 8 @ 9.3 + 11 @ 5.4
 3 #3 10 @ 5.4 + 9 @ 9.3 + <-- 37.2 --> + 8 @ 9.3 + 11 @ 5.4
 4 #3 10 @ 5.4 + 9 @ 9.3 + <-- 37.2 --> + 8 @ 9.3 + 11 @ 5.4
 5 #3 9 @ 5.6 + 17 @ 9.9 + 7 @ 8.4

Beam Shear Capacity:

=====

Units: d, Sp (in), Start, End, Xu (ft), PhiVc, PhiVn, Vu (kip), Av/s (in^2/in)											
Span	d	Sp	PhiVc	Start	End	Xu	PhiVc	PhiVn	Vu	Av/s	
1	19.94	22.70		0.000	0.750				46.07	54.19	0.000
				0.750	4.972	0.0261	8.4	46.07	43.81	2.161	
				4.972	19.028	0.0222	9.9	42.59	40.20	19.028	
				19.028	23.250	0.0391	5.6	57.75	53.70	21.839	
				23.250	24.000			57.75	64.08	24.000	
2	19.94	22.70		0.000	0.750			59.18	64.71	0.000	
				0.750	5.258	0.0407	5.4	59.18	54.33	2.161	
				5.258	11.452	0.0237	9.3	43.94	39.45	5.258	
				11.452	14.548			11.35	9.78	14.548	
				14.548	20.742	0.0237	9.3	43.94	39.52	20.742	
3	19.94	22.70		0.000	0.750			59.18	64.87	0.000	
				0.750	5.258	0.0407	5.4	59.18	54.49	2.161	
				5.258	11.452	0.0237	9.3	43.94	39.61	5.258	
				11.452	14.548			11.35	9.87	14.548	
				14.548	20.742	0.0237	9.3	43.94	39.61	20.742	
4	19.94	22.70		0.000	0.750			59.18	64.78	0.000	
				0.750	5.258	0.0407	5.4	59.18	54.40	2.161	
				5.258	11.452	0.0237	9.3	43.94	39.52	5.258	
				11.452	14.548			11.35	9.78	11.452	
				14.548	20.742	0.0237	9.3	43.94	39.45	20.742	
5	19.94	22.70		0.000	0.750			57.75	64.08	0.000	
				0.750	4.972	0.0391	5.6	57.75	53.70	2.161	
				4.972	19.028	0.0222	9.9	42.59	40.20	4.972	
				19.028	23.250	0.0261	8.4	46.07	43.81	21.839	
				23.250	24.000			46.07	54.19	24.000	

Slab Shear Capacity:

=====

Units: b, d (in), Xu (ft), PhiVc, Vu (kip)						
Span	b	d	Vratio	PhiVc	Vu	Xu
1	---	---	Not checked	---	---	---
2	---	---	Not checked	---	---	---
3	---	---	Not checked	---	---	---
4	---	---	Not checked	---	---	---
5	---	---	Not checked	---	---	---

Maximum Deflections:

=====

Units: Dz (in)			
Span	Dz(DEAD)	Dz(LIVE)	Dz(TOTAL)
1	-0.276	-0.273	-0.549
2	-0.268	-0.239	-0.506
3	-0.269	-0.238	-0.507
4	-0.268	-0.239	-0.506
5	-0.276	-0.273	-0.549

Material Takeoff:

=====

Reinforcement in the Direction of Analysis

Top Bars:	1132.4 lb	<=>	8.99 lb/ft	<=>	8.987 lb/ft^2
Bottom Bars:	829.3 lb	<=>	6.58 lb/ft	<=>	6.581 lb/ft^2
Stirrups:	947.5 lb	<=>	7.52 lb/ft	<=>	7.520 lb/ft^2
Total Steel:	2909.2 lb	<=>	23.09 lb/ft	<=>	23.089 lb/ft^2
Concrete:	178.5 ft^3	<=>	1.42 ft^3/ft	<=>	1.417 ft^3/ft^2

[3] COLUMN AXIAL FORCES AND MOMENTS

=====

Units: P (kip), M (k-ft)

Supp Case/Patt	P (axial)	Mb[top]	Ma[bottom]
1 SELF	2.95	-3.76	-3.76
Dead	17.68	-22.50	-22.50
Live/All	16.74	-21.31	-21.31
Live/Odd	18.40	-26.10	-26.10
Live/Even	-1.66	4.80	4.80
Live/S1	18.15	-25.38	-25.38
Live/S2	16.52	-20.69	-20.69
Live/S3	-1.38	3.99	3.99
Live/S4	0.21	-0.60	-0.60
Live/S5	-0.03	0.09	0.09
Live/S6	0.00	-0.01	-0.01
2 SELF	7.23	0.12	0.12
Dead	43.33	0.74	0.74
Live/All	41.03	0.70	0.70
Live/Odd	18.84	22.75	22.75
Live/Even	22.19	-22.05	-22.05
Live/S1	20.65	19.45	19.45
Live/S2	42.57	-2.11	-2.11
Live/S3	20.15	-18.33	-18.33
Live/S4	-1.50	2.75	2.75
Live/S5	0.23	-0.42	-0.42
Live/S6	-0.04	0.06	0.06
3 SELF	7.14	-0.02	-0.02
Dead	42.78	-0.13	-0.13
Live/All	40.51	-0.12	-0.12
Live/Odd	20.48	-25.18	-25.18
Live/Even	20.03	25.06	25.06
Live/S1	-1.56	-2.92	-2.92
Live/S2	20.22	18.87	18.87
Live/S3	43.58	-0.03	-0.03
Live/S4	20.06	-18.55	-18.55
Live/S5	-1.51	2.83	2.83
Live/S6	0.23	-0.44	-0.44
4 SELF	7.14	0.02	0.02
Dead	42.78	0.13	0.13
Live/All	40.51	0.12	0.12
Live/Odd	20.48	25.18	25.18
Live/Even	20.03	-25.06	-25.06
Live/S1	0.23	0.44	0.44
Live/S2	-1.51	-2.83	-2.83
Live/S3	20.06	18.55	18.55
Live/S4	43.58	0.03	0.03
Live/S5	20.22	-18.87	-18.87
Live/S6	-1.56	2.92	2.92

5 SELF	7.23	-0.12	-0.12
Dead	43.33	-0.74	-0.74
Live/All	41.03	-0.70	-0.70
Live/Odd	18.84	-22.75	-22.75
Live/Even	22.19	22.05	22.05
Live/S1	-0.04	-0.06	-0.06
Live/S2	0.23	0.42	0.42
Live/S3	-1.50	-2.75	-2.75
Live/S4	20.15	18.33	18.33
Live/S5	42.57	2.11	2.11
Live/S6	20.65	-19.45	-19.45
6 SELF	2.95	3.76	3.76
Dead	17.68	22.50	22.50
Live/All	16.74	21.31	21.31
Live/Odd	18.40	26.10	26.10
Live/Even	-1.66	-4.80	-4.80
Live/S1	0.00	0.01	0.01
Live/S2	-0.03	-0.09	-0.09
Live/S3	0.21	0.60	0.60
Live/S4	-1.38	-3.99	-3.99
Live/S5	16.52	20.69	20.69
Live/S6	18.15	25.38	25.38
Sum SELF	34.65	0.00	0.00
Dead	207.59	0.00	0.00
Live/All	196.56	0.00	0.00
Live/Odd	115.44	0.00	0.00
Live/Even	81.12	-0.00	-0.00
Live/S1	37.44	-8.47	-8.47
Live/S2	78.00	-6.44	-6.44
Live/S3	81.12	2.03	2.03
Live/S4	81.12	-2.03	-2.03
Live/S5	78.00	6.44	6.44
Live/S6	37.44	8.47	8.47

=====

[6] SEGMENTAL MOMENT AND SHEAR - ENVELOPES

=====

Span	x (ft)	M- (k-ft) Comb	M+ (k-ft) Comb	V- (kip) Comb	V+ (kip) Comb
1	0.000	-146.54 U1	0.00 U1	0.00 U1	54.19 U1
	0.250	-133.14 U1	0.00 U1	0.00 U1	52.99 U1
	0.500	-120.04 U1	0.00 U1	0.00 U1	51.79 U1
	0.500	-120.04 U1	0.00 U1	0.00 U1	51.79 U1
	0.750	-107.25 U1	0.00 U1	0.00 U1	50.59 U1
	1.000	-94.75 U1	0.00 U1	0.00 U1	49.38 U1
	1.250	-82.56 U1	0.00 U1	0.00 U1	48.18 U1
	1.500	-70.66 U1	0.00 U1	0.00 U1	46.98 U1
	1.750	-59.06 U1	0.00 U1	0.00 U1	45.78 U1
	2.000	-47.77 U1	0.00 U1	0.00 U1	44.58 U1
	2.250	-36.77 U1	0.00 U1	0.00 U1	43.38 U1
	2.500	-26.08 U1	0.36 U1	0.00 U1	42.18 U1
	2.750	-15.68 U1	4.37 U1	0.00 U1	40.98 U1
	3.000	-5.59 U1	8.23 U1	0.00 U1	39.78 U1
	3.250	0.00 U1	11.95 U1	0.00 U1	38.58 U1
	3.500	0.00 U1	20.52 U1	0.00 U1	37.38 U1
	3.750	0.00 U1	28.97 U1	0.00 U1	36.18 U1
	4.000	0.00 U1	37.11 U1	0.00 U1	34.98 U1
	4.250	0.00 U1	44.95 U1	0.00 U1	33.77 U1
	4.500	0.00 U1	52.50 U1	0.00 U1	32.57 U1
	4.750	0.00 U1	59.74 U1	0.00 U1	31.37 U1
	5.000	0.00 U1	66.69 U1	0.00 U1	30.17 U1
	5.250	0.00 U1	73.33 U1	0.00 U1	28.97 U1
	5.500	0.00 U1	79.68 U1	0.00 U1	27.77 U1
	5.750	0.00 U1	85.72 U1	0.00 U1	26.57 U1

6.000	0.00 U1	92.13 U1	0.00 U1	25.37 U1
6.250	0.00 U1	98.33 U1	0.00 U1	24.17 U1
6.500	0.00 U1	104.22 U1	0.00 U1	22.97 U1
6.750	0.00 U1	109.81 U1	0.00 U1	21.77 U1
7.000	0.00 U1	115.10 U1	0.00 U1	20.57 U1
7.250	0.00 U1	120.09 U1	0.00 U1	19.37 U1
7.500	0.00 U1	124.78 U1	0.00 U1	18.16 U1
7.750	0.00 U1	129.18 U1	0.00 U1	16.96 U1
8.000	0.00 U1	133.27 U1	0.00 U1	15.76 U1
8.250	0.00 U1	137.06 U1	0.00 U1	14.56 U1
8.500	0.00 U1	140.55 U1	0.00 U1	13.36 U1
8.750	0.00 U1	143.74 U1	0.00 U1	12.16 U1
9.000	0.00 U1	146.63 U1	0.00 U1	10.96 U1
9.250	0.00 U1	149.22 U1	0.00 U1	9.76 U1
9.500	0.00 U1	151.51 U1	0.00 U1	8.56 U1
9.750	0.00 U1	153.50 U1	-0.40 U1	7.36 U1
10.000	0.00 U1	155.19 U1	-0.98 U1	6.16 U1
10.250	0.00 U1	156.58 U1	-1.55 U1	4.96 U1
10.500	0.00 U1	157.67 U1	-2.13 U1	3.76 U1
10.750	0.00 U1	158.45 U1	-2.71 U1	2.56 U1
11.000	0.00 U1	158.94 U1	-3.28 U1	1.35 U1
11.250	0.00 U1	159.13 U1	-3.86 U1	0.15 U1
11.500	0.00 U1	159.02 U1	-4.44 U1	0.00 U1
11.750	0.00 U1	158.61 U1	-5.24 U1	0.00 U1
12.000	0.00 U1	157.90 U1	-6.44 U1	0.00 U1
12.250	0.00 U1	156.88 U1	-7.65 U1	0.00 U1
12.500	0.00 U1	155.57 U1	-8.85 U1	0.00 U1
12.750	0.00 U1	153.96 U1	-10.05 U1	0.00 U1
13.000	0.00 U1	152.05 U1	-11.25 U1	0.00 U1
13.250	0.00 U1	149.83 U1	-12.45 U1	0.00 U1
13.500	0.00 U1	147.32 U1	-13.65 U1	0.00 U1
13.750	0.00 U1	144.51 U1	-14.85 U1	0.00 U1
14.000	0.00 U1	141.39 U1	-16.05 U1	0.00 U1
14.250	0.00 U1	137.98 U1	-17.25 U1	0.00 U1
14.500	0.00 U1	134.27 U1	-18.45 U1	0.00 U1
14.750	0.00 U1	130.25 U1	-19.65 U1	0.00 U1
15.000	0.00 U1	125.94 U1	-20.85 U1	0.00 U1
15.250	0.00 U1	121.32 U1	-22.05 U1	0.00 U1
15.500	0.00 U1	116.41 U1	-23.26 U1	0.00 U1
15.750	0.00 U1	111.19 U1	-24.46 U1	0.00 U1
16.000	0.00 U1	105.68 U1	-25.66 U1	0.00 U1
16.250	0.00 U1	99.86 U1	-26.86 U1	0.00 U1
16.500	0.00 U1	93.75 U1	-28.06 U1	0.00 U1
16.750	-1.21 U1	87.33 U1	-29.26 U1	0.00 U1
17.000	-5.42 U1	80.62 U1	-30.46 U1	0.00 U1
17.250	-9.77 U1	73.60 U1	-31.66 U1	0.00 U1
17.500	-14.27 U1	66.28 U1	-32.86 U1	0.00 U1
17.750	-18.91 U1	58.67 U1	-34.06 U1	0.00 U1
18.000	-23.70 U1	50.75 U1	-35.26 U1	0.00 U1
18.250	-28.63 U1	42.53 U1	-36.46 U1	0.00 U1
18.500	-33.70 U1	34.02 U1	-37.66 U1	0.00 U1
18.750	-38.92 U1	25.20 U1	-38.86 U1	0.00 U1
19.000	-44.28 U1	16.08 U1	-40.07 U1	0.00 U1
19.250	-49.79 U1	6.67 U1	-41.27 U1	0.00 U1
19.500	-55.44 U1	0.00 U1	-42.47 U1	0.00 U1
19.750	-61.23 U1	0.00 U1	-43.67 U1	0.00 U1
20.000	-67.17 U1	0.00 U1	-44.87 U1	0.00 U1
20.250	-73.37 U1	0.00 U1	-46.07 U1	0.00 U1
20.500	-79.04 U1	0.00 U1	-47.27 U1	0.00 U1
20.750	-101.01 U1	0.00 U1	-48.47 U1	0.00 U1
21.000	-113.27 U1	0.00 U1	-49.67 U1	0.00 U1
21.250	-125.84 U1	0.00 U1	-50.87 U1	0.00 U1
21.500	-138.71 U1	0.00 U1	-52.07 U1	0.00 U1
21.750	-151.88 U1	0.00 U1	-53.27 U1	0.00 U1
22.000	-165.35 U1	0.00 U1	-54.47 U1	0.00 U1
22.250	-179.11 U1	0.00 U1	-55.68 U1	0.00 U1
22.500	-193.18 U1	0.00 U1	-56.88 U1	0.00 U1
22.750	-207.55 U1	0.00 U1	-58.08 U1	0.00 U1

23.000	-222.22 U1	0.00 U1	-59.28 U1	0.00 U1
23.250	-237.19 U1	0.00 U1	-60.48 U1	0.00 U1
23.500	-252.46 U1	0.00 U1	-61.68 U1	0.00 U1
23.500	-252.46 U1	0.00 U1	-61.68 U1	0.00 U1
23.750	-268.03 U1	0.00 U1	-62.88 U1	0.00 U1
24.000	-283.90 U1	0.00 U1	-64.08 U1	0.00 U1

=====

[7] SEGMENTAL DEFLECTIONS

=====

Units: x (ft), Dz (in)

Span	x	Dz (DEAD)	Dz (LIVE)	Dz (TOTAL)
1	0.000	-0.000	-0.000	-0.000
	0.250	-0.006	-0.006	-0.012
	0.500	-0.013	-0.012	-0.025
	0.500	-0.013	-0.012	-0.025
	0.750	-0.020	-0.018	-0.038
	1.000	-0.027	-0.025	-0.052
	1.250	-0.035	-0.032	-0.067
	1.500	-0.043	-0.039	-0.082
	1.750	-0.051	-0.047	-0.098
	2.000	-0.060	-0.055	-0.115
	2.250	-0.068	-0.063	-0.131
	2.500	-0.077	-0.071	-0.148
	2.750	-0.085	-0.080	-0.165
	3.000	-0.094	-0.088	-0.183
	3.250	-0.103	-0.097	-0.200
	3.500	-0.112	-0.106	-0.218
	3.750	-0.121	-0.115	-0.235
	4.000	-0.129	-0.123	-0.253
	4.250	-0.138	-0.132	-0.270
	4.500	-0.147	-0.140	-0.287
	4.750	-0.155	-0.149	-0.304
	5.000	-0.164	-0.157	-0.321
	5.250	-0.172	-0.166	-0.337
	5.500	-0.180	-0.174	-0.353
	5.750	-0.188	-0.181	-0.369
	6.000	-0.195	-0.189	-0.384
	6.250	-0.202	-0.196	-0.399
	6.500	-0.209	-0.204	-0.413
	6.750	-0.216	-0.211	-0.427
	7.000	-0.223	-0.217	-0.440
	7.250	-0.229	-0.223	-0.452
	7.500	-0.235	-0.229	-0.464
	7.750	-0.240	-0.235	-0.475
	8.000	-0.245	-0.240	-0.486
	8.250	-0.250	-0.245	-0.495
	8.500	-0.254	-0.250	-0.504
	8.750	-0.258	-0.254	-0.512
	9.000	-0.262	-0.258	-0.520
	9.250	-0.265	-0.261	-0.526
	9.500	-0.268	-0.264	-0.532
	9.750	-0.270	-0.267	-0.537
	10.000	-0.272	-0.269	-0.541
	10.250	-0.274	-0.271	-0.545
	10.500	-0.275	-0.272	-0.547
	10.750	-0.276	-0.273	-0.549
	11.000	-0.276	-0.273	-0.549
	11.250	-0.276	-0.273	-0.549
	11.500	-0.275	-0.273	-0.548
	11.750	-0.275	-0.272	-0.547
	12.000	-0.273	-0.271	-0.544
	12.250	-0.271	-0.269	-0.541
	12.500	-0.269	-0.267	-0.536
	12.750	-0.267	-0.265	-0.531
	13.000	-0.264	-0.262	-0.525
	13.250	-0.260	-0.258	-0.518

13.500	-0.256	-0.255	-0.511
13.750	-0.252	-0.250	-0.503
14.000	-0.248	-0.246	-0.494
14.250	-0.243	-0.241	-0.484
14.500	-0.238	-0.236	-0.474
14.750	-0.232	-0.230	-0.463
15.000	-0.226	-0.225	-0.451
15.250	-0.220	-0.218	-0.439
15.500	-0.214	-0.212	-0.426
15.750	-0.207	-0.205	-0.412
16.000	-0.200	-0.198	-0.398
16.250	-0.193	-0.191	-0.384
16.500	-0.185	-0.184	-0.369
16.750	-0.178	-0.176	-0.354
17.000	-0.170	-0.168	-0.339
17.250	-0.162	-0.160	-0.323
17.500	-0.154	-0.152	-0.307
17.750	-0.146	-0.144	-0.290
18.000	-0.138	-0.136	-0.274
18.250	-0.130	-0.128	-0.257
18.500	-0.122	-0.119	-0.241
18.750	-0.113	-0.111	-0.224
19.000	-0.105	-0.103	-0.208
19.250	-0.097	-0.095	-0.192
19.500	-0.089	-0.087	-0.175
19.750	-0.081	-0.079	-0.160
20.000	-0.073	-0.071	-0.144
20.250	-0.066	-0.063	-0.129
20.500	-0.058	-0.056	-0.114
20.750	-0.051	-0.049	-0.100
21.000	-0.044	-0.042	-0.086
21.250	-0.038	-0.036	-0.074
21.500	-0.032	-0.030	-0.062
21.750	-0.026	-0.024	-0.050
22.000	-0.021	-0.019	-0.040
22.250	-0.016	-0.014	-0.031
22.500	-0.012	-0.010	-0.022
22.750	-0.008	-0.007	-0.015
23.000	-0.005	-0.004	-0.010
23.250	-0.003	-0.002	-0.005
23.500	-0.001	-0.001	-0.002
23.500	-0.001	-0.001	-0.002
23.750	-0.000	-0.000	-0.001
24.000	-0.000	-0.000	-0.000

Graphical Output

Loads

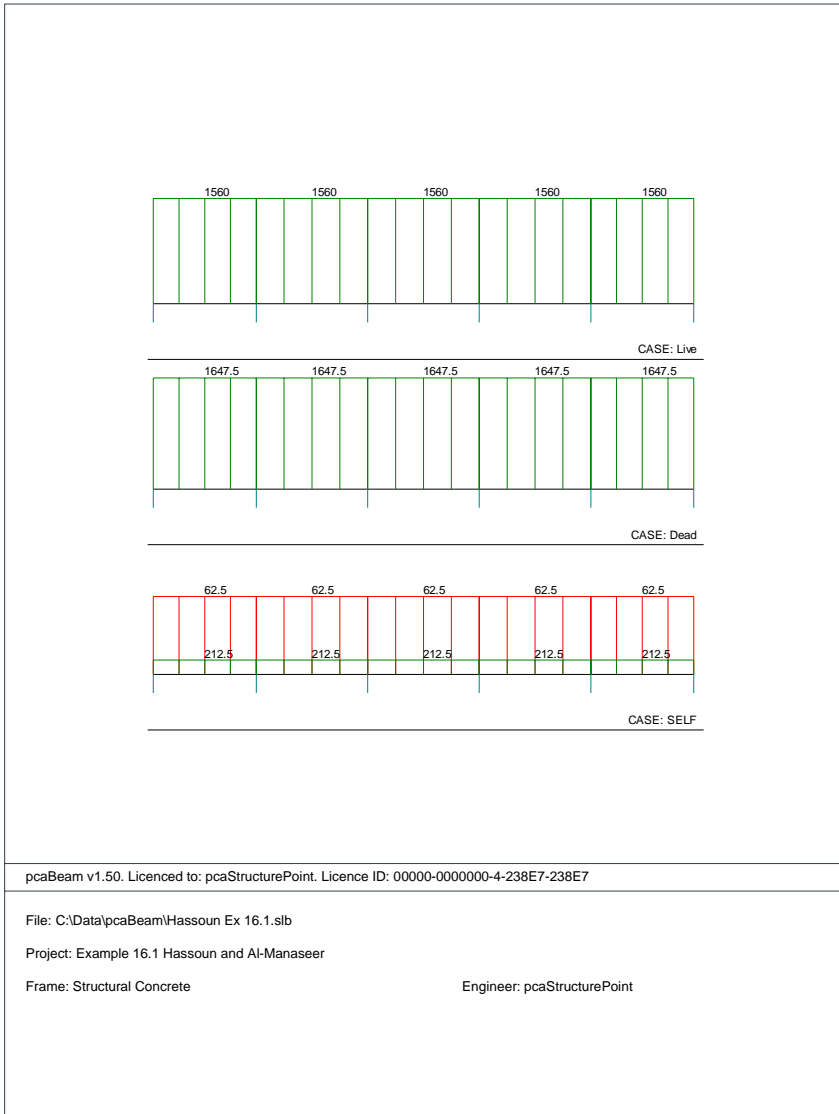

Internal Forces

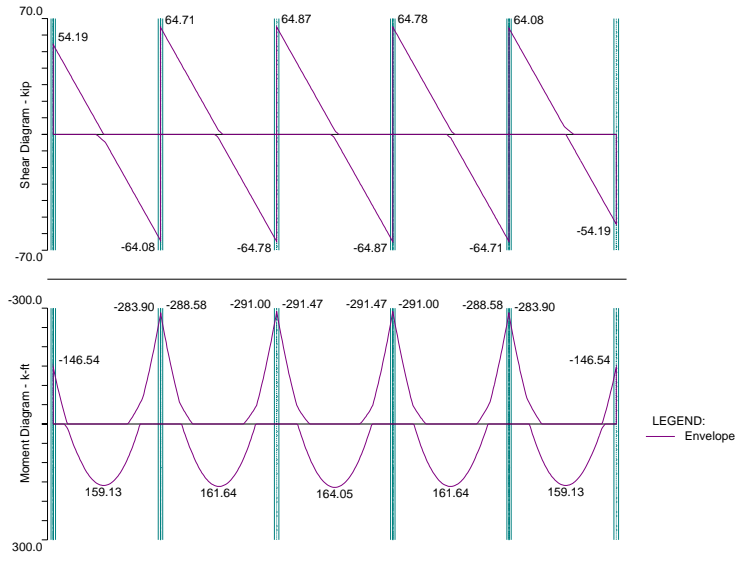

pcaBeam v1.50. Licenced to: pcaStructurePoint. Licence ID: 00000-0000000-4-238E7-238E7

File: C:\Data\pcaBeam\Hassoun Ex 16.1.slb

Project: Example 16.1 Hassoun and Al-Manaseer

Frame: Structural Concrete

Engineer: pcaStructurePoint

Moment Capacity

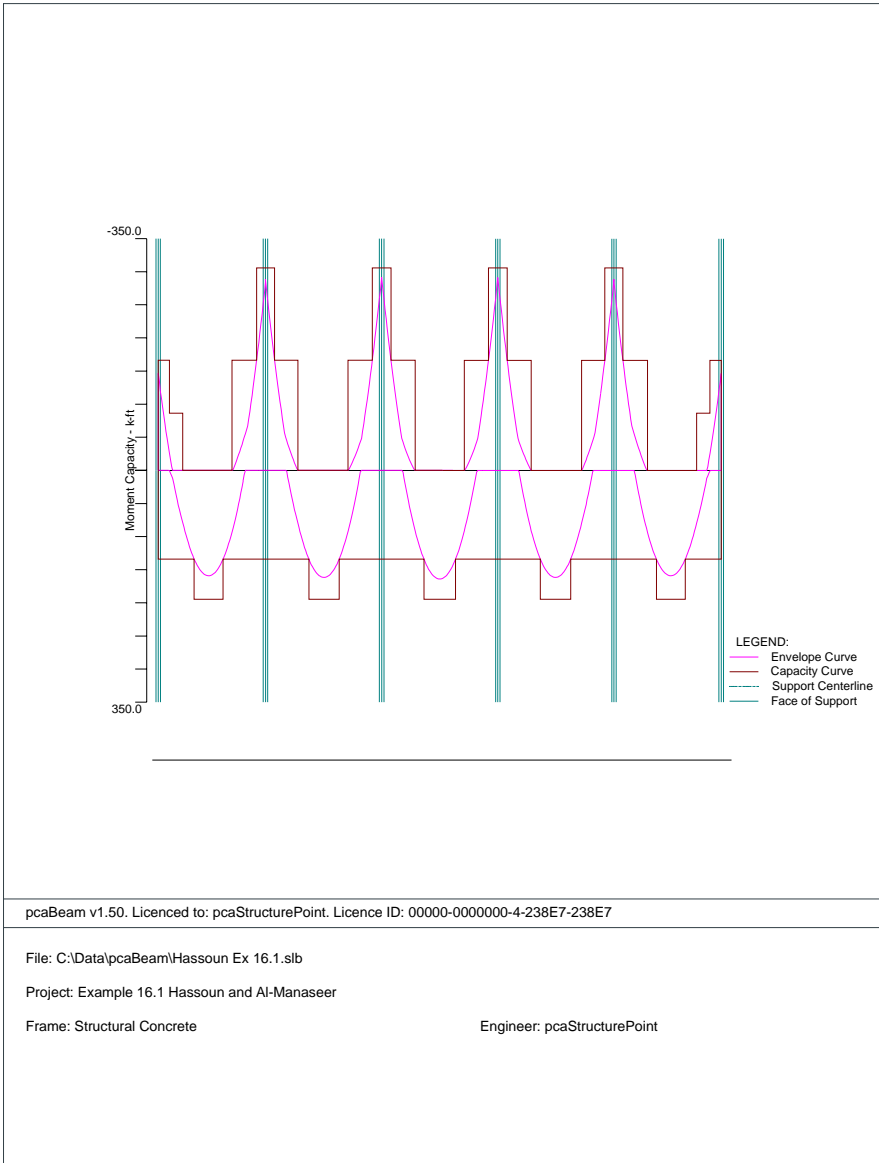

Shear Capacity

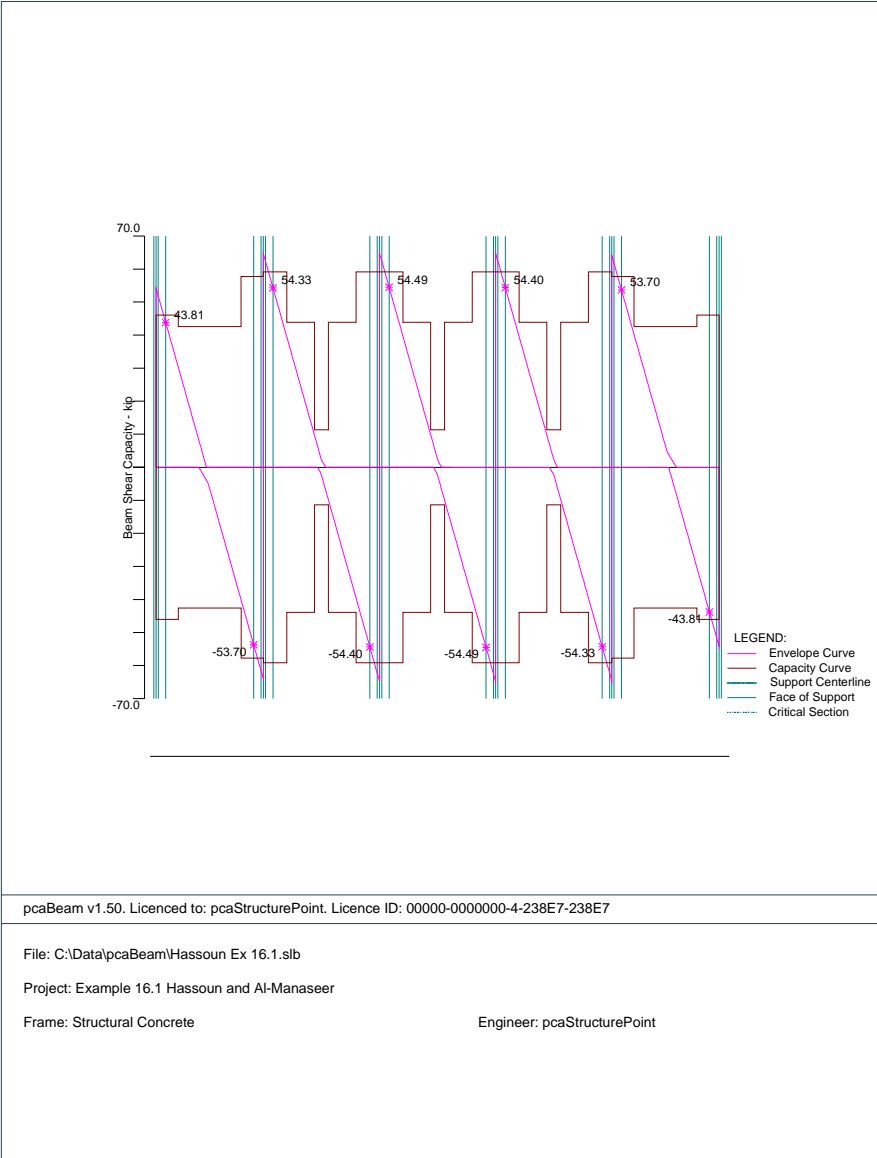

pcaBeam v1.50. Licenced to: pcaStructurePoint. Licence ID: 00000-0000000-4-238E7-238E7

File: C:\Data\pcaBeam\Hassoun Ex 16.1.slb

Project: Example 16.1 Hassoun and Al-Manaseer

Frame: Structural Concrete

Engineer: pcaStructurePoint

Deflection

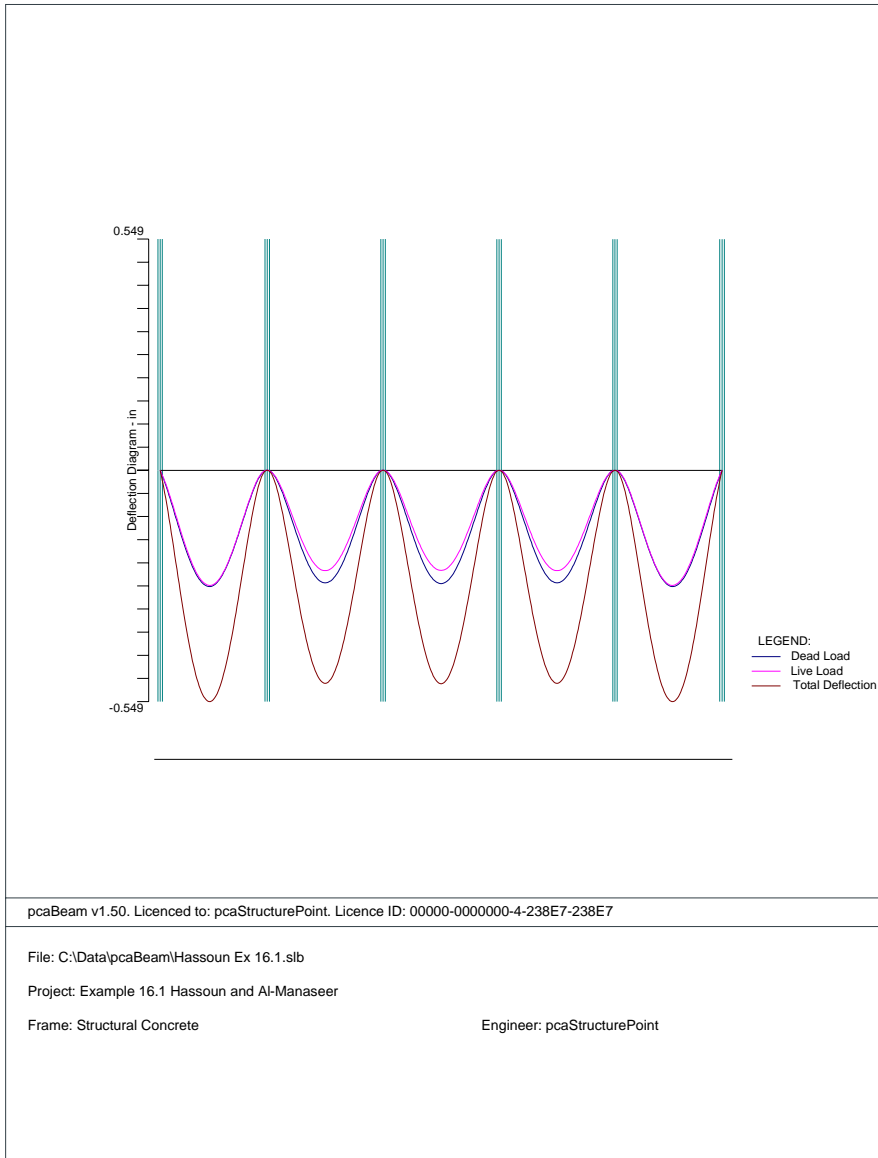

Flexural Rebar

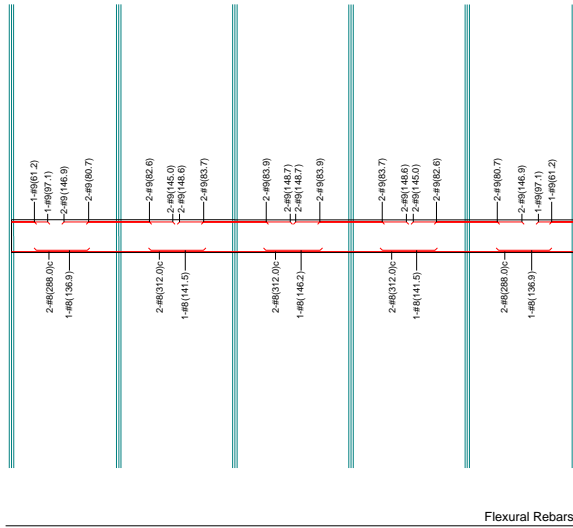

pcaBeam v1.50. Licenced to: pcaStructurePoint. Licence ID: 00000-0000000-4-238E7-238E7

File: C:\Data\pcaBeam\Hassoun Ex 16.1.slb

Project: Example 16.1 Hassoun and Al-Manaseer

Frame: Structural Concrete

Engineer: pcaStructurePoint

Transverse Rebar

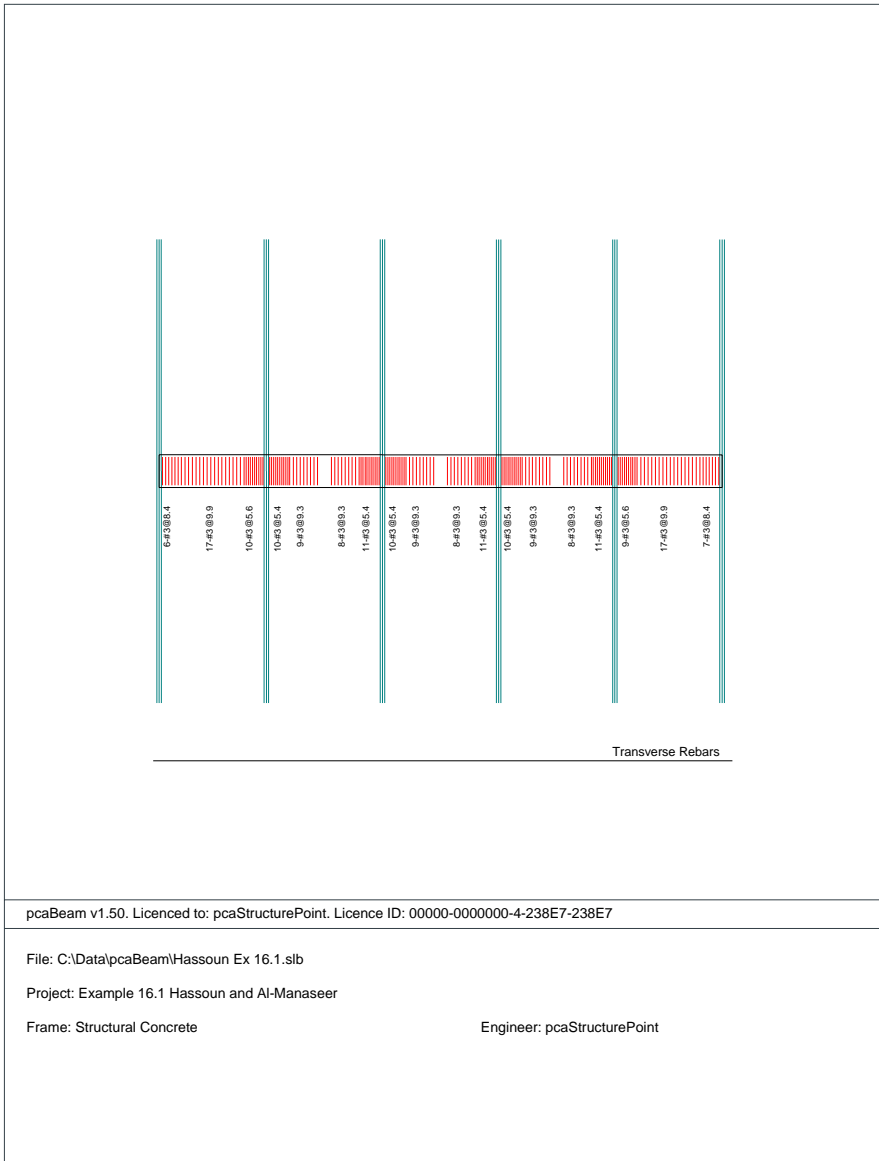

Example 4 Flat Plate Floor System

Problem description

An office building is planned using a flat plate floor system with the column layout as shown in figure below. No beams, drop panels, or column capitals are permitted. Specified live load is 100 psf and dead load will include the weight of the slab plus an allowance of 20 psf for finish floor plus suspended loads. The columns will be 18 in. square, and the floor-to-floor height of the structure will be 12 ft. The slab thickness will be 8.5 in. according to ACI Code. Design the interior panel *C*, using material strengths $f_y = 60,000$ psi and $f'_c = 4000$ psi. Straight-bar reinforcement will be used. This example refers to Example 13-3 from *Design of Concrete Structures* by Nilson, Darwin, and Dolan, Thirteenth Edition, 2004

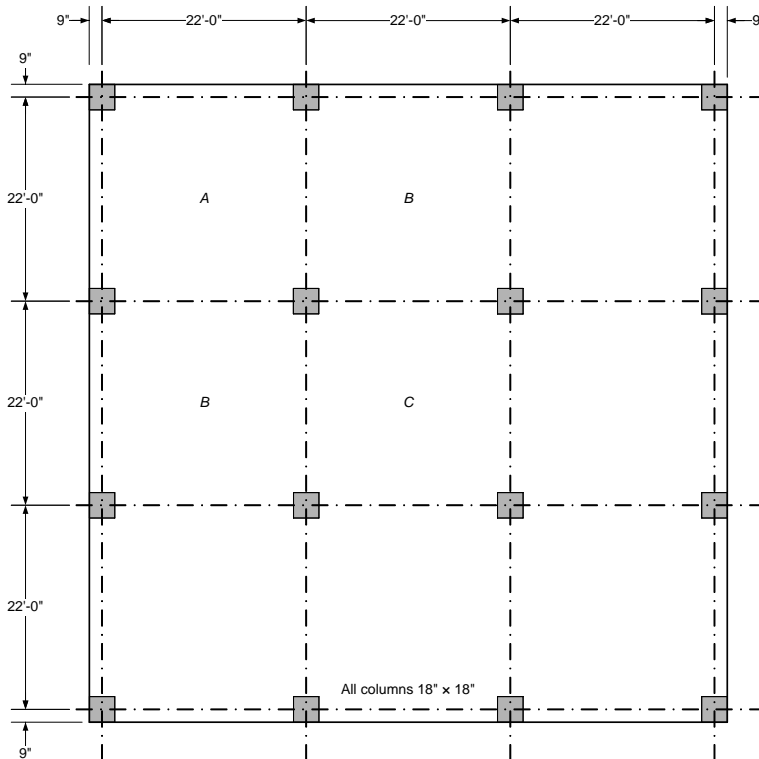

Program Input

1. From the **Input** menu, select **General Information**. A dialog box appears.
 - In the LABELS section, input the names of the project, frame, and engineer.
 - In the FRAME section, input 4 for NO OF SUPPORTS.
 - In the FLOOR SYSTEM section, click the radial button next to TWO-WAY.
 - Leave all other options in the **General Information** tab to their default settings of ACI 318-02 design code, ASTM A615 reinforcement, and DESIGN run mode option.

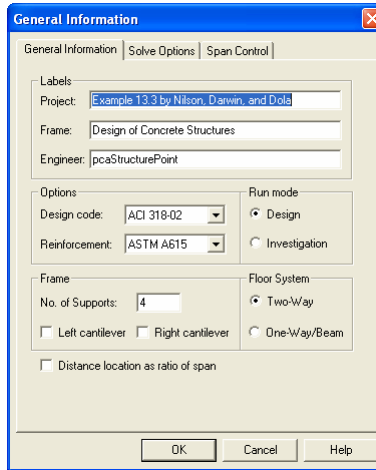

2. Nothing needs to be changed in the **Material Properties** menu.

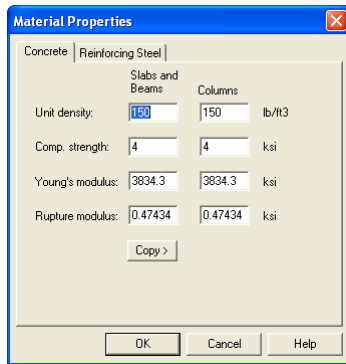

3. From the **Input** menu, select **Spans**. A dialog box appears.
 - Under the **Slabs/Flanges** tab, input 22 for LENGTH, 8.5 for THICKNESS, and 11 for WIDTH LEFT and WIDTH RIGHT. Press MODIFY.
 - Press COPY. Press the CHECK ALL button. Press OK.
 - Press OK again.

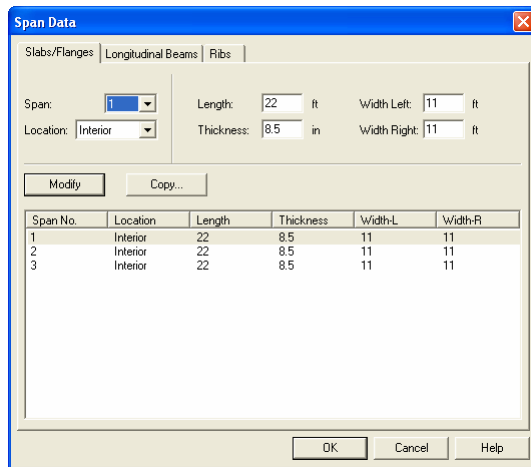

4. From the **Input** menu, select **Supports**. A dialog box appears.
 - Under the **Columns** tab, input 12 for the HEIGHT in both the ABOVE and BELOW rows.

- Input 18 for both the c1 and c2 values in both the ABOVE and BELOW rows. Press MODIFY.
- Press COPY. Press the CHECK ALL button. Press OK.
- Press OK again.

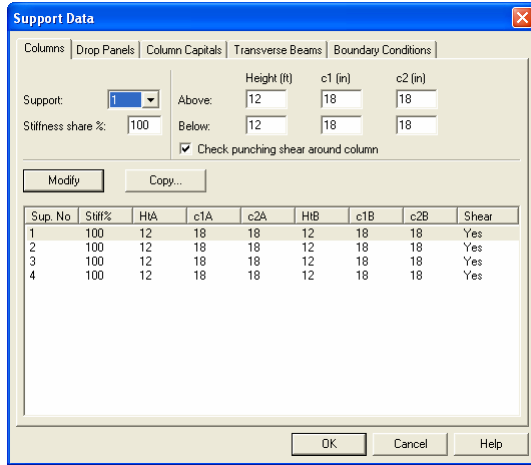

5. From the **Input** menu, select **Reinforcement Criteria**.

- Use the drop down arrow next to MAX BAR SIZE for both TOP BARS and BOTTOM BARS to select #6 bars.
- Press OK.

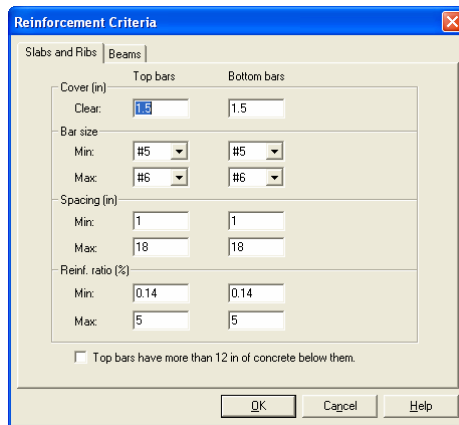

6. From the **Input** menu, select **Load Cases**. A dialog box appears.
 - Since we are not considering lateral forces, click on WIND in the LABEL column on the list in the bottom half of the LOAD CASES dialog box and press the DELETE button.
 - Click on EQ in the LABEL column and press the DELETE button. Press OK.

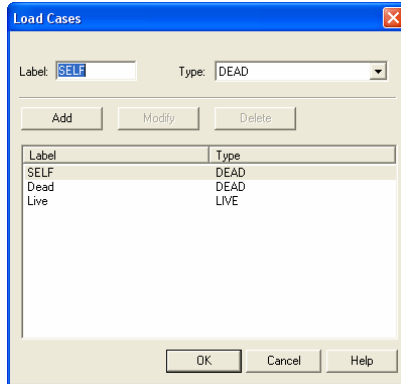

7. From the **Input** menu, select **Load Combinations**. A dialog box appears.
 - Delete all the load combinations by clicking anywhere on the list in the bottom half of the LOAD COMBINATIONS dialog box and pressing the DELETE button. Repeat this procedure until all the load combinations are gone.
 - Input 1 . 2 in the SELF field, 1 . 2 in the DEAD field, and 1 . 6 in the LIVE field. Press ADD.
 - Press OK.

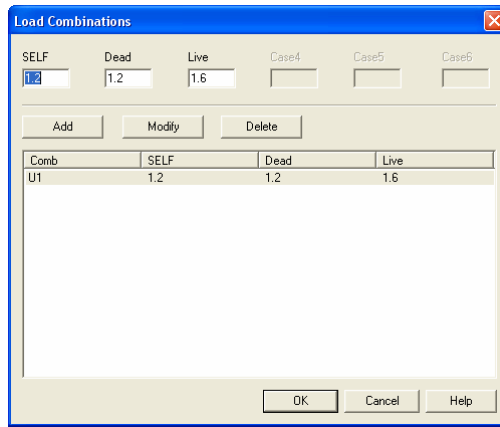

8. From the **Input** menu, select **Span Loads**. A dialog box appears.
 - Input 20 for the **MAGNITUDE**. Press **ADD**.
 - Press **COPY**. Press the **CHECK ALL** button. Press **OK**.
 - In the top left corner of the **SPAN LOADS** dialog box, there is a section called **CURRENT CASE**. Click on **LIVE**.
 - Input 100 for **MAGNITUDE**. Press **ADD**.
 - Press **COPY**. Press the **CHECK ALL** button. Press **OK**.
 - Press **OK** again.

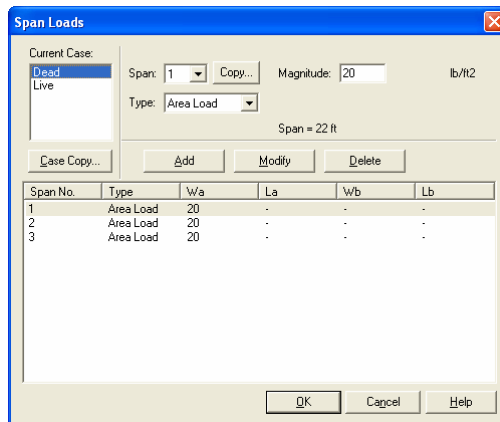

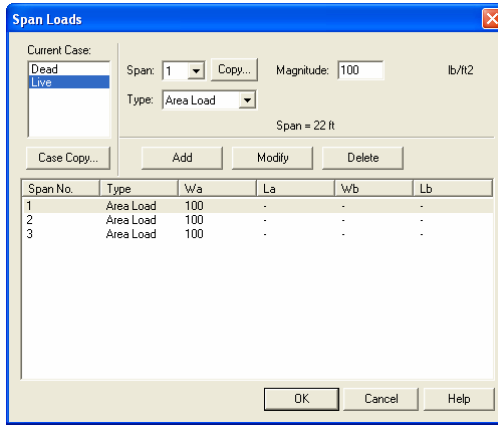

9. From the **Solve** menu, select **Execute**. Press **CLOSE**.
10. From the **Solve** menu, select **Results Report**.
 - Use the scroll bars to scroll through the results file.
 - Use the **ARROW** keys or the mouse wheel to browse through different parts of the results quickly. Press the **CLOSE** button to close the **RESULTS REPORT** dialog box and return to **pcaBeam**.
11. To view diagrams, select **Loads**, **Internal Forces**, **Moment Capacity**, **Shear Capacity**, **Deflection**, or **Reinforcement** from the **View** menu. Right click in any of these diagrams to get new copy, printing, or display options.
12. You may print the results file by selecting **Print Results** from the **File** menu. To print any of the diagrams you selected to view, use the **Print Preview** command found by right clicking in the diagram's window. After viewing the results, you may decide to investigate the input beams under the same loads but with a modified reinforcement configuration.
13. From the **Input** menu, select **General Information**. In the **General Information** dialog box change the **RUN MODE** option to **INVESTIGATION**. Do not change any of the other options. Press **OK**
14. From the **Input** menu, select the different commands under **Reinforcement Criteria** and **Reinforcing Bars** to modify the reinforcement configuration computed by the program.
15. Repeat steps 10 and subsequent to perform the investigation and view the results.

Text Output (abbreviated)

```

oooooooo  oooooo  ooooo
oooooooooo oooooooooo oooooooooo
oo oo oo oo oo oo oo
oo oo oo oo oo oo
oooooooooo oo ooooooo oooooo
oooooooooo oo oo ooooooo oooooo
oo oo oo oo oo oo oo
oo ooooooooo oo oo
oo ooooooo oo oo

```

```

oooooo  o  o
oooooooooo oo ooooo oo
oo oo oo o oo oo
oooo oo o oo oo
oooooooooo oo ooooooo ooooooo
oooooo oo oo oo oo oo
oo oo oo oo oo oo oo
oooooooooo oo o oo oo oo oo
oooooo ooo ooooo o ooooo

```

```

=====
pcaSlab v1.50 (TM)
A Computer Program Analysis, Design, and Investigation of
Reinforced Concrete Slab and Continuous Beam Systems
=====
Copyright © 2000-2005, Portland Cement Association
All rights reserved

```

Licensee stated above acknowledges that Portland Cement Association (PCA) is not and cannot be responsible for either the accuracy or adequacy of the material supplied as input for processing by the pcaSlab computer program. Furthermore, PCA neither makes any warranty expressed nor implied with respect to the correctness of the output prepared by the pcaSlab program. Although PCA has endeavored to produce pcaSlab error free the program is not and cannot be certified infallible. The final and only responsibility for analysis, design and engineering documents is the licensees. Accordingly, PCA disclaims all responsibility in contract, negligence or other tort for any analysis, design or engineering documents prepared in connection with the use of the pcaSlab program.

```

=====
[1] INPUT ECHO
=====

```

General Information:

```

=====
File name: C:\Data\pcaSlab\Nilson Example 13.3.slb
Project: Example 13.3 by Nilson, Darwin, and Dolan
Frame: Design of Concrete Structures Engineer: pcaStructurePoint
Code: ACI 318-02 Mode: Design Reinforcement Database: ASTM A615
Number of supports = 4
Floor System: Two-Way

Live load pattern ratio = 75%
Minimum free edge for punching shear = 10 times slab thickness
Deflections are based on cracked section properties.
In negative moment regions, Igr and Mcr DO NOT include flange/slab contribution (if available)
Compression reinforcement calculations NOT selected.

```

Material Properties:

```

=====
Slabs|Beams Columns

```

```

wc = ----- 150 ----- 150 lb/ft3
f'c = 4 4 ksi
Ec = 3834.25 3834.25 ksi
fr = 0.474342 0.474342 ksi

fy = 60 ksi, Bars are not epoxy-coated
fyv = 60 ksi
Es = 29000 ksi

```

Reinforcement Database:

```

=====
Units: Db (in), Ab (in^2), Wb (lb/ft)
Size Db Ab Wb Size Db Ab Wb
-----
#3 0.38 0.11 0.38 #4 0.50 0.20 0.67
#5 0.63 0.31 1.04 #6 0.75 0.44 1.50
#7 0.88 0.60 2.04 #8 1.00 0.79 2.67
#9 1.13 1.00 3.40 #10 1.27 1.27 4.30
#11 1.41 1.56 5.31 #14 1.69 2.25 7.65
#18 2.26 4.00 13.60

```

Span Data:

```

=====
Slabs: L1, wL, wR (ft); t, Hmin (in)
Span Loc L1 t wL wR Hmin
-----
1 Int 22.000 8.50 11.000 11.000 8.20
2 Int 22.000 8.50 11.000 11.000 7.45
3 Int 22.000 8.50 11.000 11.000 8.20

```

Support Data:

```

=====
Columns: c1a, c2a, c1b, c2b (in); Ha, Hb (ft)
Supp c1a c2a Ha c1b c2b Hb Red%
-----
1 18.00 18.00 12.000 18.00 18.00 12.000 100
2 18.00 18.00 12.000 18.00 18.00 12.000 100
3 18.00 18.00 12.000 18.00 18.00 12.000 100
4 18.00 18.00 12.000 18.00 18.00 12.000 100

```

Boundary Conditions: Kz (kip/in); Kry (kip-in/rad)

```

Supp Spring Kz Spring Kry Far End A Far End B
-----
1 0 0 Fixed Fixed
2 0 0 Fixed Fixed
3 0 0 Fixed Fixed
4 0 0 Fixed Fixed

```

Load Data:

```

=====
Load Cases and Combinations:
Case SELF Dead Live
Type DEAD DEAD LIVE
U1 1.200 1.200 1.600

```

Span Loads:

```

Span Case Wa
-----
Area Loads - Wa (lb/ft2):
1 Dead 20
2 Dead 20
3 Dead 20
1 Live 100
2 Live 100
3 Live 100

```

Support Loads: --- NONE ---

Support Displacements: --- NONE ---

Reinforcement Criteria:

```

=====
                Top bars           Bottom bars           Stirrups
                Min      Max      Min      Max      Min      Max
                -----
Slabs and Ribs:
Bar Size       #5       #6       #5       #6
Bar spacing    1.00    18.00    1.00    18.00 in
Reinf ratio    0.14     5.00    0.14     5.00 %
Cover          1.50           1.50           in
Beams:
Bar Size       #5       #8       #5       #8       #3       #5
Bar spacing    1.00    18.00    1.00    18.00    6.00    18.00 in
Reinf ratio    0.14     5.00    0.14     5.00 %
Cover          1.50           1.50           in
    
```

[2] DESIGN RESULTS

Top Reinforcement:

```

=====
Units: Width (ft), Mmax (k-ft), Xmax (ft), As (in^2), Sp (in)
Span Strip Zone      Width      Mmax      Xmax      AsMin      AsMax      SpReq      AsReq      Bars
-----
1 Column Left  11.00      21.63     0.750     2.020     15.945     16.500     0.724     8-#5 *5
   Middle     11.00         0.00     11.000     0.000     15.945     0.000     0.000     ---
   Right     11.00     211.61     21.250     2.020     15.945     5.280     7.610     25-#5
   Middle Left 11.00      -0.00     0.750     2.020     15.945     16.500     0.000     8-#5 *5
   Middle     11.00         0.00     11.000     0.000     15.945     0.000     0.000     ---
   Right     11.00     70.54     21.250     2.020     15.945     16.500     2.402     8-#5
2 Column Left  11.00     188.13     0.750     2.020     15.945     5.280     6.700     25-#5
   Middle     11.00         0.17     7.925     2.020     15.945     16.500     0.006     8-#5 *5
   Right     11.00     188.13     21.250     2.020     15.945     5.280     6.700     25-#5
   Middle Left 11.00         62.71     0.750     2.020     15.945     16.500     2.129     8-#5 *5
   Middle     11.00         0.06     7.925     2.020     15.945     16.500     0.002     8-#5 *5
   Right     11.00         62.71     21.250     2.020     15.945     16.500     2.129     8-#5 *5
3 Column Left  11.00     211.61     0.750     2.020     15.945     5.280     7.610     25-#5
   Middle     11.00         0.00     11.000     0.000     15.945     0.000     0.000     ---
   Right     11.00         21.63     21.250     2.020     15.945     16.500     0.724     8-#5 *5
   Middle Left 11.00         70.54     0.750     2.020     15.945     16.500     2.402     8-#5
   Middle     11.00         0.00     11.000     0.000     15.945     0.000     0.000     ---
   Right     11.00        -0.00     21.250     2.020     15.945     16.500     0.000     8-#5 *5
    
```

NOTES:

*5 - Number of bars governed by maximum allowable spacing.

Top Bar Details:

```

=====
Units: Length (ft)
                Left                Continuous                Right
Span Strip     Bars Length Bars Length Bars Length Bars Length Bars Length
-----
1 Column 7-#5 7.52 1-#5 4.85 --- --- 13-#5 7.53 12-#5 4.85
   Middle 8-#5 5.26 --- --- 8-#5 7.53 --- ---
2 Column 9-#5 7.52 8-#5 4.85 8-#5 22.00 9-#5 7.52 8-#5 4.85
   Middle --- --- 8-#5 22.00 --- ---
3 Column 13-#5 7.53 12-#5 4.85 --- --- 7-#5 7.52 1-#5 4.85
   Middle 8-#5 7.53 --- --- 8-#5 5.26 --- ---
    
```

Bottom Reinforcement:

=====

Units: Width (ft), Mmax (k-ft), Xmax (ft), As (in²), Sp (in)

Span Strip	Width	Mmax	Xmax	AsMin	AsMax	SpReq	AsReq	Bars
1 Column	11.00	132.42	9.250	2.020	15.945	8.800	4.613	15-#5
Middle	11.00	88.28	9.250	2.020	15.945	13.200	3.025	10-#5
2 Column	11.00	78.82	11.000	2.020	15.945	14.667	2.692	9-#5
Middle	11.00	52.55	11.000	2.020	15.945	16.500	1.778	8-#5 *5
3 Column	11.00	132.42	12.750	2.020	15.945	8.800	4.613	15-#5
Middle	11.00	88.28	12.750	2.020	15.945	13.200	3.025	10-#5

NOTES:

*5 - Number of bars governed by maximum allowable spacing.

Bottom Bar Details:

=====

Units: Start (ft), Length (ft)

Span Strip	Long Bars			Short Bars		
	Bars	Start	Length	Bars	Start	Length
1 Column	15-#5	0.00	22.00	---		
Middle	7-#5	0.00	22.00	3-#5	3.30	15.40
2 Column	9-#5	0.00	22.00	---		
Middle	7-#5	0.00	22.00	1-#5	3.30	15.40
3 Column	15-#5	0.00	22.00	---		
Middle	7-#5	0.00	22.00	3-#5	3.30	15.40

Flexural Capacity:

=====

Units: From, To (ft), As (in²), PhiMn (k-ft)

Span Strip	From	To	AsTop	AsBot	PhiMn-	PhiMn+	
1 Column	0.000	0.750	2.48	4.65	-72.78	133.43	
	0.750	3.851	2.48	4.65	-72.78	133.43	
	3.851	4.851	2.17	4.65	-63.89	133.43	
	4.851	6.515	2.17	4.65	-63.89	133.43	
	6.515	7.515	0.00	4.65	0.00	133.43	
	7.515	7.925	0.00	4.65	0.00	133.43	
	7.925	11.000	0.00	4.65	0.00	133.43	
	11.000	14.075	0.00	4.65	0.00	133.43	
	14.075	14.469	0.00	4.65	0.00	133.43	
	14.469	15.633	0.00	4.65	0.00	133.43	
	15.633	17.149	4.03	4.65	-116.39	133.43	
	17.149	18.314	4.03	4.65	-116.39	133.43	
	18.314	21.250	7.75	4.65	-215.16	133.43	
	21.250	22.000	7.75	4.65	-215.16	133.43	
	Middle	0.000	0.750	2.48	2.17	-72.78	63.89
		0.750	3.300	2.48	2.17	-72.78	63.89
		3.300	4.261	2.48	2.17	-72.78	63.89
		4.261	4.457	0.00	2.17	0.00	63.89
		4.457	5.261	0.00	3.10	0.00	90.40
		5.261	7.925	0.00	3.10	0.00	90.40
7.925		11.000	0.00	3.10	0.00	90.40	
11.000		14.075	0.00	3.10	0.00	90.40	
14.075		14.469	0.00	3.10	0.00	90.40	
14.469		15.617	0.00	3.10	0.00	90.40	
15.617		17.543	2.48	3.10	-72.78	90.40	
17.543		18.700	2.48	2.17	-72.78	63.89	
18.700		21.250	2.48	2.17	-72.78	63.89	
21.250	22.000	2.48	2.17	-72.78	63.89		
2 Column	0.000	0.750	7.75	2.79	-215.16	81.62	
	0.750	3.825	7.75	2.79	-215.16	81.62	
	3.825	4.851	5.27	2.79	-150.24	81.62	

	4.851	6.490	5.27	2.79	-150.24	81.62
	6.490	7.515	2.48	2.79	-72.78	81.62
	7.515	7.925	2.48	2.79	-72.78	81.62
	7.925	11.000	2.48	2.79	-72.78	81.62
	11.000	14.075	2.48	2.79	-72.78	81.62
	14.075	14.485	2.48	2.79	-72.78	81.62
	14.485	15.510	2.48	2.79	-72.78	81.62
	15.510	17.149	5.27	2.79	-150.24	81.62
	17.149	18.175	5.27	2.79	-150.24	81.62
	18.175	21.250	7.75	2.79	-215.16	81.62
	21.250	22.000	7.75	2.79	-215.16	81.62
Middle	0.000	0.750	2.48	2.17	-72.78	63.89
	0.750	3.300	2.48	2.17	-72.78	63.89
	3.300	4.300	2.48	2.17	-72.78	63.89
	4.300	7.925	2.48	2.48	-72.78	72.78
	7.925	11.000	2.48	2.48	-72.78	72.78
	11.000	14.075	2.48	2.48	-72.78	72.78
	14.075	17.700	2.48	2.48	-72.78	72.78
	17.700	18.700	2.48	2.17	-72.78	63.89
	18.700	21.250	2.48	2.17	-72.78	63.89
	21.250	22.000	2.48	2.17	-72.78	63.89
3 Column	0.000	0.750	7.75	4.65	-215.16	133.43
	0.750	3.686	7.75	4.65	-215.16	133.43
	3.686	4.851	4.03	4.65	-116.39	133.43
	4.851	6.367	4.03	4.65	-116.39	133.43
	6.367	7.531	0.00	4.65	0.00	133.43
	7.531	7.925	0.00	4.65	0.00	133.43
	7.925	11.000	0.00	4.65	0.00	133.43
	11.000	14.075	0.00	4.65	0.00	133.43
	14.075	14.485	0.00	4.65	0.00	133.43
	14.485	15.485	0.00	4.65	0.00	133.43
	15.485	17.149	2.17	4.65	-63.89	133.43
	17.149	18.149	2.17	4.65	-63.89	133.43
	18.149	21.250	2.48	4.65	-72.78	133.43
	21.250	22.000	2.48	4.65	-72.78	133.43
Middle	0.000	0.750	2.48	2.17	-72.78	63.89
	0.750	3.300	2.48	2.17	-72.78	63.89
	3.300	4.457	2.48	2.17	-72.78	63.89
	4.457	6.383	2.48	3.10	-72.78	90.40
	6.383	7.531	0.00	3.10	0.00	90.40
	7.531	7.925	0.00	3.10	0.00	90.40
	7.925	11.000	0.00	3.10	0.00	90.40
	11.000	14.075	0.00	3.10	0.00	90.40
	14.075	16.739	0.00	3.10	0.00	90.40
	16.739	17.543	0.00	3.10	0.00	90.40
	17.543	17.739	0.00	2.17	0.00	63.89
	17.739	18.700	2.48	2.17	-72.78	63.89
	18.700	21.250	2.48	2.17	-72.78	63.89
	21.250	22.000	2.48	2.17	-72.78	63.89

Slab Shear Capacity:

Units: b, d (in), Xu (ft), PhiVc, Vu(kip)						
Span	b	d	Vratio	PhiVc	Vu	Xu
1	264.00	6.69	1.000	167.49	79.20	20.69
2	264.00	6.69	1.000	167.49	66.42	1.31
3	264.00	6.69	1.000	167.49	79.20	1.31

Flexural Transfer of Negative Unbalanced Moment at Supports:

Units: Width (in), Munb (k-ft), As (in ²)							
Supp	Width	GammaF*Munb	Comb	Pat	AsReq	AsProv	Additional Bars
1	43.50	44.32	U1	All	1.545	0.817	3-#5
2	43.50	45.11	U1	Odd	1.574	2.554	---
3	43.50	45.11	U1	Odd	1.574	2.554	---

4 43.50 44.32 U1 All 1.545 0.817 3-#5

Punching Shear Around Columns:

```

=====
Units: Vu (kip), Munb (k-ft), vu (psi), Phi*vc (psi)
Supp Vu vu Munb Comb Pat GammaV vu Phi*vc
-----
1 61.95 177.9 20.55 U1 All 0.320 216.4 189.7 *EXCEEDED
2 162.23 248.6 -40.89 U1 All 0.400 284.6 189.7 *EXCEEDED
3 162.23 248.6 40.89 U1 All 0.400 284.6 189.7 *EXCEEDED
4 61.95 189.9 -17.54 U1 All 0.320 226.0 189.7 *EXCEEDED
  
```

Maximum Deflections:

```

=====
Units: Dz (in)
Span Frame Column Strip Middle Strip
Dz(DEAD) Dz(LIVE) Dz(TOTAL) Dz(DEAD) Dz(LIVE) Dz(TOTAL) Dz(DEAD) Dz(LIVE) Dz(TOTAL)
-----
1 -0.122 -0.185 -0.306 -0.180 -0.272 -0.452 -0.064 -0.097 -0.161
2 -0.032 -0.057 -0.089 -0.044 -0.076 -0.120 -0.021 -0.037 -0.058
3 -0.122 -0.185 -0.306 -0.180 -0.272 -0.452 -0.064 -0.097 -0.161
  
```

Material Takeoff:

```

=====
Reinforcement in the Direction of Analysis
Top Bars: 1248.2 lb <=> 18.91 lb/ft <=> 0.860 lb/ft^2
Bottom Bars: 1489.2 lb <=> 22.56 lb/ft <=> 1.026 lb/ft^2
Stirrups: 0.0 lb <=> 0.00 lb/ft <=> 0.000 lb/ft^2
Total Steel: 2737.3 lb <=> 41.47 lb/ft <=> 1.885 lb/ft^2
Concrete: 1028.5 ft^3 <=> 15.58 ft^3/ft <=> 0.708 ft^3/ft^2
  
```

[3] COLUMN AXIAL FORCES AND MOMENTS

```

=====
Units: P (kip), M (k-ft)
Supp Case/Patt P (axial) Mb[top] Ma[bottom]
-----
1 SELF 21.35 -11.12 -11.12
  Dead 4.02 -2.09 -2.09
  Live/All 20.10 -10.47 -10.47
  Live/Odd 16.42 -9.62 -9.62
  Live/Even -1.35 1.77 1.77
  Live/S1 16.11 -9.21 -9.21
  Live/S2 14.76 -7.44 -7.44
  Live/S3 -1.04 1.36 1.36
  Live/S4 0.31 -0.41 -0.41
2 SELF 55.78 6.97 6.97
  Dead 10.50 1.31 1.31
  Live/All 52.50 6.56 6.56
  Live/Odd 19.88 17.28 17.28
  Live/Even 19.50 -12.36 -12.36
  Live/S1 22.29 14.42 14.42
  Live/S2 41.79 2.06 2.06
  Live/S3 17.09 -9.50 -9.50
  Live/S4 -2.41 2.86 2.86
3 SELF 55.78 -6.97 -6.97
  Dead 10.50 -1.31 -1.31
  Live/All 52.50 -6.56 -6.56
  Live/Odd 19.88 -17.28 -17.28
  Live/Even 19.50 12.36 12.36
  Live/S1 -2.41 -2.86 -2.86
  Live/S2 17.09 9.50 9.50
  
```

	Live/S3	41.79	-2.06	-2.06
	Live/S4	22.29	-14.42	-14.42
4	SELF	21.35	11.12	11.12
	Dead	4.02	2.09	2.09
	Live/All	20.10	10.47	10.47
	Live/Odd	16.42	9.62	9.62
	Live/Even	-1.35	-1.77	-1.77
	Live/S1	0.31	0.41	0.41
	Live/S2	-1.04	-1.36	-1.36
	Live/S3	14.76	7.44	7.44
	Live/S4	16.11	9.21	9.21
Sum	SELF	154.28	0.00	0.00
	Dead	29.04	0.00	0.00
	Live/All	145.20	0.00	0.00
	Live/Odd	72.60	0.00	0.00
	Live/Even	36.30	-0.00	-0.00
	Live/S1	36.30	2.76	2.76
	Live/S2	72.60	2.76	2.76
	Live/S3	72.60	-2.76	-2.76
	Live/S4	36.30	-2.76	-2.76

=====

[6] SEGMENTAL MOMENT AND SHEAR - ENVELOPES

=====

Span	x (ft)	M- (k-ft)	Comb	M+ (k-ft)	Comb	V- (kip)	Comb	V+ (kip)	Comb
1	0.000	-65.21	U1	0.00	U1	0.00	U1	62.60	U1
	0.250	-49.78	U1	0.00	U1	0.00	U1	60.89	U1
	0.500	-34.88	U1	0.00	U1	0.00	U1	59.18	U1
	0.750	-21.63	U1	0.00	U1	0.00	U1	57.46	U1
	0.750	-21.63	U1	0.00	U1	0.00	U1	57.46	U1
	1.000	-8.76	U1	0.56	U1	0.00	U1	55.75	U1
	1.250	0.00	U1	7.69	U1	0.00	U1	54.04	U1
	1.500	0.00	U1	20.98	U1	0.00	U1	52.33	U1
	1.750	0.00	U1	33.85	U1	0.00	U1	50.61	U1
	2.000	0.00	U1	46.29	U1	0.00	U1	48.90	U1
	2.250	0.00	U1	58.30	U1	0.00	U1	47.19	U1
	2.500	0.00	U1	69.88	U1	0.00	U1	45.47	U1
	2.750	0.00	U1	81.04	U1	0.00	U1	43.76	U1
	3.000	0.00	U1	91.76	U1	0.00	U1	42.05	U1
	3.250	0.00	U1	102.06	U1	0.00	U1	40.33	U1
	3.500	0.00	U1	111.93	U1	0.00	U1	38.62	U1
	3.750	0.00	U1	121.37	U1	0.00	U1	36.91	U1
	4.000	0.00	U1	130.38	U1	0.00	U1	35.19	U1
	4.250	0.00	U1	138.96	U1	0.00	U1	33.48	U1
	4.500	0.00	U1	147.12	U1	0.00	U1	31.77	U1
	4.750	0.00	U1	154.85	U1	0.00	U1	30.05	U1
	5.000	0.00	U1	162.15	U1	0.00	U1	28.34	U1
	5.250	0.00	U1	169.02	U1	0.00	U1	26.63	U1
	5.500	0.00	U1	175.46	U1	0.00	U1	24.91	U1
	5.750	0.00	U1	181.47	U1	0.00	U1	23.20	U1
	6.000	0.00	U1	187.06	U1	0.00	U1	21.49	U1
	6.250	0.00	U1	192.22	U1	0.00	U1	19.77	U1
	6.500	0.00	U1	196.95	U1	0.00	U1	18.06	U1
	6.750	0.00	U1	201.25	U1	0.00	U1	16.41	U1
	7.000	0.00	U1	205.12	U1	0.00	U1	14.92	U1
	7.250	0.00	U1	208.56	U1	0.00	U1	13.42	U1
	7.500	0.00	U1	211.58	U1	0.00	U1	11.93	U1
	7.750	0.00	U1	214.17	U1	0.00	U1	10.44	U1
	8.000	0.00	U1	216.33	U1	0.00	U1	8.94	U1
	8.250	0.00	U1	218.06	U1	0.00	U1	7.45	U1
	8.500	0.00	U1	219.36	U1	-0.04	U1	5.96	U1
	8.750	0.00	U1	220.23	U1	-0.88	U1	4.46	U1
	9.000	0.00	U1	220.68	U1	-1.71	U1	2.97	U1

9.250	0.00 U1	220.70 U1	-2.54 U1	1.48 U1
9.500	0.00 U1	220.29 U1	-3.38 U1	0.00 U1
9.750	0.00 U1	219.45 U1	-4.21 U1	0.00 U1
10.000	0.00 U1	218.18 U1	-5.93 U1	0.00 U1
10.250	0.00 U1	216.49 U1	-7.64 U1	0.00 U1
10.500	0.00 U1	214.36 U1	-9.35 U1	0.00 U1
10.750	0.00 U1	211.81 U1	-11.07 U1	0.00 U1
11.000	0.00 U1	208.83 U1	-12.78 U1	0.00 U1
11.250	0.00 U1	205.42 U1	-14.49 U1	0.00 U1
11.500	0.00 U1	201.58 U1	-16.20 U1	0.00 U1
11.750	0.00 U1	197.32 U1	-17.92 U1	0.00 U1
12.000	0.00 U1	192.63 U1	-19.63 U1	0.00 U1
12.250	0.00 U1	187.50 U1	-21.34 U1	0.00 U1
12.500	0.00 U1	181.95 U1	-23.06 U1	0.00 U1
12.750	0.00 U1	175.97 U1	-24.77 U1	0.00 U1
13.000	0.00 U1	170.23 U1	-26.48 U1	0.00 U1
13.250	0.00 U1	164.82 U1	-28.20 U1	0.00 U1
13.500	0.00 U1	159.02 U1	-29.91 U1	0.00 U1
13.750	0.00 U1	152.86 U1	-31.62 U1	0.00 U1
14.000	0.00 U1	146.32 U1	-33.34 U1	0.00 U1
14.250	0.00 U1	139.41 U1	-35.05 U1	0.00 U1
14.500	0.00 U1	132.13 U1	-36.76 U1	0.00 U1
14.750	0.00 U1	124.47 U1	-38.48 U1	0.00 U1
15.000	0.00 U1	116.44 U1	-40.19 U1	0.00 U1
15.250	0.00 U1	108.04 U1	-41.90 U1	0.00 U1
15.500	0.00 U1	99.26 U1	-43.62 U1	0.00 U1
15.750	0.00 U1	90.11 U1	-45.33 U1	0.00 U1
16.000	-0.09 U1	80.59 U1	-47.04 U1	0.00 U1
16.250	-6.46 U1	70.69 U1	-48.76 U1	0.00 U1
16.500	-13.03 U1	60.42 U1	-50.47 U1	0.00 U1
16.750	-19.81 U1	49.78 U1	-52.18 U1	0.00 U1
17.000	-26.80 U1	38.76 U1	-53.90 U1	0.00 U1
17.250	-34.00 U1	27.37 U1	-55.61 U1	0.00 U1
17.500	-41.41 U1	15.61 U1	-57.32 U1	0.00 U1
17.750	-49.02 U1	3.47 U1	-59.04 U1	0.00 U1
18.000	-56.84 U1	0.00 U1	-60.75 U1	0.00 U1
18.250	-64.87 U1	0.00 U1	-62.46 U1	0.00 U1
18.500	-79.75 U1	0.00 U1	-64.18 U1	0.00 U1
18.750	-96.01 U1	0.00 U1	-65.89 U1	0.00 U1
19.000	-112.69 U1	0.00 U1	-67.60 U1	0.00 U1
19.250	-129.81 U1	0.00 U1	-69.32 U1	0.00 U1
19.500	-147.35 U1	0.00 U1	-71.03 U1	0.00 U1
19.750	-165.32 U1	0.00 U1	-72.74 U1	0.00 U1
20.000	-183.72 U1	0.00 U1	-74.46 U1	0.00 U1
20.250	-202.55 U1	0.00 U1	-76.17 U1	0.00 U1
20.500	-221.81 U1	0.00 U1	-77.88 U1	0.00 U1
20.750	-241.49 U1	0.00 U1	-79.60 U1	0.00 U1
21.000	-261.60 U1	0.00 U1	-81.31 U1	0.00 U1
21.250	-282.15 U1	0.00 U1	-83.02 U1	0.00 U1
21.250	-282.15 U1	0.00 U1	-83.02 U1	0.00 U1
21.500	-303.11 U1	0.00 U1	-84.73 U1	0.00 U1
21.750	-324.51 U1	0.00 U1	-86.45 U1	0.00 U1
22.000	-346.34 U1	0.00 U1	-88.16 U1	0.00 U1

=====
 [7] SEGMENTAL DEFLECTIONS
 =====

Units: x (ft), Dz (in)

Span	x	Dz (DEAD)	Dz (LIVE)	Dz (TOTAL)
1	0.000	-0.000	-0.000	-0.000
	0.250	-0.005	-0.007	-0.011
	0.500	-0.009	-0.013	-0.022
	0.750	-0.014	-0.020	-0.034
	0.750	-0.014	-0.020	-0.034
	1.000	-0.019	-0.026	-0.045
	1.250	-0.023	-0.033	-0.057

1.500	-0.028	-0.040	-0.068
1.750	-0.033	-0.047	-0.080
2.000	-0.037	-0.054	-0.091
2.250	-0.042	-0.061	-0.102
2.500	-0.046	-0.068	-0.114
2.750	-0.051	-0.074	-0.125
3.000	-0.055	-0.081	-0.136
3.250	-0.060	-0.088	-0.147
3.500	-0.064	-0.094	-0.158
3.750	-0.068	-0.100	-0.168
4.000	-0.072	-0.107	-0.179
4.250	-0.076	-0.113	-0.189
4.500	-0.080	-0.119	-0.198
4.750	-0.083	-0.124	-0.208
5.000	-0.087	-0.130	-0.217
5.250	-0.090	-0.135	-0.225
5.500	-0.094	-0.140	-0.234
5.750	-0.097	-0.145	-0.242
6.000	-0.100	-0.150	-0.249
6.250	-0.102	-0.154	-0.256
6.500	-0.105	-0.158	-0.263
6.750	-0.107	-0.162	-0.269
7.000	-0.110	-0.165	-0.275
7.250	-0.112	-0.169	-0.280
7.500	-0.114	-0.172	-0.285
7.750	-0.115	-0.174	-0.290
8.000	-0.117	-0.177	-0.293
8.250	-0.118	-0.179	-0.297
8.500	-0.119	-0.181	-0.300
8.750	-0.120	-0.182	-0.302
9.000	-0.121	-0.183	-0.304
9.250	-0.121	-0.184	-0.305
9.500	-0.122	-0.184	-0.306
9.750	-0.122	-0.185	-0.306
10.000	-0.122	-0.184	-0.306
10.250	-0.121	-0.184	-0.305
10.500	-0.121	-0.183	-0.304
10.750	-0.120	-0.182	-0.303
11.000	-0.120	-0.181	-0.300
11.250	-0.119	-0.179	-0.298
11.500	-0.117	-0.177	-0.294
11.750	-0.116	-0.175	-0.291
12.000	-0.114	-0.172	-0.287
12.250	-0.113	-0.170	-0.282
12.500	-0.111	-0.167	-0.277
12.750	-0.109	-0.163	-0.272
13.000	-0.107	-0.160	-0.266
13.250	-0.104	-0.156	-0.260
13.500	-0.102	-0.152	-0.253
13.750	-0.099	-0.147	-0.247
14.000	-0.096	-0.143	-0.239
14.250	-0.093	-0.138	-0.232
14.500	-0.090	-0.133	-0.224
14.750	-0.087	-0.128	-0.216
15.000	-0.084	-0.123	-0.207
15.250	-0.081	-0.118	-0.199
15.500	-0.077	-0.113	-0.190
15.750	-0.074	-0.107	-0.181
16.000	-0.070	-0.102	-0.172
16.250	-0.067	-0.096	-0.163
16.500	-0.063	-0.090	-0.153
16.750	-0.060	-0.084	-0.144
17.000	-0.056	-0.079	-0.135
17.250	-0.052	-0.073	-0.125
17.500	-0.049	-0.067	-0.116
17.750	-0.045	-0.062	-0.107
18.000	-0.041	-0.056	-0.098
18.250	-0.038	-0.051	-0.089

18.500	-0.034	-0.046	-0.080
18.750	-0.031	-0.041	-0.071
19.000	-0.028	-0.036	-0.063
19.250	-0.024	-0.031	-0.055
19.500	-0.021	-0.026	-0.048
19.750	-0.018	-0.022	-0.040
20.000	-0.015	-0.018	-0.034
20.250	-0.013	-0.015	-0.027
20.500	-0.010	-0.012	-0.022
20.750	-0.008	-0.009	-0.017
21.000	-0.006	-0.006	-0.012
21.250	-0.004	-0.004	-0.008
21.250	-0.004	-0.004	-0.008
21.500	-0.003	-0.003	-0.005
21.750	-0.001	-0.001	-0.002
22.000	-0.000	-0.000	-0.000

Graphical Output

Loads

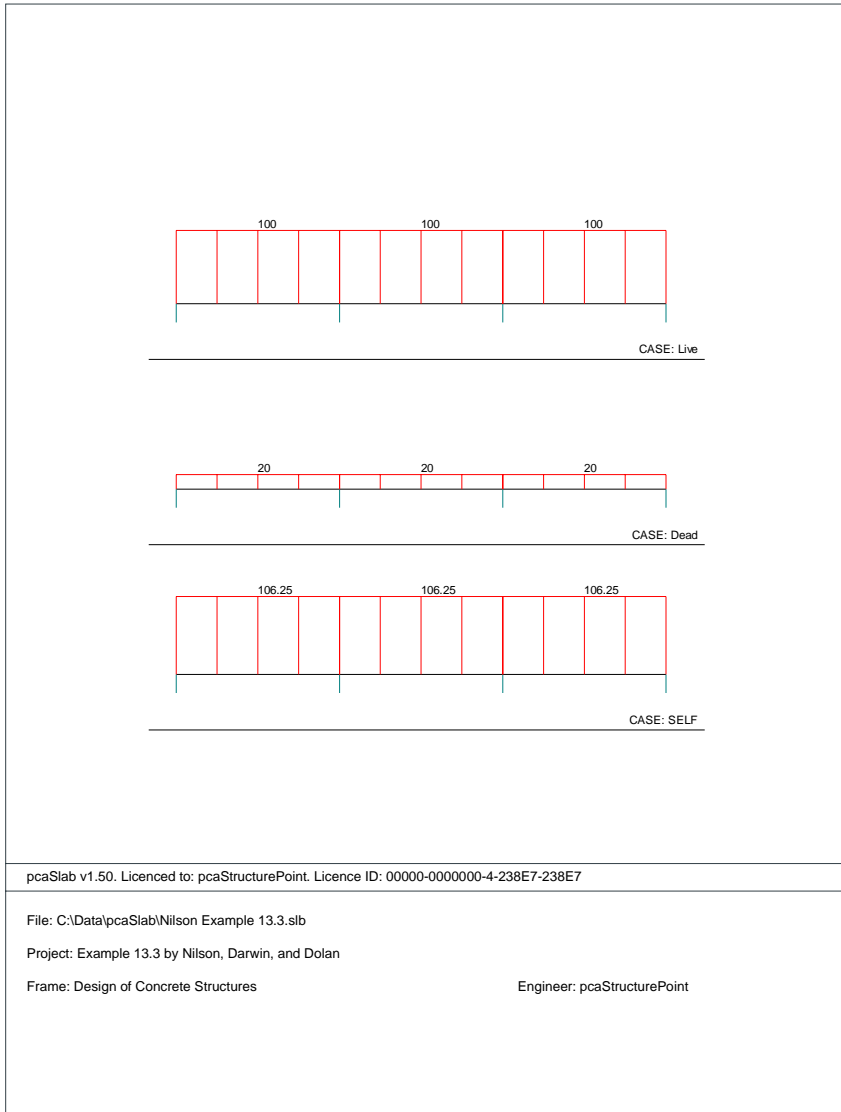

Internal Forces

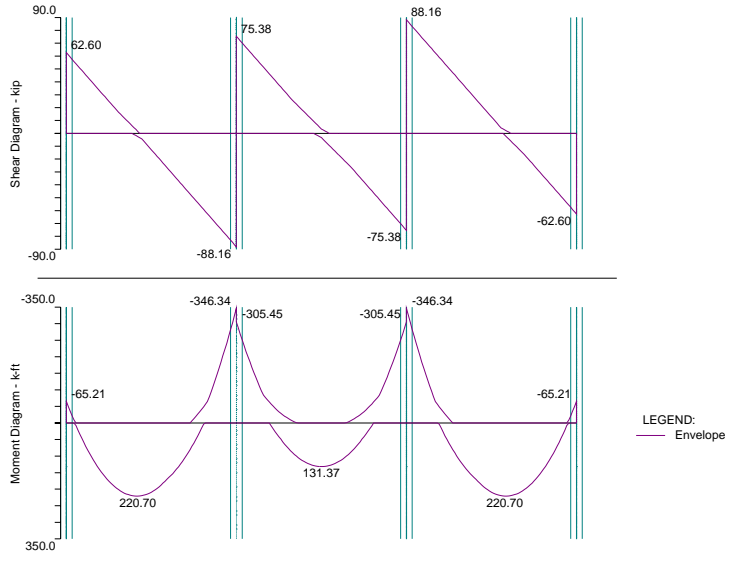

pcaSlab v1.50. Licenced to: pcaStructurePoint. Licence ID: 00000-0000000-4-238E7-238E7

File: C:\Data\pcaSlab\Nilson Example 13.3.slb

Project: Example 13.3 by Nilson, Darwin, and Dolan

Frame: Design of Concrete Structures

Engineer: pcaStructurePoint

Moment Capacity

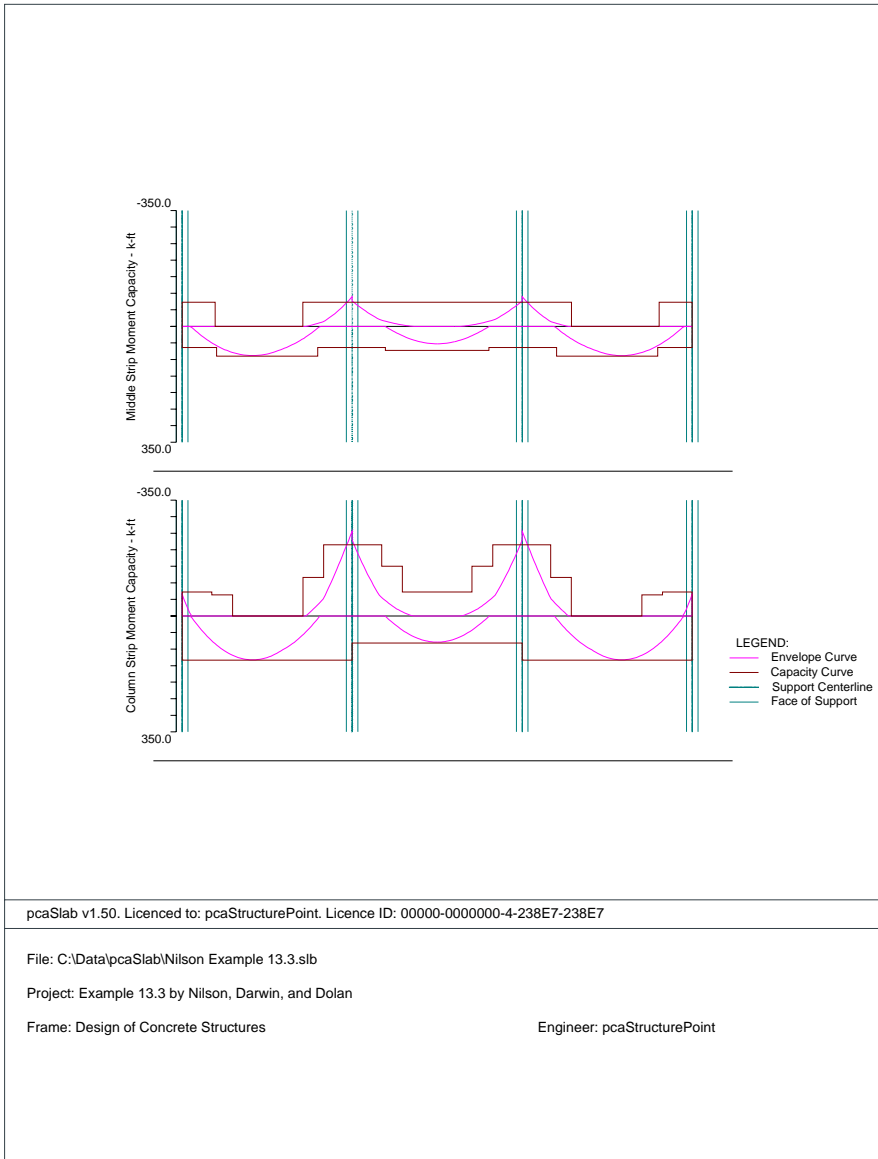

Shear Capacity

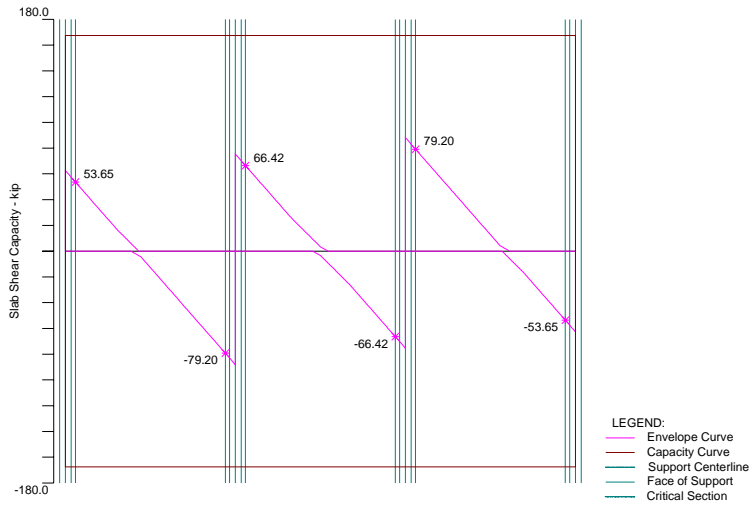

pcaSlab v1.50. Licenced to: pcaStructurePoint. Licence ID: 00000-0000000-4-238E7-238E7

File: C:\Data\pcaSlab\Nilson Example 13.3.slb

Project: Example 13.3 by Nilson, Darwin, and Dolan

Frame: Design of Concrete Structures

Engineer: pcaStructurePoint

Deflection

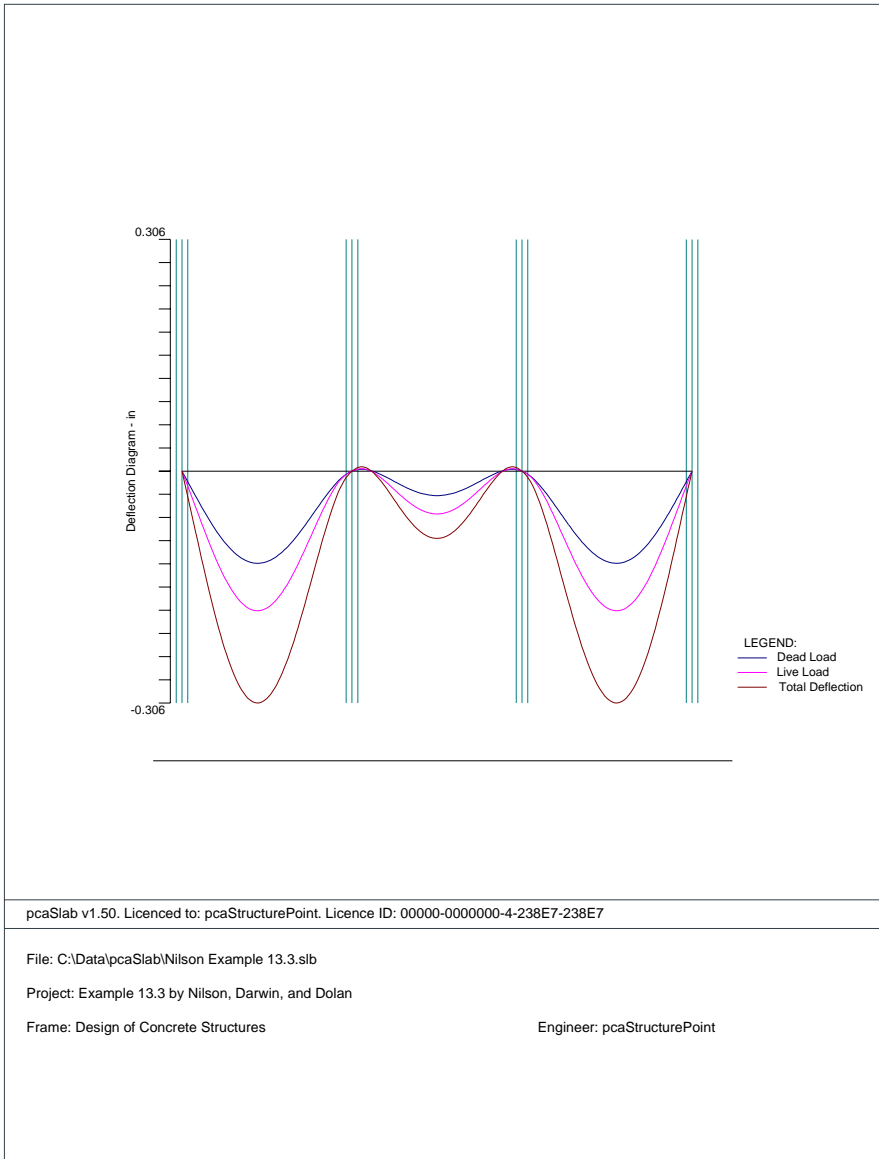

pcaSlab v1.50. Licenced to: pcaStructurePoint. Licence ID: 00000-0000000-4-238E7-238E7

File: C:\Data\pcaSlab\Nilson Example 13.3.slb

Project: Example 13.3 by Nilson, Darwin, and Dolan

Frame: Design of Concrete Structures

Engineer: pcaStructurePoint

Reinforcement

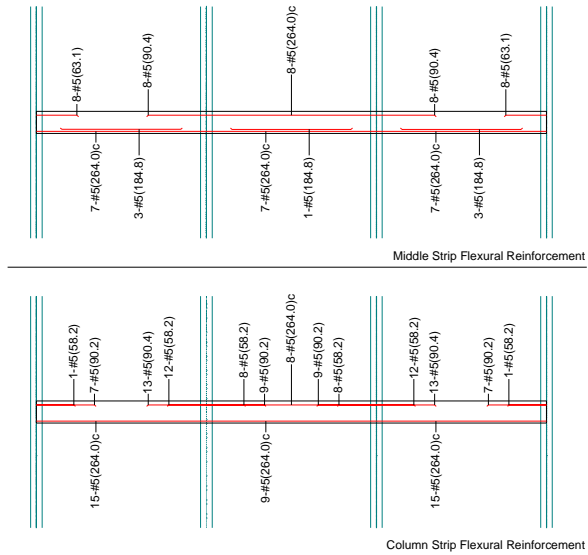

pcaSlab v1.50. Licensed to: pcaStructurePoint. Licence ID: 00000-0000000-4-238E7-238E7

File: C:\Data\pcaSlab\Nilson Example 13.3.slb

Project: Example 13.3 by Nilson, Darwin, and Dolan

Frame: Design of Concrete Structures

Engineer: pcaStructurePoint

Example 5 Two-way slab system

Problem description

Using the Equivalent Frame Method, determine design moments for the slab system in the direction shown, for an intermediate floor. This example refers to Example 20-2 from *PCA Notes on ACI 318-02 Building Code Requirements for Structural Concrete*, Portland Cement Association, 2002.

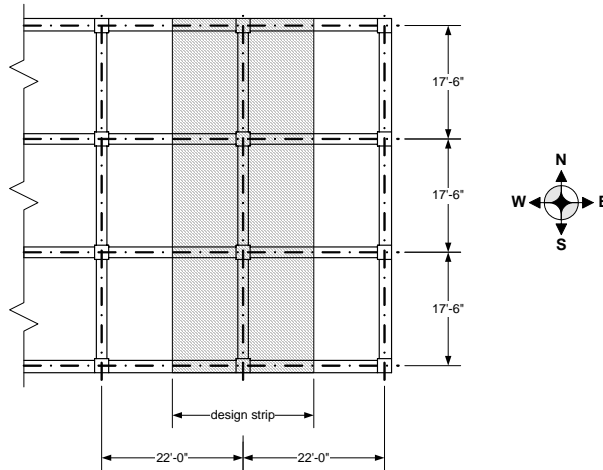

Story height = 12 ft

Edge beam dimensions = 14 × 27 in.

Interior beam dimensions = 14 × 20 in.

Column dimensions = 18 × 18 in.

Service live load = 100 psf

Dead load = self weight

f'_c = 4000 psi (for all members), normal weight concrete

f_y = 60,000 psi

Program Input

1. From the **Input** menu, select **General Information**. A dialog box appears.
 - In the LABELS section, input the names of the project, frame, and engineer.
 - In the FRAME section, input 4 for NO OF SUPPORTS.

- In the FLOOR SYSTEM section, click the radial button next to TWO-WAY.
- Leave all other options in the **General Information** tab to their default settings of ACI 318-02 design code, ASTM A615 reinforcement, and DESIGN run mode option.

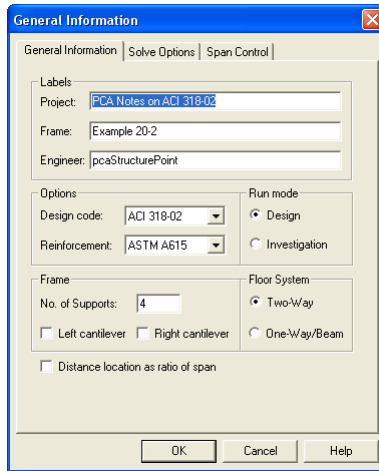

2. Nothing needs to be changed in the **Material Properties** menu.

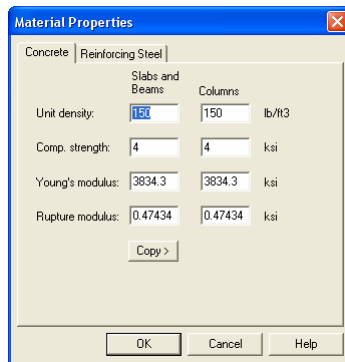

3. From the **Input** menu, select **Spans**. A dialog box appears.
 - Under the **Slabs/Flanges** tab, input 17.5 for LENGTH, 6 for THICKNESS, and 11 for WIDTH LEFT and WIDTH RIGHT. Press MODIFY.
 - Press COPY. Press the CHECK ALL button. Press OK.

- Select the **Longitudinal Beams** tab. Input 14 for WIDTH and 20 for DEPTH. Press MODIFY.
- Press COPY. Press the CHECK ALL button. Press OK.
- Press OK again.

Span Data

Slabs/Flanges | Longitudinal Beams | Ribs

Span: 1 Length: 17.5 ft Width Left: 11 ft
 Location: Interior Thickness: 6 in Width Right: 11 ft

Modify Copy...

Span No.	Location	Length	Thickness	Width-L	Width-R
1	Interior	17.5	6	11	11
2	Interior	17.5	6	11	11
3	Interior	17.5	6	11	11

OK Cancel Help

Span Data

Slabs/Flanges | Longitudinal Beams | Ribs

Span: 1 Width: 14 in
 Depth: 20 in

Modify Copy...

Span No.	Width	Depth
1	14	20
2	14	20
3	14	20

OK Cancel Help

4. From the **Input** menu, select **Supports**. A dialog box appears.
 - Under the **Columns** tab, input 12 for the HEIGHT in both the ABOVE and BELOW rows.

- Input 18 for both the c1 and c2 values in both the ABOVE and BELOW rows. Press MODIFY.
- Press COPY. Press the CHECK ALL button. Press OK.
- Under the **Transverse Beams** tab, input 14 for WIDTH and 27 for DEPTH. Press MODIFY.
- Press COPY. Click the check box next to SUPPORT 4. Press OK.
- Use the drop down arrow next to SUPPORT to select SUPPORT 2.
- Input 14 for WIDTH and 20 for DEPTH. Press MODIFY.
- Press COPY. Click the check box next to SUPPORT 3 and unclick the check box next to SUPPORT 1. Press OK.
- Press OK again.

Support Data

Columns | Drop Panels | Column Capitals | **Transverse Beams** | Boundary Conditions

Support: 1

Stiffness share %: 100

Check punching shear around column

Modify Copy...

Sup. No	Stiff%	HtA	c1A	c2A	HtB	c1B	c2B	Shear
1	100	12	18	18	12	18	18	Yes
2	100	12	18	18	12	18	18	Yes
3	100	12	18	18	12	18	18	Yes
4	100	12	18	18	12	18	18	Yes

OK Cancel Help

Support Data

Columns | Drop Panels | Column Capitals | Transverse Beams | Boundary Conditions

Support: 1 Width (in) 14 Offset (in) 0
 Depth (in) 27

Modify Copy...

Sup. No	Width	Depth	Offset
1	14	27	0
2	14	20	0
3	14	20	0
4	14	27	0

OK Cancel Help

5. Nothing needs to be changed in the **Reinforcement** menu.

Reinforcement Criteria

Slabs and Ribs | Beams

Top bars Bottom bars

Cover (in)
 Clear: 1.5 1.5

Bar size
 Min: #5 #5
 Max: #8 #8

Spacing (in)
 Min: 1 1
 Max: 18 18

Reinf. ratio (%)
 Min: 0.14 0.14
 Max: 5 5

Top bars have more than 12 in of concrete below them.

OK Cancel Help

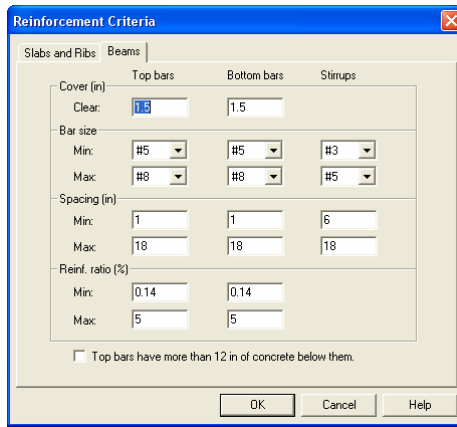

6. From the **Input** menu, select **Load Cases**. A dialog box appears.
 - Since we are not considering lateral forces, click on WIND in the LABEL column on the list in the bottom half of the LOAD CASES dialog box and press the DELETE button.
 - Click on EQ in the LABEL column and press the DELETE button. Press OK.

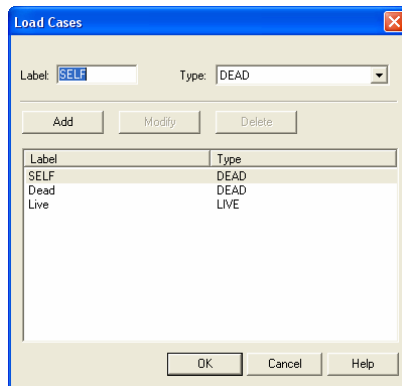

7. From the **Input** menu, select **Load Combinations**. A dialog box appears.
 - Delete all the load combinations by clicking anywhere on the list in the bottom half of the LOAD COMBINATIONS dialog box and pressing the DELETE button. Repeat this procedure until all the load combinations are gone.

- Input 1.2 in the SELF field, 1.2 in the DEAD field, and 1.6 in the LIVE field. Press ADD.
- Press OK.

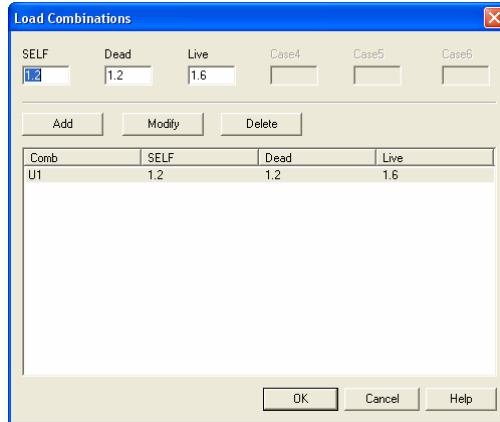

- From the **Input** menu, select **Span Loads**. A dialog box appears.
 - In the top left corner of the SPAN LOADS dialog box, there is a section called CURRENT CASE. Click on LIVE.
 - Input 100 for MAGNITUDE. Press ADD.
 - Press COPY. Press the CHECK ALL button. Press OK.
 - Press OK again.

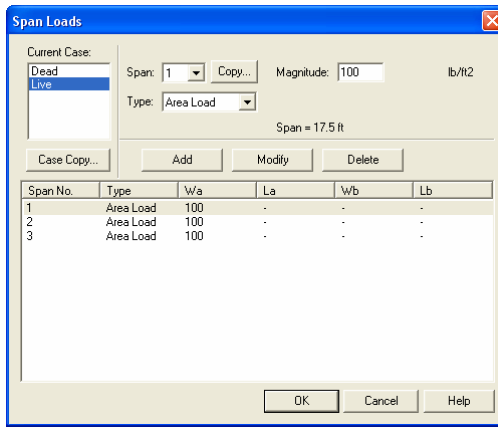

9. From the **Solve** menu, select **Execute**. Press **CLOSE**.
10. From the **Solve** menu, select **Results Report**.
 - Use the scroll bars to scroll through the results file.
 - Use the **ARROW** keys or the mouse wheel to browse through different parts of the results quickly. Press the **CLOSE** button to close the **RESULTS REPORT** dialog box and return to **pcaBeam**.
11. To view diagrams, select **Loads**, **Internal Forces**, **Moment Capacity**, **Shear Capacity**, **Deflection**, or **Reinforcement** from the **View** menu. Right click in any of these diagrams to get new copy, printing, or display options.
12. You may print the results file by selecting **Print Results** from the **File** menu. To print any of the diagrams you selected to view, use the **Print Preview** command found by right clicking in the diagram's window. After viewing the results, you may decide to investigate the input beams under the same loads but with a modified reinforcement configuration.
13. From the **Input** menu, select **General Information**. In the **General Information** dialog box change the **RUN MODE** option to **INVESTIGATION**. Do not change any of the other options. Press **OK**
14. From the **Input** menu, select the different commands under **Reinforcement Criteria** and **Reinforcing Bars** to modify the reinforcement configuration computed by the program.
15. Repeat steps 10 and subsequent to perform the investigation and view the results.

Text Output (abbreviated)

```

oooooooo  oooooo  ooooo
ooooooooo  ooooooooo  ooooooooo
oo  oo  oo  oo  oo  oo
oo  oo  oo  oo  oo  oo
ooooooooo  oo  oooooo  ooooo
ooooooooo  oo  oo  oooooo  ooooo
oo  oo  oo  oo  oo  oo
oo  oooooooooo  oo  oo
oo  oooooo  oo  oo

```

```

ooooo  o  o
ooooooooo  oo  ooooo  oo
oo  oo  oo  o  oo  oo
oooo  oo  o  oo  oo
ooooooooo  oo  oooooo  oooooo
oooo  oo  oo  oo  oo  oo
oo  oo  oo  oo  oo  oo
ooooooooo  oo  o  oo  oo  oo  oo
ooooo  ooo  ooooo  o  ooooo

```

```

=====
                        pcaSlab v1.50 (TM)
A Computer Program Analysis, Design, and Investigation of
Reinforced Concrete Slab and Continuous Beam Systems
=====
Copyright © 2000-2005, Portland Cement Association
All rights reserved

```

Licensee stated above acknowledges that Portland Cement Association (PCA) is not and cannot be responsible for either the accuracy or adequacy of the material supplied as input for processing by the pcaSlab computer program. Furthermore, PCA neither makes any warranty expressed nor implied with respect to the correctness of the output prepared by the pcaSlab program. Although PCA has endeavored to produce pcaSlab error free the program is not and cannot be certified infallible. The final and only responsibility for analysis, design and engineering documents is the licensees. Accordingly, PCA disclaims all responsibility in contract, negligence or other tort for any analysis, design or engineering documents prepared in connection with the use of the pcaSlab program.

```

=====
[1] INPUT ECHO
=====

```

General Information:

```

=====
File name: C:\Data\pcaBeam\PCA Notes on ACI 318-02 Example 20-2.slb
Project: PCA Notes on ACI 318-02
Frame: Example 20-2
Code: ACI 318-02 Mode: Design
Number of supports = 4
Floor System: Two-Way
Engineer: pcaStructurePoint
Reinforcement Database: ASTM A615

Live load pattern ratio = 75%
Minimum free edge for punching shear = 10 times slab thickness
Deflections are based on cracked section properties.
In negative moment regions, Igr and Mcr DO NOT include flange/slab contribution (if available)
Compression reinforcement calculations NOT selected.

```

Material Properties:

```

=====
Slabs|Beams      Columns
-----|-----

```

```

wc = 150 150 lb/ft3
f'c = 4 4 ksi
Ec = 3834.25 3834.25 ksi
fr = 0.474342 0.474342 ksi

fy = 60 ksi, Bars are not epoxy-coated
fyv = 60 ksi
Es = 29000 ksi

```

Reinforcement Database:

```

=====
Units: Db (in), Ab (in^2), Wb (lb/ft)

```

Size	Db	Ab	Wb	Size	Db	Ab	Wb
#3	0.38	0.11	0.38	#4	0.50	0.20	0.67
#5	0.63	0.31	1.04	#6	0.75	0.44	1.50
#7	0.88	0.60	2.04	#8	1.00	0.79	2.67
#9	1.13	1.00	3.40	#10	1.27	1.27	4.30
#11	1.41	1.56	5.31	#14	1.69	2.25	7.65
#18	2.26	4.00	13.60				

Span Data:

```

=====
Slabs: Ll, wL, wR (ft); t, Hmin (in)

```

Span Loc	Ll	t	wL	wR	Hmin
1 Int	17.500	6.00	11.000	11.000	4.44
2 Int	17.500	6.00	11.000	11.000	4.44
3 Int	17.500	6.00	11.000	11.000	4.44

Ribs and Longitudinal Beams: b, h, Sp (in)

Span	Ribs			Beams	
	b	h	Sp	b	h
1	0.00	0.00	0.00	14.00	20.00
2	0.00	0.00	0.00	14.00	20.00
3	0.00	0.00	0.00	14.00	20.00

Support Data:

```

=====
Columns: cla, c2a, clb, c2b (in); Ha, Hb (ft)

```

Supp	cla	c2a	clb	c2b	Ha	clb	c2b	Hb	Red%
1	18.00	18.00	12.000	12.000	18.00	18.00	12.000	12.000	100
2	18.00	18.00	12.000	12.000	18.00	18.00	12.000	12.000	100
3	18.00	18.00	12.000	12.000	18.00	18.00	12.000	12.000	100
4	18.00	18.00	12.000	12.000	18.00	18.00	12.000	12.000	100

Transverse Beams: b, h, Ecc (in)

Supp	b	h	Ecc
1	14.00	27.00	0.00
2	14.00	20.00	0.00
3	14.00	20.00	0.00
4	14.00	27.00	0.00

Boundary Conditions: Kz (kip/in); Kry (kip-in/rad)

Supp	Spring Kz	Spring Kry	Far End A	Far End B
1	0	0	Fixed	Fixed
2	0	0	Fixed	Fixed
3	0	0	Fixed	Fixed
4	0	0	Fixed	Fixed

Load Data:

```

=====
Load Cases and Combinations:
Case SELF Dead Live

```

Type DEAD DEAD LIVE
 U1 1.200 1.200 1.600

Span Loads:

Span Case Wa

Area Loads - Wa (lb/ft2):

1 Live 100
 2 Live 100
 3 Live 100

Support Loads - Fz (kip), My (k-ft):

Supp Case	Fz	My
1 SELF	0	0
2 SELF	0	0
3 SELF	0	0
4 SELF	0	0
1 Dead	0	0
2 Dead	0	0
3 Dead	0	0
4 Dead	0	0
1 Live	0	0
2 Live	0	0
3 Live	0	0
4 Live	0	0

Support Displacements - Dz (in), Ry (rad):

Supp Case	Dz	Ry
1 SELF	0	0
2 SELF	0	0
3 SELF	0	0
4 SELF	0	0
1 Dead	0	0
2 Dead	0	0
3 Dead	0	0
4 Dead	0	0
1 Live	0	0
2 Live	0	0
3 Live	0	0
4 Live	0	0

Reinforcement Criteria:

```

=====
                Top bars      Bottom bars      Stirrups
                Min      Max      Min      Max      Min      Max
                -----
Slabs and Ribs:
  Bar Size      #5      #8      #5      #8
  Bar spacing   1.00   18.00   1.00   18.00 in
  Reinf ratio   0.14   5.00   0.14   5.00 %
  Cover         1.50
Beams:
  Bar Size      #5      #8      #5      #8      #3      #5
  Bar spacing   1.00   18.00   1.00   18.00   6.00   18.00 in
  Reinf ratio   0.14   5.00   0.14   5.00 %
  Cover         1.50
  
```

[2] DESIGN RESULTS

Top Reinforcement:

Units: Width (ft), Mmax (k-ft), Xmax (ft), As (in^2), Sp (in)

Span Strip	Zone	Width	Mmax	Xmax	AsMin	AsMax	SpReq	AsReq	Bars
------------	------	-------	------	------	-------	-------	-------	-------	------

1	Column	Left	7.58	5.48	0.750	0.983	6.883	11.375	0.293	8-#5	*5
		Middle	7.58	0.00	8.750	0.000	6.883	0.000	0.000	---	
		Right	7.58	14.51	16.750	0.983	6.883	11.375	0.784	8-#5	*5
Middle	Left	13.25	17.06	0.750	1.717	12.026	11.357	0.917	14-#5	*5	
	Middle	13.25	0.00	8.750	0.000	12.026	0.000	0.000	---		
	Right	13.25	47.02	16.750	1.717	12.026	11.357	2.584	14-#5	*5	
Beam	Left	1.17	31.07	0.750	0.512	4.599	9.972	0.385	2-#5		
	Middle	1.17	0.00	8.750	0.000	4.599	0.000	0.000	---		
	Right	1.17	82.21	16.750	0.849	4.599	3.324	1.042	4-#5		
2	Column	Left	7.58	13.03	0.750	0.983	6.883	11.375	0.703	8-#5	*5
		Middle	7.58	0.28	6.350	0.983	6.883	11.375	0.015	8-#5	*5
		Right	7.58	13.03	16.750	0.983	6.883	11.375	0.703	8-#5	*5
Middle	Left	13.25	42.23	0.750	1.717	12.026	11.357	2.312	14-#5	*5	
	Middle	13.25	0.91	6.350	1.717	12.026	11.357	0.049	14-#5	*5	
	Right	13.25	42.23	16.750	1.717	12.026	11.357	2.312	14-#5	*5	
Beam	Left	1.17	73.83	0.750	0.849	4.599	3.324	0.932	4-#5		
	Middle	1.17	1.60	6.350	0.356	4.599	9.972	0.020	2-#5		
	Right	1.17	73.83	16.750	0.849	4.599	3.324	0.932	4-#5		
3	Column	Left	7.58	14.51	0.750	0.983	6.883	11.375	0.784	8-#5	*5
		Middle	7.58	0.00	8.750	0.000	6.883	0.000	0.000	---	
		Right	7.58	5.41	16.750	0.983	6.883	11.375	0.289	8-#5	*5
Middle	Left	13.25	47.02	0.750	1.717	12.026	11.357	2.584	14-#5	*5	
	Middle	13.25	0.00	8.750	0.000	12.026	0.000	0.000	---		
	Right	13.25	17.54	16.750	1.717	12.026	11.357	0.942	14-#5	*5	
Beam	Left	1.17	82.21	0.750	0.849	4.599	3.324	1.042	4-#5		
	Middle	1.17	0.00	8.750	0.000	4.599	0.000	0.000	---		
	Right	1.17	30.66	16.750	0.505	4.599	9.972	0.380	2-#5		

NOTES:

*5 - Number of bars governed by maximum allowable spacing.

Top Bar Details:

=====

Units: Length (ft)

Span Strip	Bars	Left		Continuous		Right				
		Length	Bars	Length	Length	Bars	Length	Bars	Length	
1 Column	4-#5	6.03	4-#5	3.95	---	4-#5	6.75	4-#5	3.95	
Middle	14-#5	4.27	---	---	---	14-#5	6.75	---	---	
Beam	2-#5	4.02	---	---	---	3-#5	7.27	1-#5	2.56	
2 Column	---	---	---	---	8-#5	17.50	---	---	---	
Middle	---	---	---	---	14-#5	17.50	---	---	---	
Beam	1-#5	3.25	1-#5	2.27	2-#5	17.50	1-#5	3.25	1-#5	2.27
3 Column	4-#5	6.75	4-#5	3.95	---	4-#5	6.03	4-#5	3.95	
Middle	14-#5	6.75	---	---	---	14-#5	4.27	---	---	
Beam	3-#5	7.27	1-#5	2.56	---	2-#5	4.02	---	---	

Bottom Reinforcement:

=====

Units: Width (ft), Mmax (k-ft), Xmax (ft), As (in²), Sp (in)

Span Strip	Width	Mmax	Xmax	AsMin	AsMax	SpReq	AsReq	Bars
1 Column	7.58	8.87	7.750	0.983	6.883	11.375	0.476	8-#5 *5
Middle	13.25	28.76	7.750	1.717	12.026	11.357	1.559	14-#5 *5
Beam	1.17	50.29	7.750	0.835	4.599	4.986	0.628	3-#5
2 Column	7.58	6.45	8.750	0.983	6.883	11.375	0.345	8-#5 *5
Middle	13.25	20.90	8.750	1.717	12.026	11.357	1.126	14-#5 *5
Beam	1.17	36.54	8.750	0.603	4.599	9.972	0.454	2-#5
3 Column	7.58	8.87	9.750	0.983	6.883	11.375	0.476	8-#5 *5
Middle	13.25	28.76	9.750	1.717	12.026	11.357	1.559	14-#5 *5

Beam 1.17 50.29 9.750 0.835 4.599 4.986 0.628 3-#5
 NOTES:
 *5 - Number of bars governed by maximum allowable spacing.

Bottom Bar Details:

=====

Units: Start (ft), Length (ft)

Span Strip	Long Bars			Short Bars		
	Bars	Start	Length	Bars	Start	Length
1 Column	8-#5	0.00	17.50	---		
	Middle	7-#5	0.00	17.50	7-#5	2.63 12.25
	Beam	3-#5	0.00	17.50	---	
2 Column	8-#5	0.00	17.50	---		
	Middle	7-#5	0.00	17.50	7-#5	2.63 12.25
	Beam	2-#5	0.00	17.50	---	
3 Column	8-#5	0.00	17.50	---		
	Middle	7-#5	0.00	17.50	7-#5	2.63 12.25
	Beam	3-#5	0.00	17.50	---	

Flexural Capacity:

=====

Units: From, To (ft), As (in²), PhiMn (k-ft)

Span Strip	From	To	As (in ²)		PhiMn-	PhiMn+	
			AsTop	AsBot			
1 Column	0.000	0.750	2.48	2.48	-44.05	44.05	
	0.750	2.951	2.48	2.48	-44.05	44.05	
	2.951	3.951	1.24	2.48	-22.70	44.05	
	3.951	5.030	1.24	2.48	-22.70	44.05	
	5.030	6.030	0.00	2.48	0.00	44.05	
	6.030	6.350	0.00	2.48	0.00	44.05	
	6.350	8.750	0.00	2.48	0.00	44.05	
	8.750	10.750	0.00	2.48	0.00	44.05	
	10.750	11.150	0.00	2.48	0.00	44.05	
	11.150	11.750	0.00	2.48	0.00	44.05	
	11.750	13.549	1.24	2.48	-22.70	44.05	
	13.549	14.549	1.24	2.48	-22.70	44.05	
	14.549	16.750	2.48	2.48	-44.05	44.05	
	16.750	17.500	2.48	2.48	-44.05	44.05	
	Middle	0.000	0.750	4.34	2.17	-77.08	39.72
		0.750	2.625	4.34	2.17	-77.08	39.72
2.625		3.271	4.34	2.17	-77.08	39.72	
3.271		3.625	0.00	2.17	0.00	39.72	
3.625		4.271	0.00	4.34	0.00	77.08	
4.271		6.350	0.00	4.34	0.00	77.08	
6.350		8.750	0.00	4.34	0.00	77.08	
8.750		10.750	0.00	4.34	0.00	77.08	
10.750		11.150	0.00	4.34	0.00	77.08	
11.150		11.750	0.00	4.34	0.00	77.08	
11.750		13.875	4.34	4.34	-77.08	77.08	
13.875		14.875	4.34	2.17	-77.08	39.72	
14.875		16.750	4.34	2.17	-77.08	39.72	
16.750		17.500	4.34	2.17	-77.08	39.72	
Beam		0.000	0.750	0.62	0.93	-49.65	73.66
		0.750	3.016	0.62	0.93	-49.65	73.66
	3.016	4.016	0.00	0.93	0.00	73.66	
	4.016	6.350	0.00	0.93	0.00	73.66	
	6.350	8.750	0.00	0.93	0.00	73.66	
	8.750	10.234	0.00	0.93	0.00	73.66	
	10.234	11.150	0.00	0.93	0.00	73.66	
	11.150	11.234	0.00	0.93	0.00	73.66	
	11.234	14.939	0.93	0.93	-73.66	73.66	
	14.939	15.939	0.93	0.93	-73.66	73.66	
	15.939	16.750	1.24	0.93	-97.13	73.66	
16.750	17.500	1.24	0.93	-97.13	73.66		

2 Column	0.000	0.750	2.48	2.48	-44.05	44.05	
	0.750	6.350	2.48	2.48	-44.05	44.05	
	6.350	8.750	2.48	2.48	-44.05	44.05	
	8.750	11.150	2.48	2.48	-44.05	44.05	
	11.150	16.750	2.48	2.48	-44.05	44.05	
	16.750	17.500	2.48	2.48	-44.05	44.05	
	Middle	0.000	0.750	4.34	2.17	-77.08	39.72
		0.750	2.625	4.34	2.17	-77.08	39.72
		2.625	3.625	4.34	2.17	-77.08	39.72
		3.625	6.350	4.34	4.34	-77.08	77.08
		6.350	8.750	4.34	4.34	-77.08	77.08
		8.750	11.150	4.34	4.34	-77.08	77.08
		11.150	13.875	4.34	4.34	-77.08	77.08
		13.875	14.875	4.34	2.17	-77.08	39.72
		14.875	16.750	4.34	2.17	-77.08	39.72
		16.750	17.500	4.34	2.17	-77.08	39.72
Beam		0.000	0.750	1.24	0.62	-97.13	49.65
		0.750	1.272	1.24	0.62	-97.13	49.65
		1.272	2.246	0.93	0.62	-73.66	49.65
		2.246	2.272	0.62	0.62	-49.65	49.65
		2.272	3.246	0.62	0.62	-49.65	49.65
		3.246	6.350	0.62	0.62	-49.65	49.65
	6.350	8.750	0.62	0.62	-49.65	49.65	
	8.750	11.150	0.62	0.62	-49.65	49.65	
	11.150	14.254	0.62	0.62	-49.65	49.65	
	14.254	15.228	0.62	0.62	-49.65	49.65	
	15.228	15.254	0.62	0.62	-49.65	49.65	
	15.254	16.228	0.93	0.62	-73.66	49.65	
	16.228	16.750	1.24	0.62	-97.13	49.65	
	16.750	17.500	1.24	0.62	-97.13	49.65	
	3 Column	0.000	0.750	2.48	2.48	-44.05	44.05
		0.750	2.951	2.48	2.48	-44.05	44.05
2.951		3.951	1.24	2.48	-22.70	44.05	
3.951		5.750	1.24	2.48	-22.70	44.05	
5.750		6.350	0.00	2.48	0.00	44.05	
6.350		6.750	0.00	2.48	0.00	44.05	
6.750		8.750	0.00	2.48	0.00	44.05	
8.750		11.150	0.00	2.48	0.00	44.05	
11.150		11.470	0.00	2.48	0.00	44.05	
11.470		12.470	0.00	2.48	0.00	44.05	
12.470		13.549	1.24	2.48	-22.70	44.05	
13.549		14.549	1.24	2.48	-22.70	44.05	
14.549		16.750	2.48	2.48	-44.05	44.05	
16.750		17.500	2.48	2.48	-44.05	44.05	
Middle		0.000	0.750	4.34	2.17	-77.08	39.72
		0.750	2.625	4.34	2.17	-77.08	39.72
	2.625	3.625	4.34	2.17	-77.08	39.72	
	3.625	5.750	4.34	4.34	-77.08	77.08	
	5.750	6.350	0.00	4.34	0.00	77.08	
	6.350	6.750	0.00	4.34	0.00	77.08	
	6.750	8.750	0.00	4.34	0.00	77.08	
	8.750	11.150	0.00	4.34	0.00	77.08	
	11.150	13.229	0.00	4.34	0.00	77.08	
	13.229	13.875	0.00	4.34	0.00	77.08	
	13.875	14.229	0.00	2.17	0.00	39.72	
	14.229	14.875	4.34	2.17	-77.08	39.72	
	14.875	16.750	4.34	2.17	-77.08	39.72	
	16.750	17.500	4.34	2.17	-77.08	39.72	
	Beam	0.000	0.750	1.24	0.93	-97.13	73.66
		0.750	1.561	1.24	0.93	-97.13	73.66
1.561		2.561	0.93	0.93	-73.66	73.66	
2.561		6.266	0.93	0.93	-73.66	73.66	
6.266		6.350	0.00	0.93	0.00	73.66	
6.350		7.266	0.00	0.93	0.00	73.66	
7.266		8.750	0.00	0.93	0.00	73.66	
8.750		11.150	0.00	0.93	0.00	73.66	
11.150		13.484	0.00	0.93	0.00	73.66	

13.484	14.484	0.00	0.93	0.00	73.66
14.484	16.750	0.62	0.93	-49.65	73.66
16.750	17.500	0.62	0.93	-49.65	73.66

Longitudinal Beam Shear Reinforcement Required:

```

=====
Units: d (in), Start, End, Xu (ft), PhiVc, Vu (kip), Av/s (in^2/in)
Span      d      PhiVc    Start    End      Vu      Xu      Av/s
-----
1  18.19  24.16  2.266  4.118  31.62  2.266  0.0117
      4.118  5.971  20.98  4.118  0.0117
      5.971  7.824  10.76  5.971  0.0000
      7.824  9.676  10.95  9.676  0.0000
      9.676  11.529 21.60  11.529 0.0117
      11.529 13.382 32.24  13.382 0.0117
      13.382 15.234 42.89  15.234 0.0229

2  18.19  24.16  2.266  4.118  37.25  2.266  0.0160
      4.118  5.971  26.61  4.118  0.0117
      5.971  7.824  15.97  5.971  0.0117
      7.824  9.676  6.88   7.824  0.0000
      9.676  11.529 15.97  11.529 0.0117
      11.529 13.382 26.61  13.382 0.0117
      13.382 15.234 37.25  15.234 0.0160

3  18.19  24.16  2.266  4.118  42.89  2.266  0.0229
      4.118  5.971  32.24  4.118  0.0117
      5.971  7.824  21.60  5.971  0.0117
      7.824  9.676  10.95  7.824  0.0000
      9.676  11.529 10.76  11.529 0.0000
      11.529 13.382 20.98  13.382 0.0117
      13.382 15.234 31.62  15.234 0.0117
    
```

Longitudinal Beam Shear Reinforcement Details:

```

=====
Units: spacing & distance (in).
Span Size Stirrups (2 legs each unless otherwise noted)
-----
1  #3 8 @ 8.5 + <-- 44.5 --> + 5 @ 8.9 + 6 @ 7.5
2  #3 11 @ 8.2 + <-- 22.2 --> + 11 @ 8.2
3  #3 5 @ 7.5 + 6 @ 8.9 + <-- 44.5 --> + 8 @ 8.5
    
```

Beam Shear Capacity:

```

=====
Units: d, Sp (in), Start, End, Xu (ft), PhiVc, PhiVn, Vu (kip), Av/s (in^2/in)
Span      d      PhiVc    Start    End      Av/s    Sp      PhiVn    Vu      Xu
-----
1  18.19  24.16  0.000  1.000  -----  -----  45.29  48.46  0.000
      1.000  5.971  0.0258  8.5   45.29  31.62  2.266
      5.971  9.676  -----  -----  12.08  10.95  9.676
      9.676  13.382 0.0247  8.9   44.40  32.24  13.382
      13.382 16.500 0.0294  7.5   48.21  42.89  15.234
      16.500 17.500  -----  -----  48.21  58.45  17.500

2  18.19  24.16  0.000  1.000  -----  -----  46.15  52.82  0.000
      1.000  7.824  0.0269  8.2   46.15  37.25  2.266
      7.824  9.676  -----  -----  12.08  6.88   7.824
      9.676  16.500 0.0269  8.2   46.15  37.25  15.234
      16.500 17.500  -----  -----  46.15  52.82  17.500

3  18.19  24.16  0.000  1.000  -----  -----  48.21  58.45  0.000
      1.000  4.118  0.0294  7.5   48.21  42.89  2.266
      4.118  7.824  0.0247  8.9   44.40  32.24  4.118
      7.824  11.529 -----  -----  12.08  10.95  7.824
      11.529 16.500 0.0258  8.5   45.29  31.62  15.234
      16.500 17.500  -----  -----  45.29  48.46  17.500
    
```

Slab Shear Capacity:

```

=====
Units: b, d (in), Xu (ft), PhiVc, Vu(kip)
Span      b          d      Vratio      PhiVc          Vu          Xu
-----
1  250.00    4.19    0.000      99.32          0.00       16.40
2  250.00    4.19    0.000      99.32          0.00       1.10
3  250.00    4.19    0.000      99.32          0.00       1.10
  
```

Flexural Transfer of Negative Unbalanced Moment at Supports:

```

=====
Units: Width (in), Munb (k-ft), As (in^2)
Supp      Width      GammaP*Munb  Comb Pat      AsReq      AsProv  Additional Bars
-----
1  36.00          58.85 U1    All    4.113      0.981    11-#5
2  36.00          28.78 U1    Odd    1.696      0.981     3-#5
3  36.00          28.74 U1    Odd    1.693      0.981     3-#5
4  36.00          58.88 U1    All    4.116      0.981    11-#5
  
```

Punching Shear Around Columns:

```

=====
Units: Vu (kip), Munb (k-ft), vu (psi), Phi*vc (psi)
Supp      Vu          vu          Munb Comb Pat      GammaV          vu      Phi*vc
-----
1  47.98      91.0          58.82 U1    All    0.320      139.3      177.4
2  110.33     128.9         -18.90 U1    All    0.400      142.1      181.1
3  110.33     128.9          18.84 U1    All    0.400      142.0      181.1
4  47.98     100.6         -55.95 U1    All    0.320      144.4      181.1
  
```

Maximum Deflections:

```

=====
Units: Dz (in)
Span      Frame          Column Strip          Middle Strip
Dz(DEAD) Dz(LIVE) Dz(TOTAL)  Dz(DEAD) Dz(LIVE) Dz(TOTAL)  Dz(DEAD) Dz(LIVE) Dz(TOTAL)
-----
1  -0.014  -0.017  -0.032  -0.012  -0.015  -0.027  -0.041  -0.050  -0.091
2  -0.007  -0.008  -0.015  -0.006  -0.007  -0.013  -0.020  -0.024  -0.044
3  -0.014  -0.017  -0.032  -0.012  -0.015  -0.027  -0.042  -0.050  -0.092
  
```

Material Takeoff:

```

=====
Reinforcement in the Direction of Analysis
-----
Top Bars:      1011.5 lb <=> 19.27 lb/ft <=> 0.876 lb/ft^2
Bottom Bars:   1235.7 lb <=> 23.54 lb/ft <=> 1.070 lb/ft^2
Stirrups:      315.8 lb <=> 6.02 lb/ft <=> 0.273 lb/ft^2
Total Steel:   2563.1 lb <=> 48.82 lb/ft <=> 2.219 lb/ft^2
Concrete:      798.7 ft^3 <=> 15.21 ft^3/ft <=> 0.691 ft^3/ft^2
  
```

[3] COLUMN AXIAL FORCES AND MOMENTS

```

=====
Units: P (kip), M (k-ft)
Supp Case/Patt      P (axial)      Mb[top]      Ma[bottom]
-----
1 SELF              17.58          -17.11        -11.14
  Dead              0.00           0.00           0.00
  Live/All          17.11          -19.94        -12.99
  Live/Odd          14.09          -18.32        -11.93
  Live/Even         -1.26           3.36           2.19
  Live/S1           13.83          -17.63        -11.48
  Live/S2           12.57          -14.27         -9.29
  Live/S3           -1.00           2.67           1.74
  Live/S4            0.26           -0.69         -0.45
  
```

2	SELF	38.54	3.75	2.44
	Dead	0.00	0.00	0.00
	Live/All	40.64	4.35	2.83
	Live/Odd	14.78	15.35	9.99
	Live/Even	15.70	-12.09	-7.87
	Live/S1	16.52	12.87	8.38
	Live/S2	32.22	0.78	0.51
	Live/S3	13.96	-9.61	-6.26
	Live/S4	-1.74	2.48	1.62
3	SELF	38.54	-3.72	-2.42
	Dead	0.00	0.00	0.00
	Live/All	40.64	-4.35	-2.83
	Live/Odd	14.78	-15.35	-9.99
	Live/Even	15.70	12.09	7.87
	Live/S1	-1.74	-2.48	-1.62
	Live/S2	13.96	9.61	6.26
	Live/S3	32.22	-0.78	-0.51
	Live/S4	16.52	-12.87	-8.38
4	SELF	17.58	17.13	11.16
	Dead	0.00	0.00	0.00
	Live/All	17.11	19.94	12.99
	Live/Odd	14.09	18.32	11.93
	Live/Even	-1.26	-3.36	-2.19
	Live/S1	0.26	0.69	0.45
	Live/S2	-1.00	-2.67	-1.74
	Live/S3	12.57	14.27	9.29
	Live/S4	13.83	17.63	11.48
Sum	SELF	112.23	0.05	0.03
	Dead	0.00	0.00	0.00
	Live/All	115.50	-0.00	-0.00
	Live/Odd	57.75	-0.00	-0.00
	Live/Even	28.87	0.00	0.00
	Live/S1	28.88	-6.55	-4.27
	Live/S2	57.75	-6.55	-4.27
	Live/S3	57.75	6.55	4.27
	Live/S4	28.88	6.55	4.27

=====

[6] SEGMENTAL MOMENT AND SHEAR - ENVELOPES

=====

Span	x (ft)	M- (k-ft)	Comb	M+ (k-ft)	Comb	V- (kip)	Comb	V+ (kip)	Comb
1	0.000	-86.59	U1	0.00	U1	0.00	U1	48.46	U1
	0.250	-74.86	U1	0.00	U1	0.00	U1	45.39	U1
	0.500	-63.89	U1	0.00	U1	0.00	U1	42.31	U1
	0.750	-53.57	U1	0.00	U1	0.00	U1	40.33	U1
	0.750	-53.61	U1	0.00	U1	0.00	U1	40.33	U1
	1.000	-43.80	U1	0.00	U1	0.00	U1	38.89	U1
	1.250	-35.22	U1	0.00	U1	0.00	U1	37.45	U1
	1.500	-26.94	U1	0.00	U1	0.00	U1	36.02	U1
	1.750	-18.96	U1	0.00	U1	0.00	U1	34.58	U1
	2.000	-11.29	U1	2.13	U1	0.00	U1	33.15	U1
	2.250	-3.92	U1	4.76	U1	0.00	U1	31.71	U1
	2.500	0.00	U1	8.16	U1	0.00	U1	30.27	U1
	2.750	0.00	U1	15.55	U1	0.00	U1	28.84	U1
	3.000	0.00	U1	22.58	U1	0.00	U1	27.40	U1
	3.250	0.00	U1	29.25	U1	0.00	U1	25.96	U1
	3.500	0.00	U1	35.57	U1	0.00	U1	24.53	U1
	3.750	0.00	U1	41.52	U1	0.00	U1	23.09	U1
	4.000	0.00	U1	47.11	U1	0.00	U1	21.66	U1
	4.250	0.00	U1	52.35	U1	0.00	U1	20.22	U1
	4.500	0.00	U1	57.22	U1	0.00	U1	18.78	U1

4.750	0.00 U1	61.74 U1	0.00 U1	17.35 U1
5.000	0.00 U1	65.89 U1	0.00 U1	15.91 U1
5.250	0.00 U1	69.69 U1	0.00 U1	14.47 U1
5.500	0.00 U1	73.13 U1	0.00 U1	13.05 U1
5.750	0.00 U1	76.21 U1	0.00 U1	11.83 U1
6.000	0.00 U1	78.93 U1	0.00 U1	10.62 U1
6.250	0.00 U1	81.29 U1	0.00 U1	9.40 U1
6.500	0.00 U1	83.30 U1	0.00 U1	8.19 U1
6.750	0.00 U1	84.94 U1	0.00 U1	6.97 U1
7.000	0.00 U1	86.23 U1	-0.33 U1	5.75 U1
7.250	0.00 U1	87.15 U1	-0.88 U1	4.54 U1
7.500	0.00 U1	87.72 U1	-1.44 U1	3.32 U1
7.750	0.00 U1	87.93 U1	-2.00 U1	2.10 U1
8.000	0.00 U1	87.77 U1	-2.55 U1	0.89 U1
8.250	0.00 U1	87.26 U1	-3.11 U1	0.00 U1
8.500	0.00 U1	86.39 U1	-4.20 U1	0.00 U1
8.750	0.00 U1	85.16 U1	-5.63 U1	0.00 U1
9.000	0.00 U1	83.58 U1	-7.07 U1	0.00 U1
9.250	0.00 U1	81.63 U1	-8.51 U1	0.00 U1
9.500	0.00 U1	79.32 U1	-9.94 U1	0.00 U1
9.750	0.00 U1	76.66 U1	-11.38 U1	0.00 U1
10.000	0.00 U1	73.66 U1	-12.81 U1	0.00 U1
10.250	0.00 U1	71.30 U1	-14.25 U1	0.00 U1
10.500	0.00 U1	68.63 U1	-15.69 U1	0.00 U1
10.750	0.00 U1	65.66 U1	-17.12 U1	0.00 U1
11.000	0.00 U1	62.38 U1	-18.56 U1	0.00 U1
11.250	0.00 U1	58.81 U1	-20.00 U1	0.00 U1
11.500	0.00 U1	54.92 U1	-21.43 U1	0.00 U1
11.750	0.00 U1	50.74 U1	-22.87 U1	0.00 U1
12.000	-1.16 U1	46.25 U1	-24.30 U1	0.00 U1
12.250	-4.09 U1	41.45 U1	-25.74 U1	0.00 U1
12.500	-7.16 U1	36.35 U1	-27.18 U1	0.00 U1
12.750	-10.37 U1	30.95 U1	-28.61 U1	0.00 U1
13.000	-13.72 U1	25.24 U1	-30.05 U1	0.00 U1
13.250	-17.21 U1	19.23 U1	-31.49 U1	0.00 U1
13.500	-20.84 U1	12.92 U1	-32.92 U1	0.00 U1
13.750	-24.61 U1	6.30 U1	-34.36 U1	0.00 U1
14.000	-28.51 U1	0.00 U1	-35.79 U1	0.00 U1
14.250	-32.71 U1	0.00 U1	-37.23 U1	0.00 U1
14.500	-42.20 U1	0.00 U1	-38.67 U1	0.00 U1
14.750	-52.04 U1	0.00 U1	-40.10 U1	0.00 U1
15.000	-62.25 U1	0.00 U1	-41.54 U1	0.00 U1
15.250	-72.81 U1	0.00 U1	-42.98 U1	0.00 U1
15.500	-83.74 U1	0.00 U1	-44.41 U1	0.00 U1
15.750	-95.02 U1	0.00 U1	-45.85 U1	0.00 U1
16.000	-106.66 U1	0.00 U1	-47.28 U1	0.00 U1
16.250	-118.66 U1	0.00 U1	-48.72 U1	0.00 U1
16.500	-131.02 U1	0.00 U1	-50.16 U1	0.00 U1
16.750	-143.74 U1	0.00 U1	-51.59 U1	0.00 U1
16.750	-143.74 U1	0.00 U1	-51.59 U1	0.00 U1
17.000	-156.86 U1	0.00 U1	-53.39 U1	0.00 U1
17.250	-170.53 U1	0.00 U1	-55.92 U1	0.00 U1
17.500	-184.83 U1	0.00 U1	-58.45 U1	0.00 U1

=====

[7] SEGMENTAL DEFLECTIONS

=====

Units: x (ft), Dz (in)				
Span	x	Dz (DEAD)	Dz (LIVE)	Dz (TOTAL)
1	0.000	-0.000	-0.000	-0.000
	0.250	-0.001	-0.001	-0.001
	0.500	-0.001	-0.001	-0.002
	0.750	-0.002	-0.002	-0.003
	0.750	-0.002	-0.002	-0.003
	1.000	-0.002	-0.002	-0.004
	1.250	-0.003	-0.003	-0.006
	1.500	-0.003	-0.004	-0.007

1.750	-0.004	-0.004	-0.008
2.000	-0.004	-0.005	-0.010
2.250	-0.005	-0.006	-0.011
2.500	-0.006	-0.007	-0.012
2.750	-0.006	-0.007	-0.014
3.000	-0.007	-0.008	-0.015
3.250	-0.007	-0.009	-0.016
3.500	-0.008	-0.010	-0.018
3.750	-0.009	-0.010	-0.019
4.000	-0.009	-0.011	-0.020
4.250	-0.010	-0.012	-0.022
4.500	-0.010	-0.012	-0.023
4.750	-0.011	-0.013	-0.024
5.000	-0.011	-0.014	-0.025
5.250	-0.012	-0.014	-0.026
5.500	-0.012	-0.015	-0.027
5.750	-0.013	-0.015	-0.028
6.000	-0.013	-0.016	-0.029
6.250	-0.013	-0.016	-0.029
6.500	-0.014	-0.016	-0.030
6.750	-0.014	-0.017	-0.030
7.000	-0.014	-0.017	-0.031
7.250	-0.014	-0.017	-0.031
7.500	-0.014	-0.017	-0.031
7.750	-0.014	-0.017	-0.032
8.000	-0.014	-0.017	-0.032
8.250	-0.014	-0.017	-0.032
8.500	-0.014	-0.017	-0.031
8.750	-0.014	-0.017	-0.031
9.000	-0.014	-0.017	-0.031
9.250	-0.014	-0.017	-0.030
9.500	-0.014	-0.016	-0.030
9.750	-0.013	-0.016	-0.029
10.000	-0.013	-0.016	-0.029
10.250	-0.013	-0.015	-0.028
10.500	-0.012	-0.015	-0.027
10.750	-0.012	-0.014	-0.026
11.000	-0.011	-0.014	-0.025
11.250	-0.011	-0.013	-0.024
11.500	-0.010	-0.013	-0.023
11.750	-0.010	-0.012	-0.022
12.000	-0.009	-0.011	-0.021
12.250	-0.009	-0.011	-0.020
12.500	-0.008	-0.010	-0.018
12.750	-0.008	-0.009	-0.017
13.000	-0.007	-0.009	-0.016
13.250	-0.007	-0.008	-0.014
13.500	-0.006	-0.007	-0.013
13.750	-0.005	-0.006	-0.012
14.000	-0.005	-0.006	-0.010
14.250	-0.004	-0.005	-0.009
14.500	-0.004	-0.004	-0.008
14.750	-0.003	-0.004	-0.007
15.000	-0.003	-0.003	-0.006
15.250	-0.002	-0.003	-0.005
15.500	-0.002	-0.002	-0.004
15.750	-0.001	-0.002	-0.003
16.000	-0.001	-0.001	-0.002
16.250	-0.001	-0.001	-0.001
16.500	-0.000	-0.001	-0.001
16.750	-0.000	-0.000	-0.001
16.750	-0.000	-0.000	-0.001
17.000	-0.000	-0.000	-0.000
17.250	-0.000	-0.000	-0.000
17.500	-0.000	-0.000	-0.000

Graphical Output

Loads

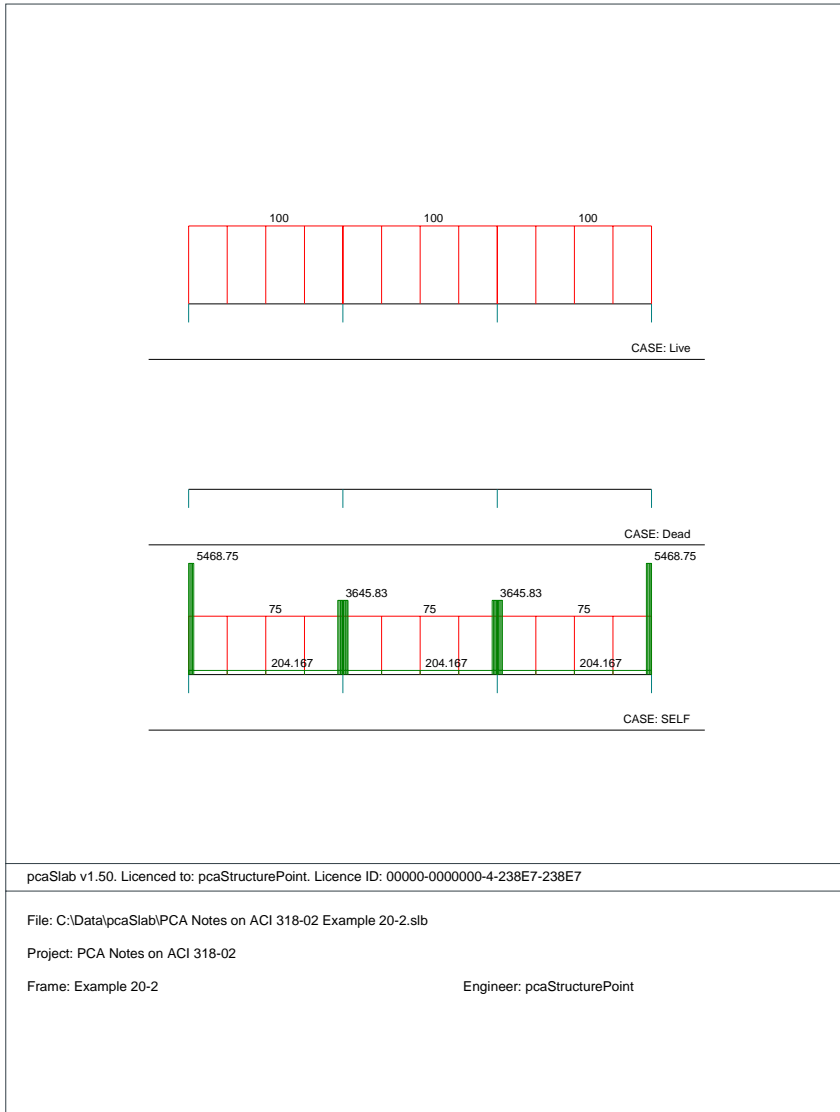

pcaSlab v1.50. Licenced to: pcaStructurePoint. Licence ID: 00000-0000000-4-238E7-238E7

File: C:\Data\pcaSlab\PCA Notes on ACI 318-02 Example 20-2.slb

Project: PCA Notes on ACI 318-02

Frame: Example 20-2

Engineer: pcaStructurePoint

Internal Forces

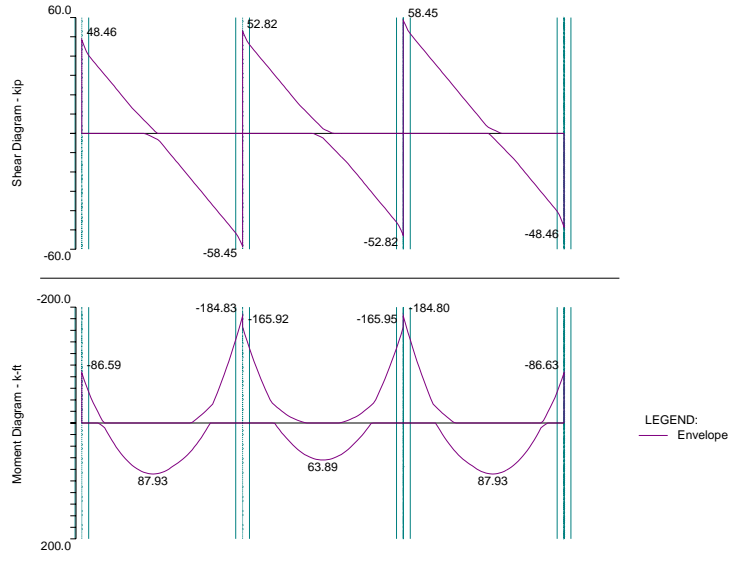

pcaSlab v1.50. Licenced to: pcaStructurePoint. Licence ID: 00000-0000000-4-238E7-238E7

File: C:\Data\pcaSlab\PCA Notes on ACI 318-02 Example 20-2.slb

Project: PCA Notes on ACI 318-02

Frame: Example 20-2

Engineer: pcaStructurePoint

Moment Capacity

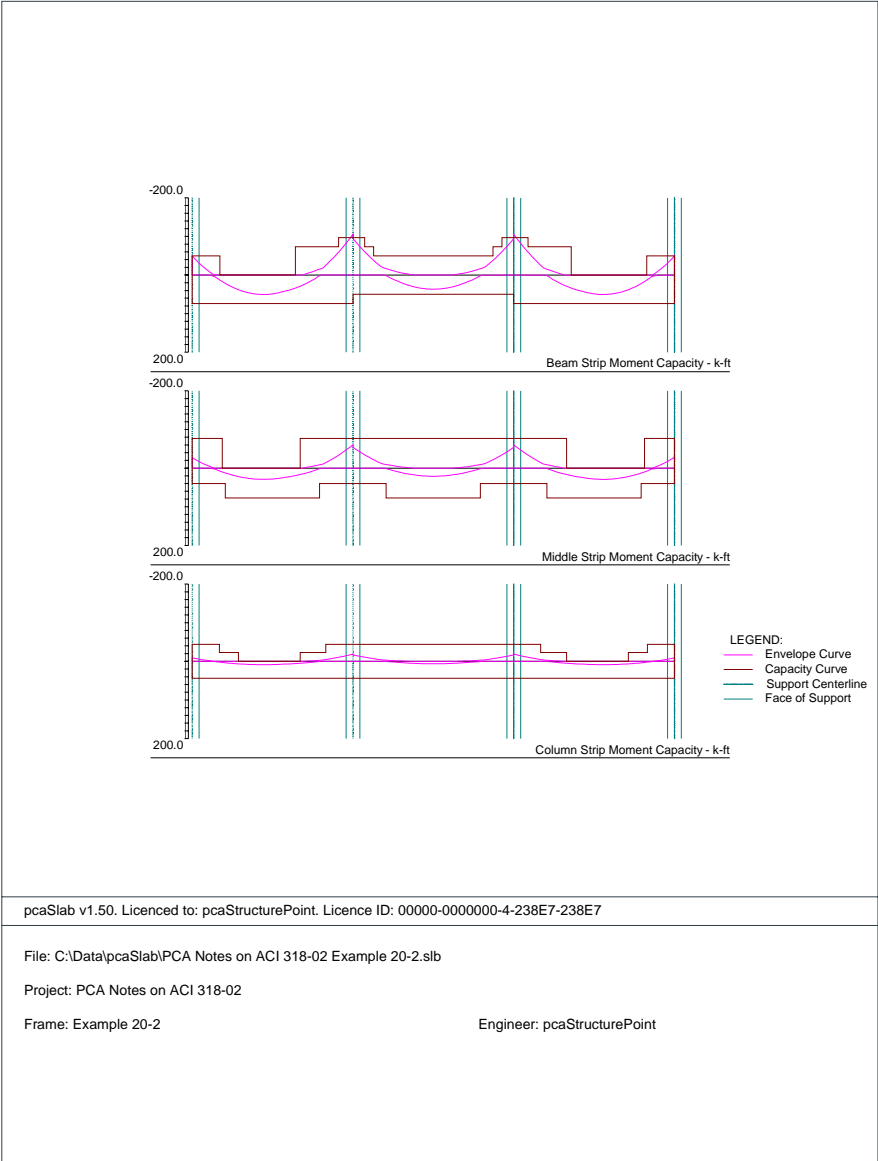

Shear Capacity

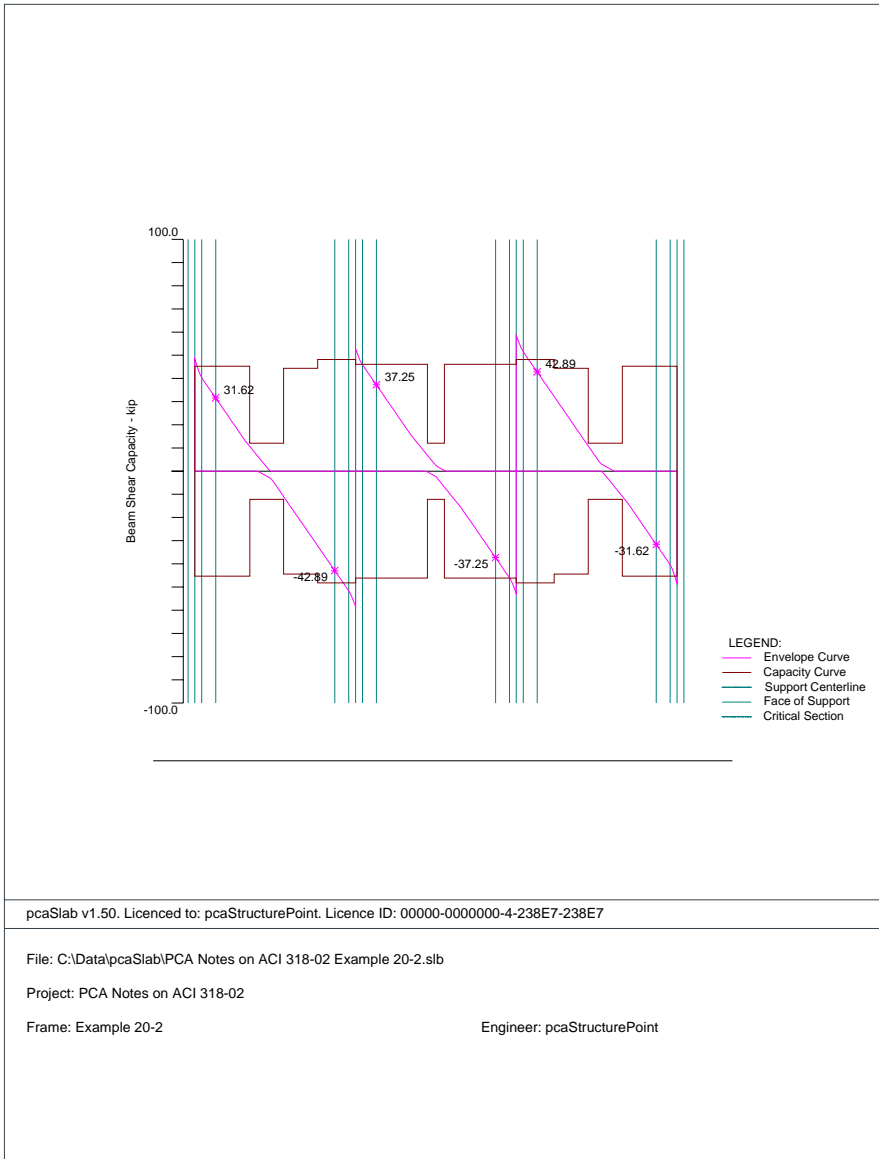

pcaSlab v1.50. Licenced to: pcaStructurePoint. Licence ID: 00000-0000000-4-238E7-238E7

File: C:\Data\pcaSlab\PCA Notes on ACI 318-02 Example 20-2.slb

Project: PCA Notes on ACI 318-02

Frame: Example 20-2

Engineer: pcaStructurePoint

Deflection

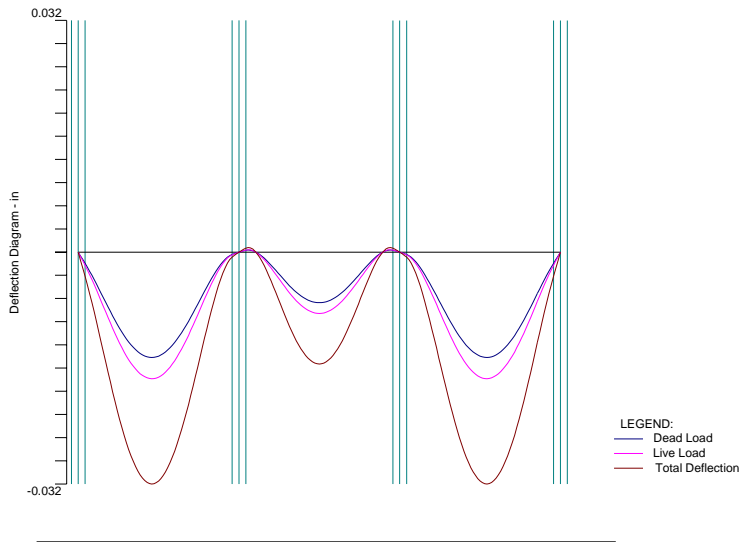

pcaSlab v1.50. Licenced to: pcaStructurePoint. Licence ID: 00000-0000000-4-238E7-238E7

File: C:\Data\pcaSlab\PCA Notes on ACI 318-02 Example 20-2.sib

Project: PCA Notes on ACI 318-02

Frame: Example 20-2

Engineer: pcaStructurePoint

Beam Strip Flexural and Transverse Reinforcement

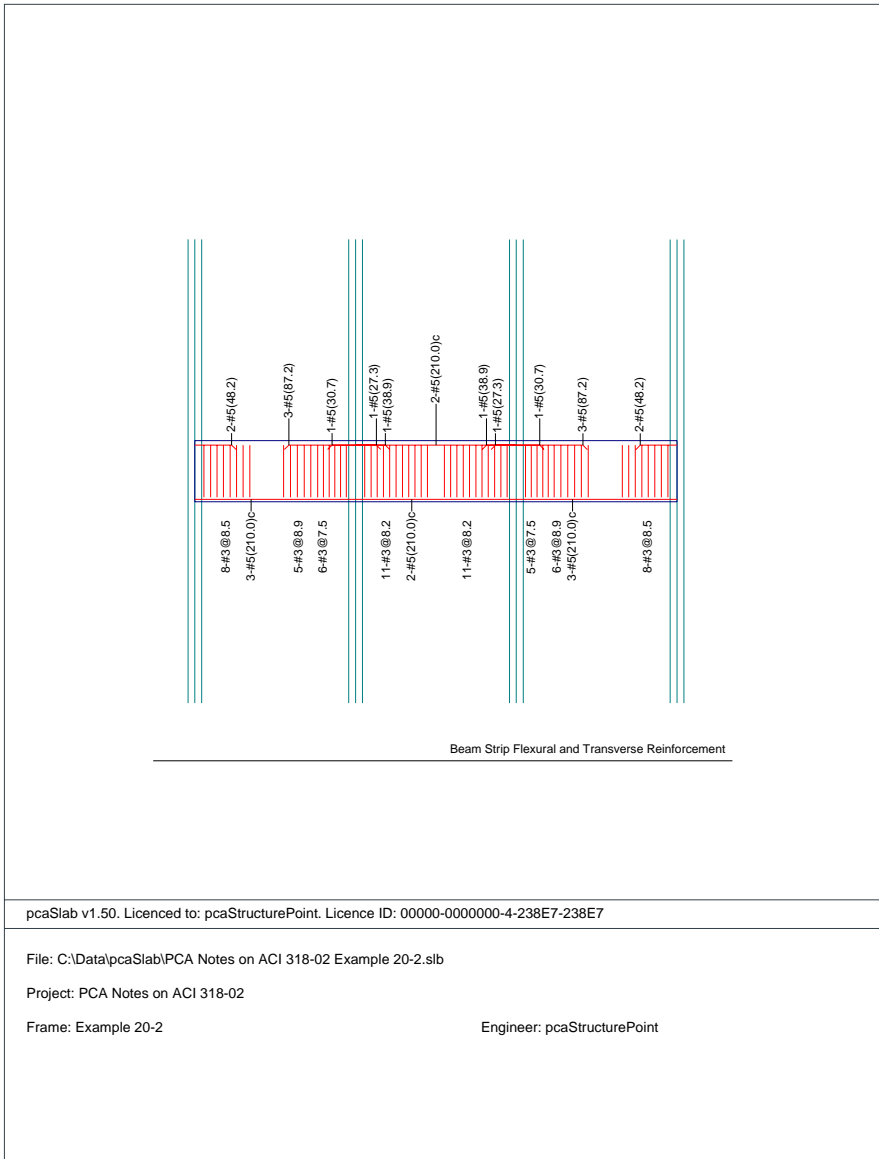

pcaSlab v1.50. Licenced to: pcaStructurePoint. Licence ID: 00000-0000000-4-238E7-238E7

File: C:\Data\pcaSlab\PCA Notes on ACI 318-02 Example 20-2.slb

Project: PCA Notes on ACI 318-02

Frame: Example 20-2

Engineer: pcaStructurePoint

Middle Strip Flexural Reinforcement

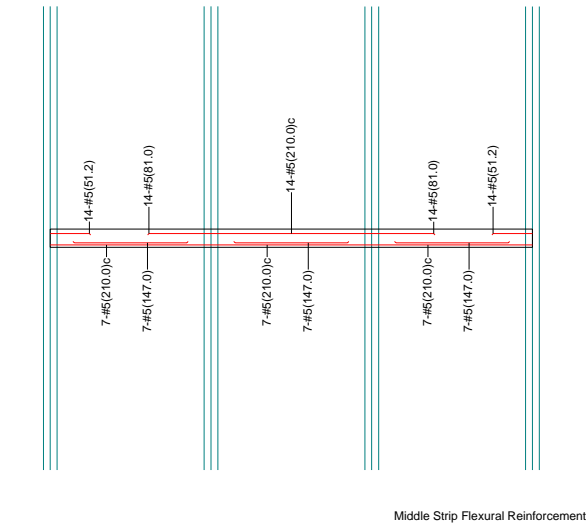

pcaSlab v1.50. Licenced to: pcaStructurePoint. Licence ID: 00000-0000000-4-238E7-238E7

File: C:\Data\pcaSlab\PCA Notes on ACI 318-02 Example 20-2.sib

Project: PCA Notes on ACI 318-02

Frame: Example 20-2

Engineer: pcaStructurePoint

Column Strip Flexural Reinforcement

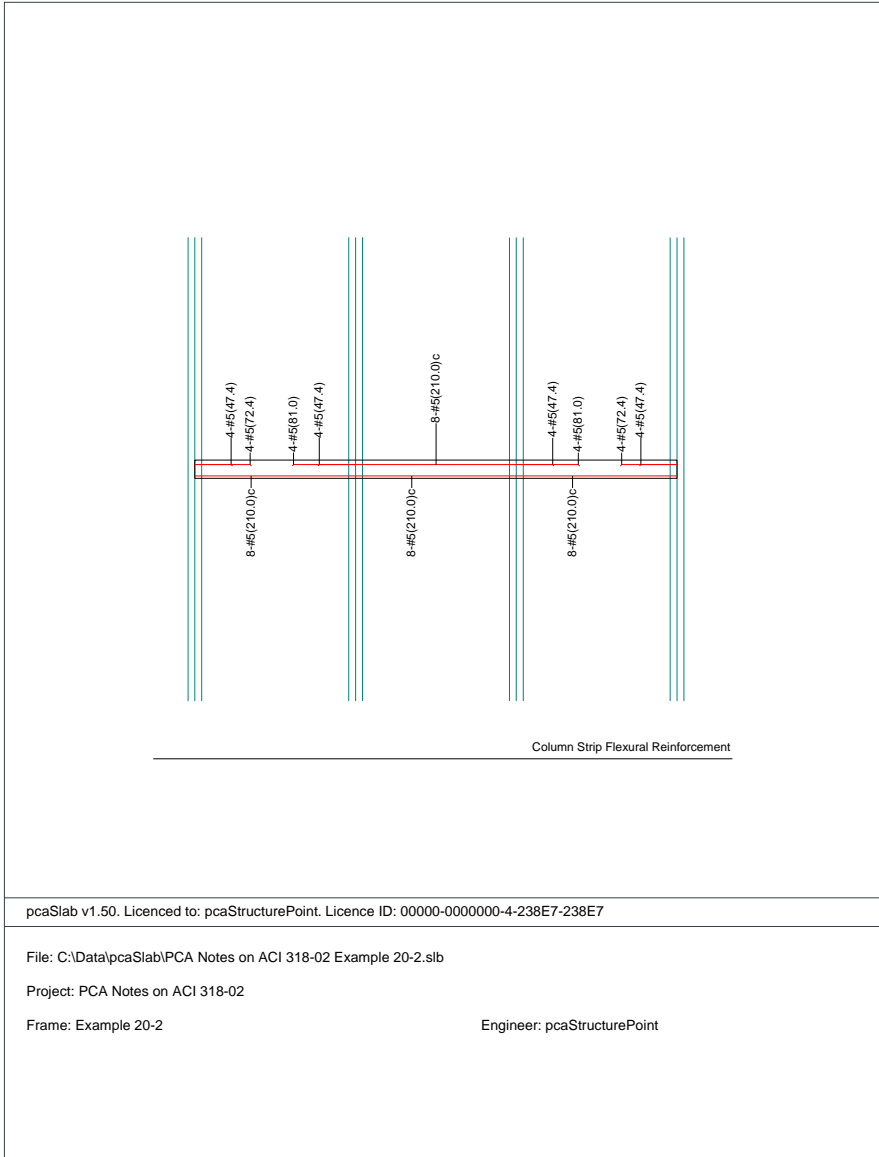

Appendix

Conversion Factors - English to SI

To convert from	To	Multiply by
in.	m (1000 mm)	0.025400
ft	m	0.304800
lb	N (0.001 kN)	4.448222
kip (1000 lbs)	kN	4.448222
plf (lb/ft)	N/m	14.593904
psi (lb/in. ²)	kPa	6.894757
ksi (kips/in. ²)	MPa	6.894757
psf (lb/ft ²)	N/m ² (Pa)	47.88026
pcf (lb/ft ³)	kg/m ³	16.018460
ft-kips	kN • m	1.355818

Conversion Factors - SI to English.

To convert from	To	Multiply by
m (1000 mm)	in	39.37008
m	ft	3.28084
N (0.001 kN)	lb	0.224809
kN	kip (1000 lbs)	0.224809
kN/m	Plf (lb/ft)	68.52601
MPa	Psi (lb/in. ²)	145.0377
MPa	ksi (kips/in. ²)	0.145038
kN/m ² (kPa)	Psf (lb/ft ²)	20.88555
kg/m ³	Pcf (lb/ft ³)	0.062428
kN • m	ft-kips	0.737562

Contact Information

Web Site: <http://www.pcaStructurePoint.com>

E-mail: info@pcaStructurePoint.com
support@pcaStructurePoint.com

Ordering: pcaStructurePoint
 5420 Old Orchard Road
 Skokie, IL 60077
 USA

Phone: (847) 966-4357

Fax: (847) 581-0644

Technical Support: pcaStructurePoint
 5420 Old Orchard Road
 Skokie, IL 60077
 USA

Phone: (847) 966-HELP / (847) 966-4357

Fax: (847) 581-0644

Bug Report Form

To help us improve our products please fax, mail or e-mail questions to:

pcaStructurePoint
 5420 Old Orchard Road
 Skokie, IL 60077
 Fax: (847) 581-0644
 E-mail: support@pcaStructurePoint.com

Program Name		Company Name	
Program Version		Tester's Name	
Program Release		Phone	
Operating System		Fax	
CPU / Memory		E-mail	
Network		Input File	
Bug No.		Output File	
Date		Screen Shot File	
Bug Priority Category			

<p>Problem Title <i>Please enter a brief, one-line description of the problem.</i></p>
<p>Summary Information <i>Restate the problem title and/or include more descriptive summary information.</i></p>
<p>Error Messages <i>If the problem causes any error messages, please list the exact error messages that you are receiving.</i></p>
<p>Steps to Reproduce <i>If the problem is reproducible, please list the steps required to cause it. If the problem is not reproducible (only happened once, or occasionally for no apparent reason), please describe the circumstances in which it occurred and the symptoms observed.</i></p>
<p>Results <i>Describe your results and how they differed from what you expected.</i></p>
<p>Workaround <i>If there is a workaround for the problem, please describe it in detail.</i></p>
<p>Documentation & Notes <i>Document any additional information that might be useful in resolving the problem.</i></p>

